



US00D552632S

(12) **United States Design Patent**
De Martiis

(10) **Patent No.:** **US D552,632 S**
(45) **Date of Patent:** **** Oct. 9, 2007**

(54) **TOOTH ASSEMBLY FOR BUCKETS**

(57) **CLAIM**

(75) Inventor: **Giancarlo De Martiis**, Pagnacco (IT)

The ornamental design for a tooth assembly for buckets, as shown and described.

(73) Assignee: **Italricambi Srl**, Cividale Del Friuli (UD) (IT)

(**) Term: **14 Years**

(21) Appl. No.: **29/277,772**

(22) Filed: **Mar. 9, 2007**

Related U.S. Application Data

(62) Division of application No. 29/211,001, filed on Aug. 10, 2004.

(30) **Foreign Application Priority Data**

Feb. 10, 2004 (EM) 141296
Jul. 20, 2004 (EM) 203617

(51) **LOC (8) Cl.** **15-03**

(52) **U.S. Cl.** **D15/29**

(58) **Field of Classification Search** D15/10,
D15/25, 28, 29, 32; 172/699, 713; 37/446,
37/458, 452-454, 455, 450, 903, 142 R,
37/142 A, 141 R, 141 T; 403/355

See application file for complete search history.

(56) **References Cited**

U.S. PATENT DOCUMENTS

1,571,782 A 2/1926 Andrews

(Continued)

FOREIGN PATENT DOCUMENTS

EP 0835963 A1 4/1998

Primary Examiner—Stella Reid

Assistant Examiner—Mark Goodwin

(74) *Attorney, Agent, or Firm*—Akin Gump Strauss Hauer & Feld LLP

DESCRIPTION

FIG. 1 is a front elevational view of a tooth assembly for buckets in accordance with my new design;

FIG. 2 is a right-side elevational view thereof;

FIG. 3 is a left-side elevational view thereof;

FIG. 4 is a rear elevational view thereof;

FIG. 5 is a top plan view thereof;

FIG. 6 is a bottom plan view thereof;

FIG. 7 is a perspective view thereof;

FIG. 8 is a front elevational view of a first tooth of the tooth assembly for buckets shown in FIGS. 1-7, FIGS. 8-14 show the first tooth in the unassembled condition for ease of illustration;

FIG. 9 is a right-side elevational view thereof;

FIG. 10 is a left-side elevational view thereof;

FIG. 11 is a rear elevational view thereof;

FIG. 12 is a top plan view thereof;

FIG. 13 is a bottom plan view thereof;

FIG. 14 is a perspective view thereof;

FIG. 15 is a front elevational view of a second tooth of the tooth assembly for buckets shown in FIGS. 1-7, FIGS. 15-21 show the second tooth in the unassembled condition for ease of illustration;

FIG. 16 is a right-side elevational view thereof;

FIG. 17 is a left-side elevational view thereof;

FIG. 18 is a rear elevational view thereof;

FIG. 19 is a top plan view thereof;

FIG. 20 is a bottom plan view thereof; and,

FIG. 21 is a perspective view thereof.

The broken lines in the figures are for illustrative purposes only and form no part of the claimed design.

1 Claim, 6 Drawing Sheets

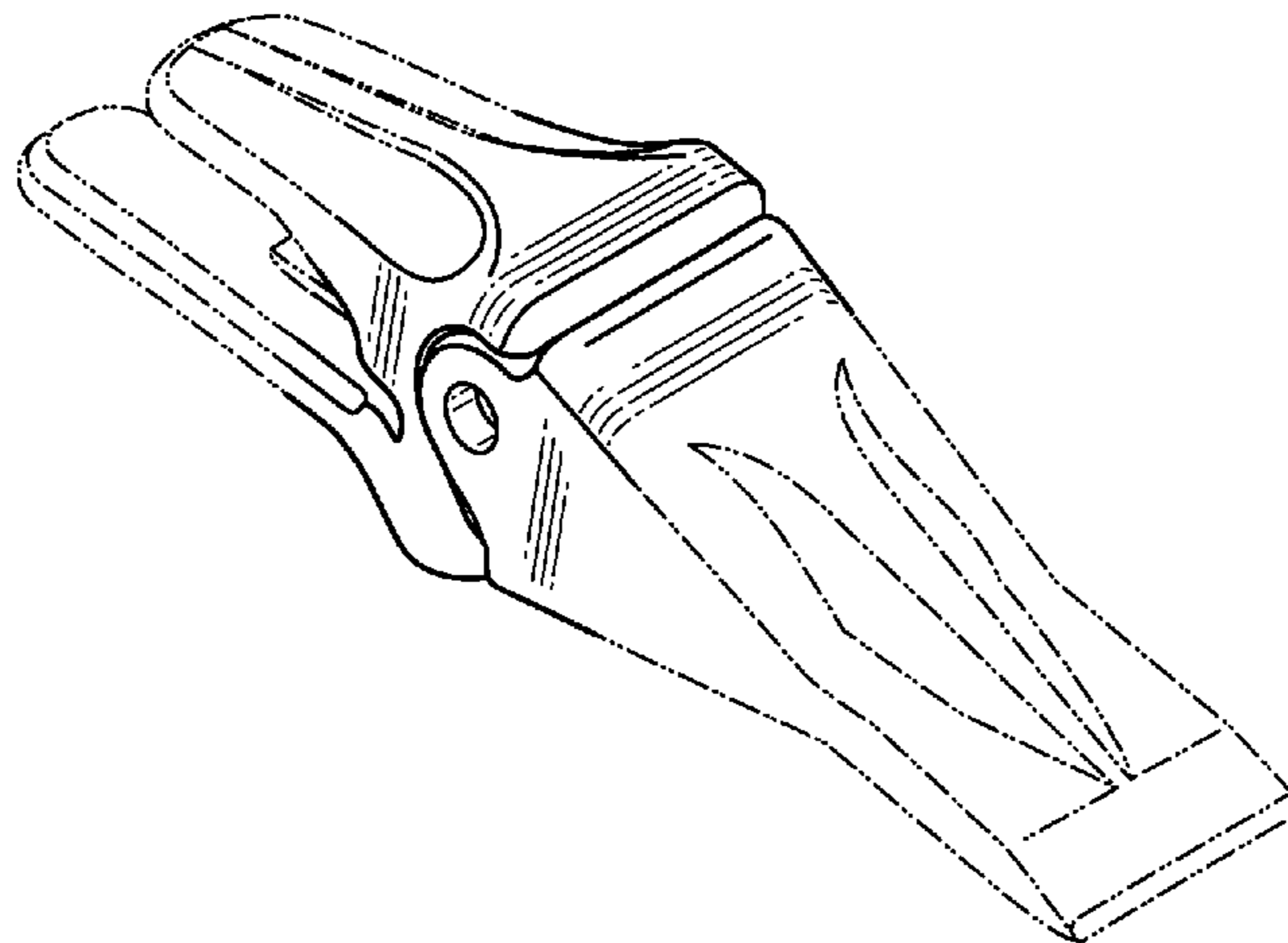

US D552,632 S

U.S. PATENT DOCUMENTS					
			D385,286 S	10/1997	Moreno
1,856,930 A	5/1932	Robin	5,709,043 A	1/1998	Jones et al.
3,325,926 A *	6/1967	Wilson 37/458	D391,584 S	3/1998	Moreno
3,371,437 A	3/1968	Wilson et al.	D392,292 S	3/1998	Moreno
3,444,633 A	5/1969	Hensley	5,782,019 A	7/1998	Lauder et al.
3,601,911 A	8/1971	Wood	D410,657 S	6/1999	Lauder et al.
3,812,608 A	5/1974	Ratkowski	D413,338 S	8/1999	Molina
3,823,496 A	7/1974	Querci et al.	5,937,551 A	8/1999	Moehnke et al.
3,851,413 A	12/1974	Lukavich	D417,877 S	12/1999	Lauder et al.
4,027,408 A	6/1977	Ramella et al.	D420,014 S	2/2000	Karlsson
D251,431 S	3/1979	Klett et al.	D429,256 S	8/2000	Zaun
D251,667 S	4/1979	Lemcke	D446,224 S	8/2001	Clendenning
D252,461 S	7/1979	Korpi	D447,154 S	8/2001	Clendenning
4,231,173 A	11/1980	Davis	6,321,471 B2	11/2001	Munoz et al.
D275,859 S	10/1984	Nilsson	6,477,796 B1	11/2002	Cornelius
D297,643 S	9/1988	Mohlin	D471,212 S	3/2003	Rodriguez
D336,304 S	6/1993	Robinson	D471,565 S	3/2003	Rodriguez
D336,476 S	6/1993	Garman	6,735,890 B2	5/2004	Carpenter et al.
D339,592 S	9/1993	Johansson	6,766,602 B2	7/2004	Cox et al.
5,386,653 A	2/1995	Cornelius	D499,749 S	12/2004	Lauder et al.
5,423,138 A	6/1995	Livesay et al.	6,836,983 B2 *	1/2005	Pallas Moreno et al. 37/452
5,456,029 A	10/1995	Cornelius	6,865,828 B1 *	3/2005	Molino et al. 37/454
5,469,648 A	11/1995	Jones et al.	2004/0010949 A1	1/2004	Laguarda et al.
5,561,925 A *	10/1996	Livesay 37/455			

* cited by examiner

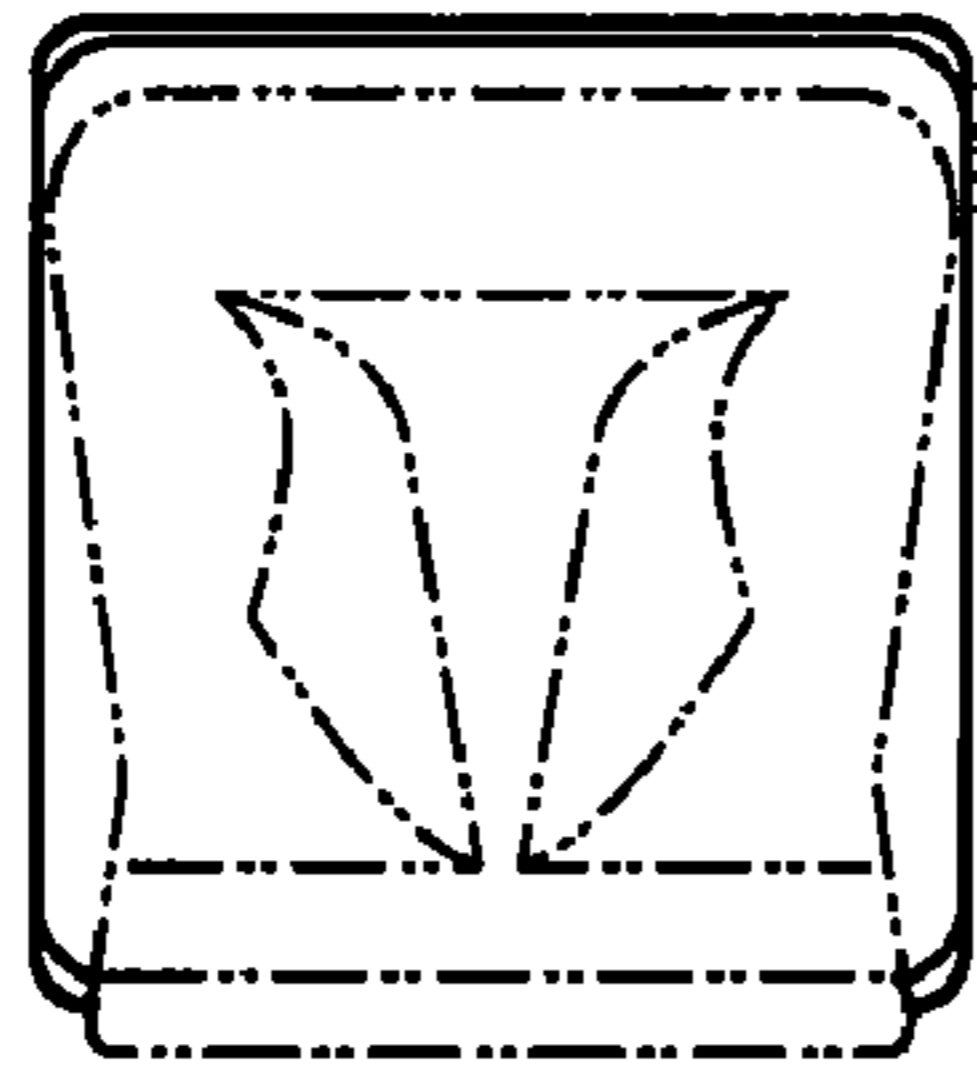

FIG. 1

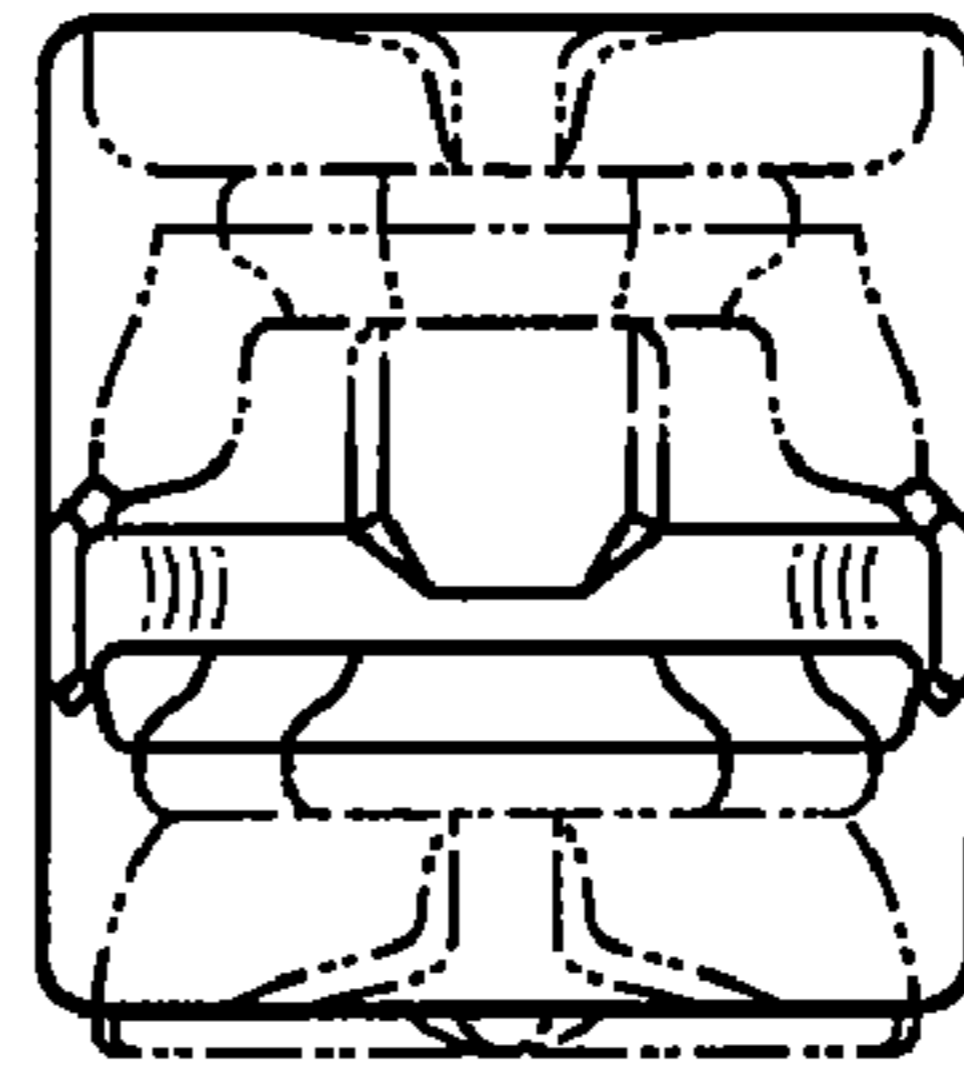

FIG. 4

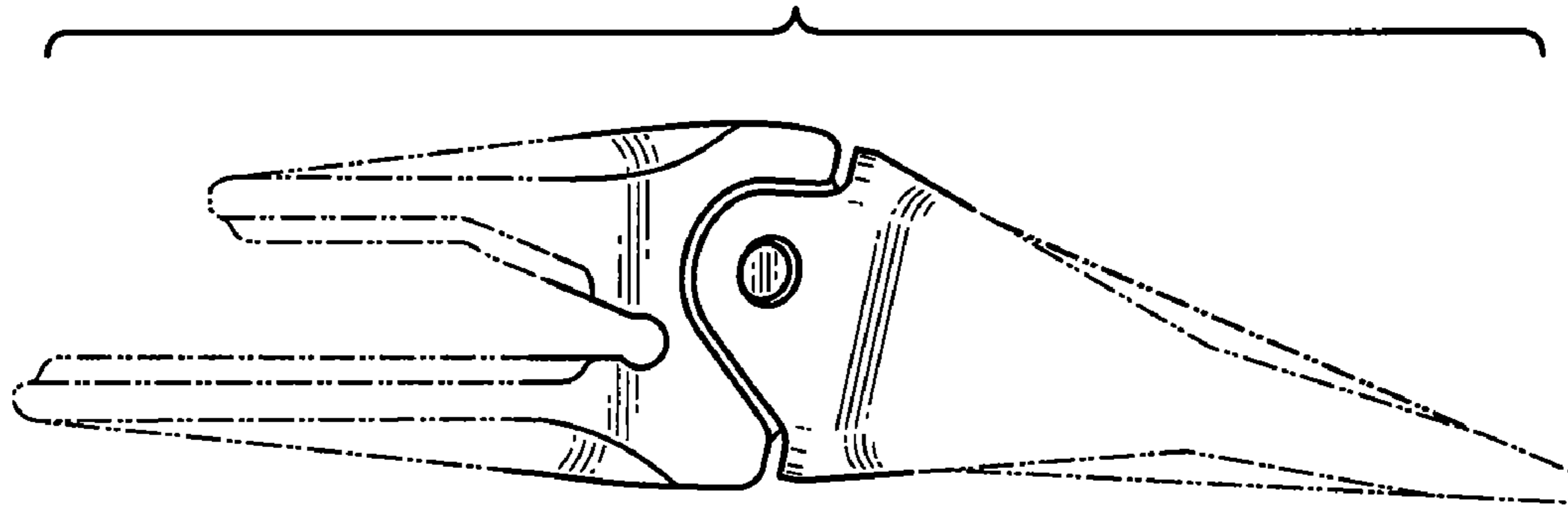

FIG. 2

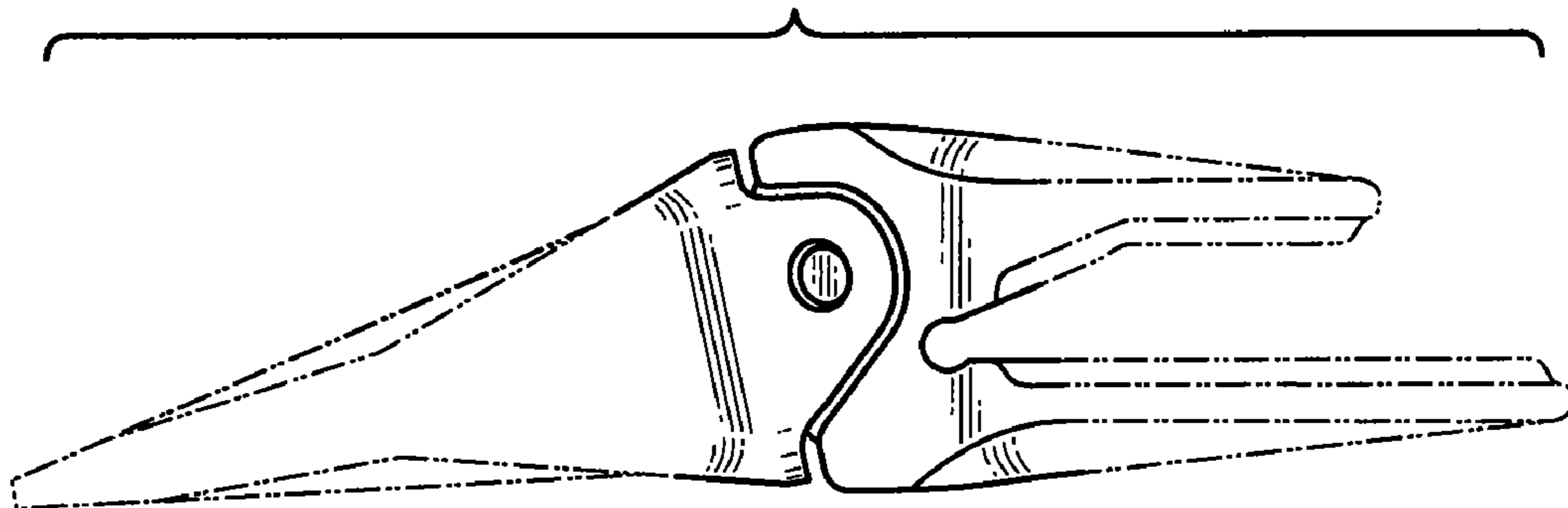

FIG. 3

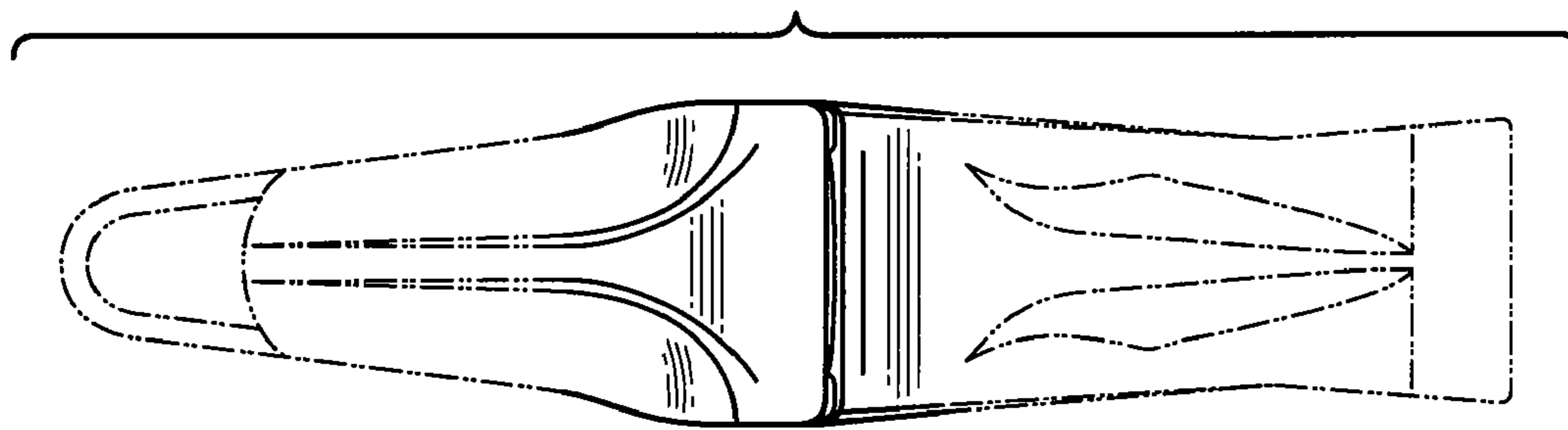

FIG. 5

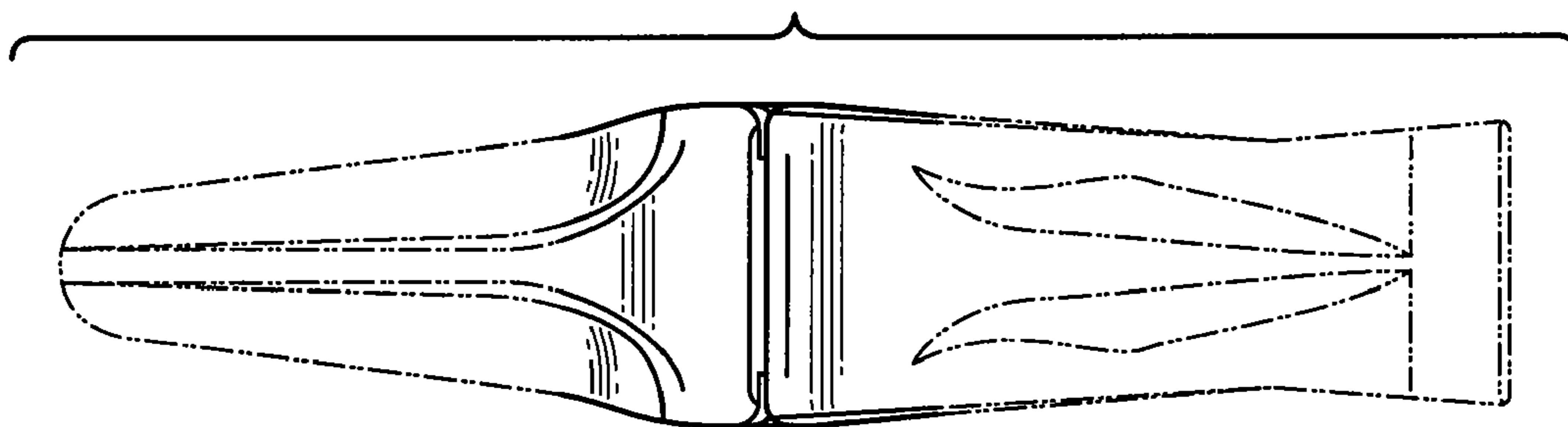

FIG. 6

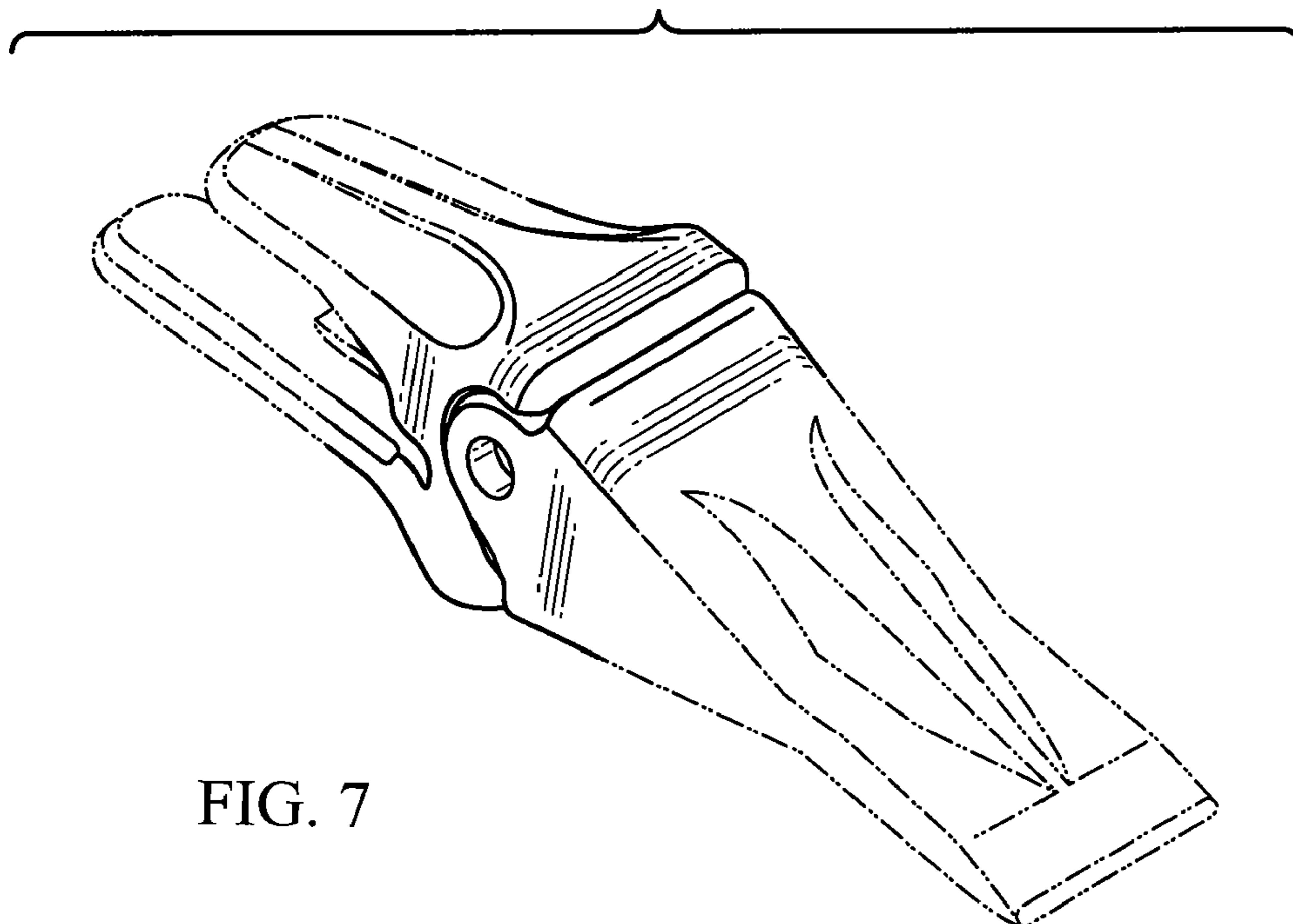

FIG. 7

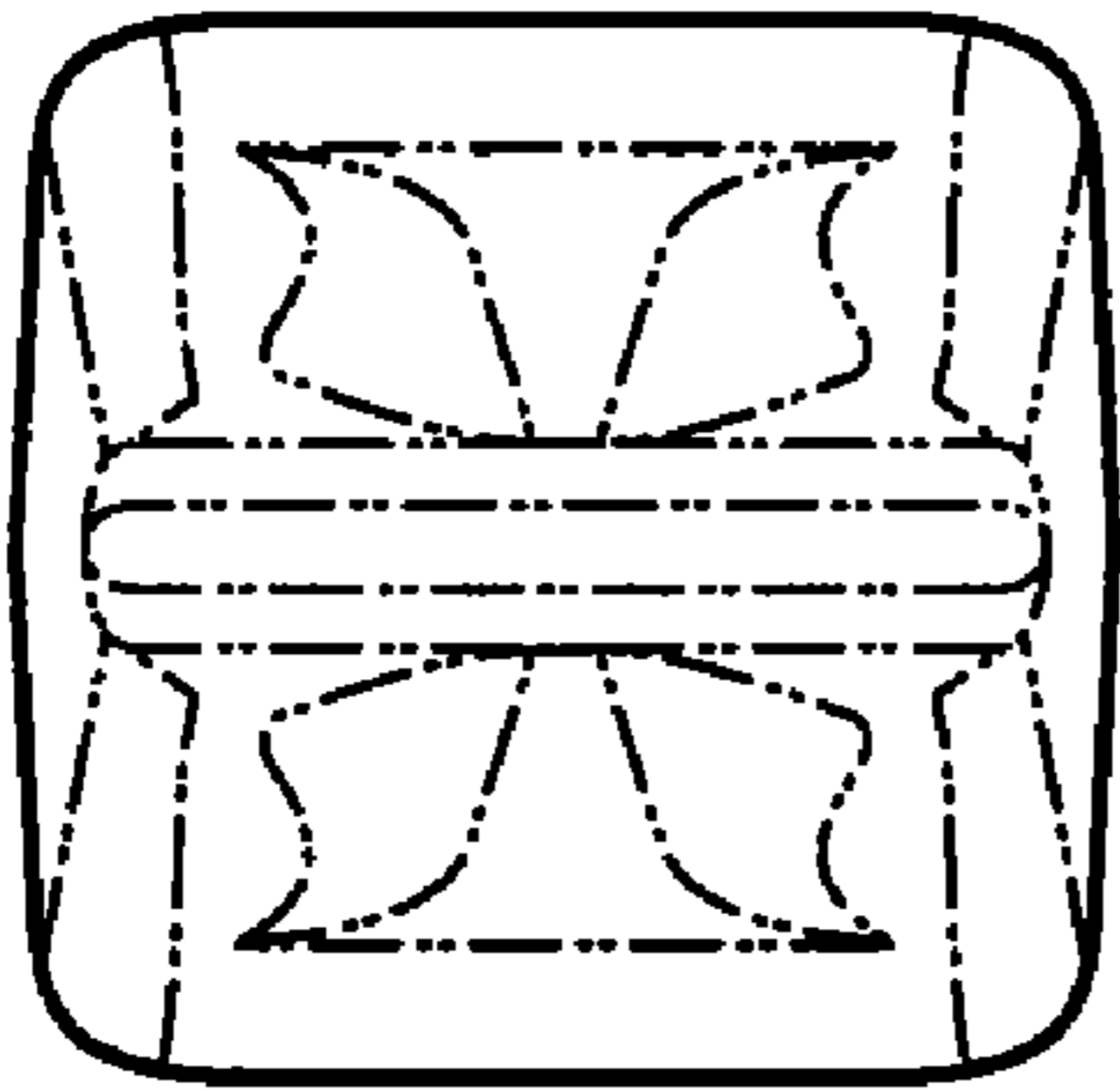

FIG. 8

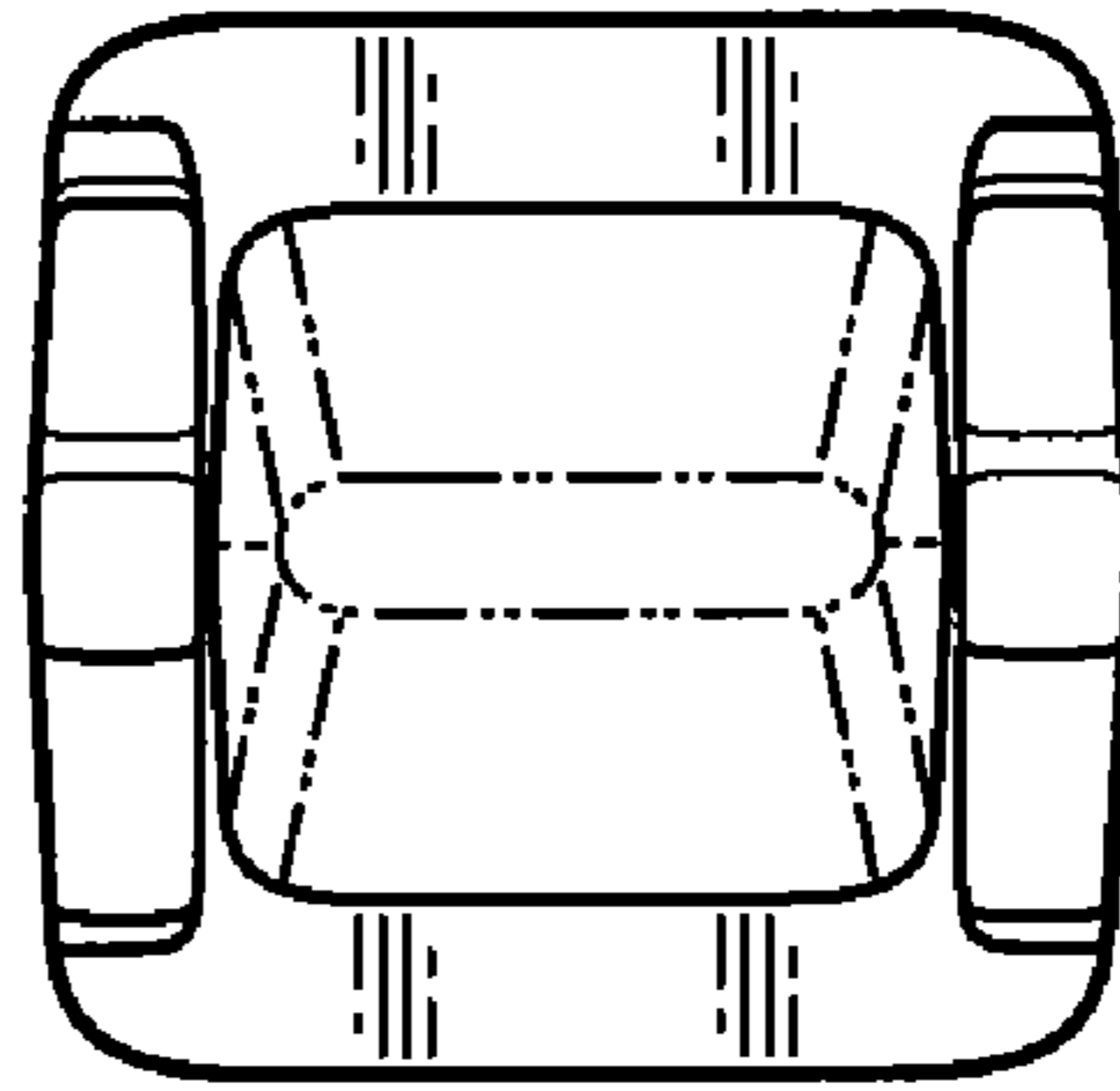

FIG. 11

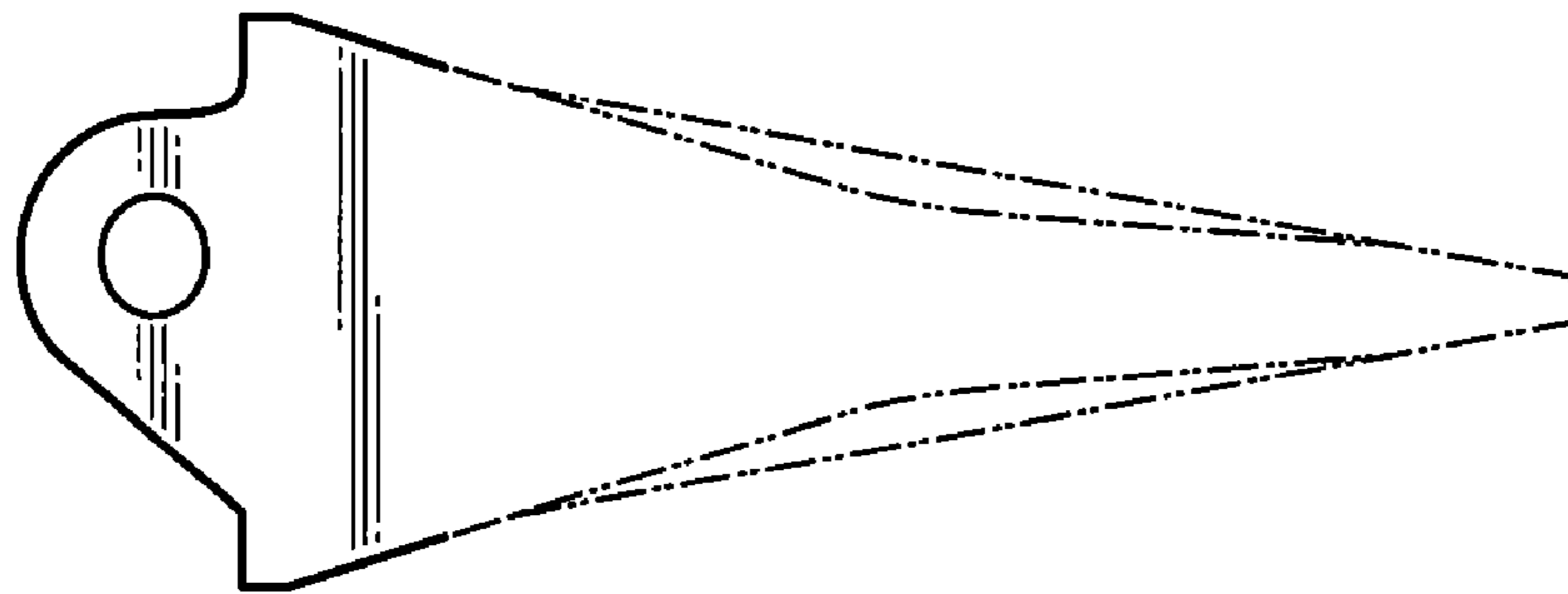

FIG. 9

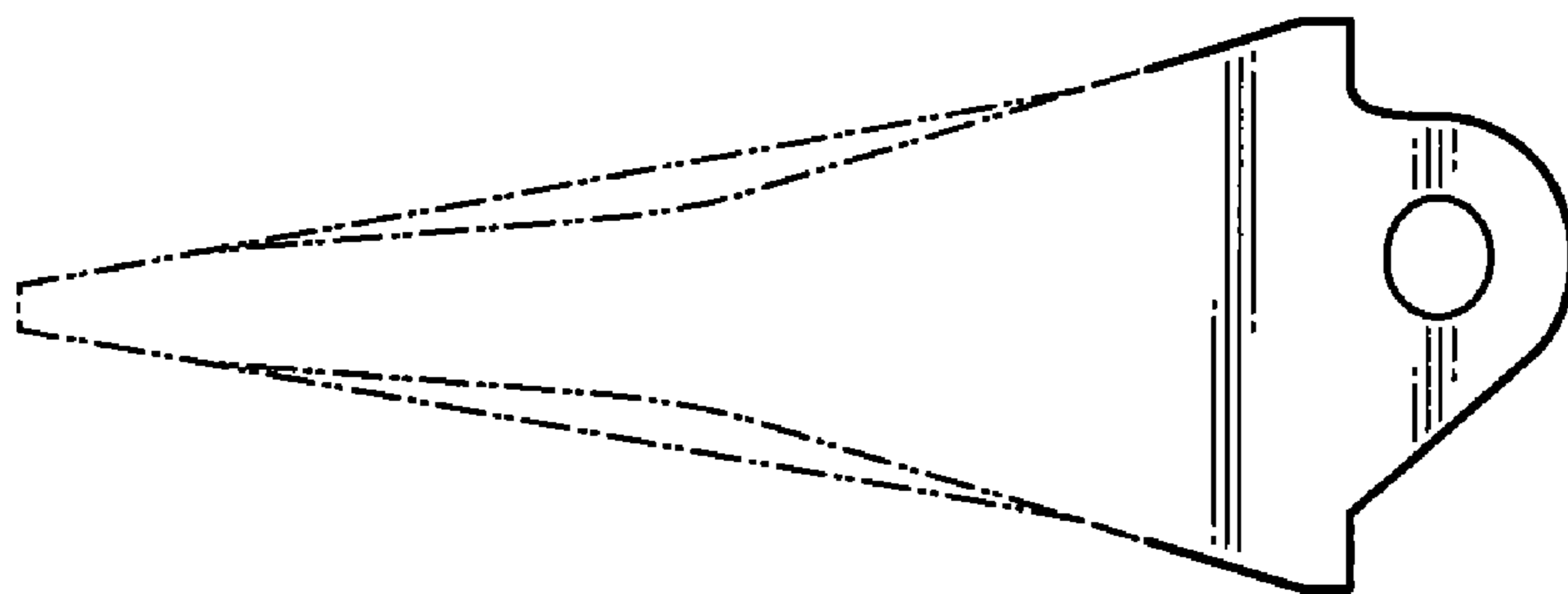

FIG. 10

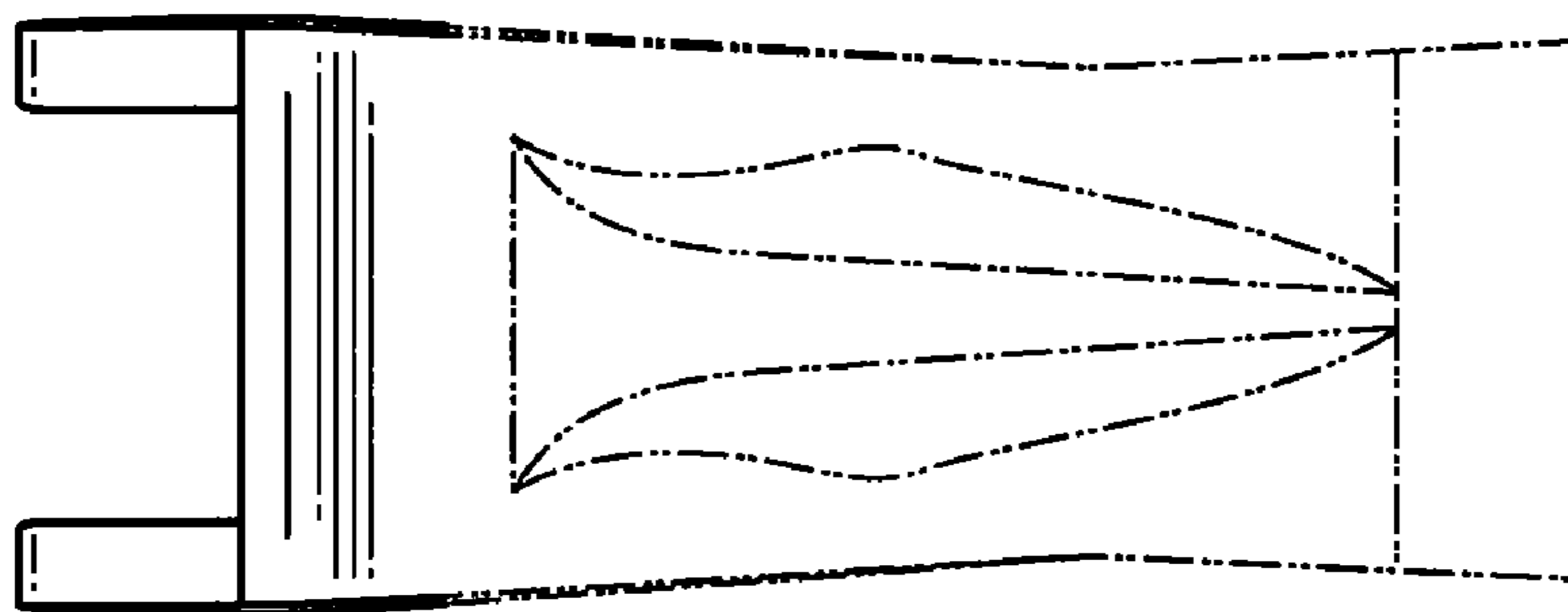

FIG. 12

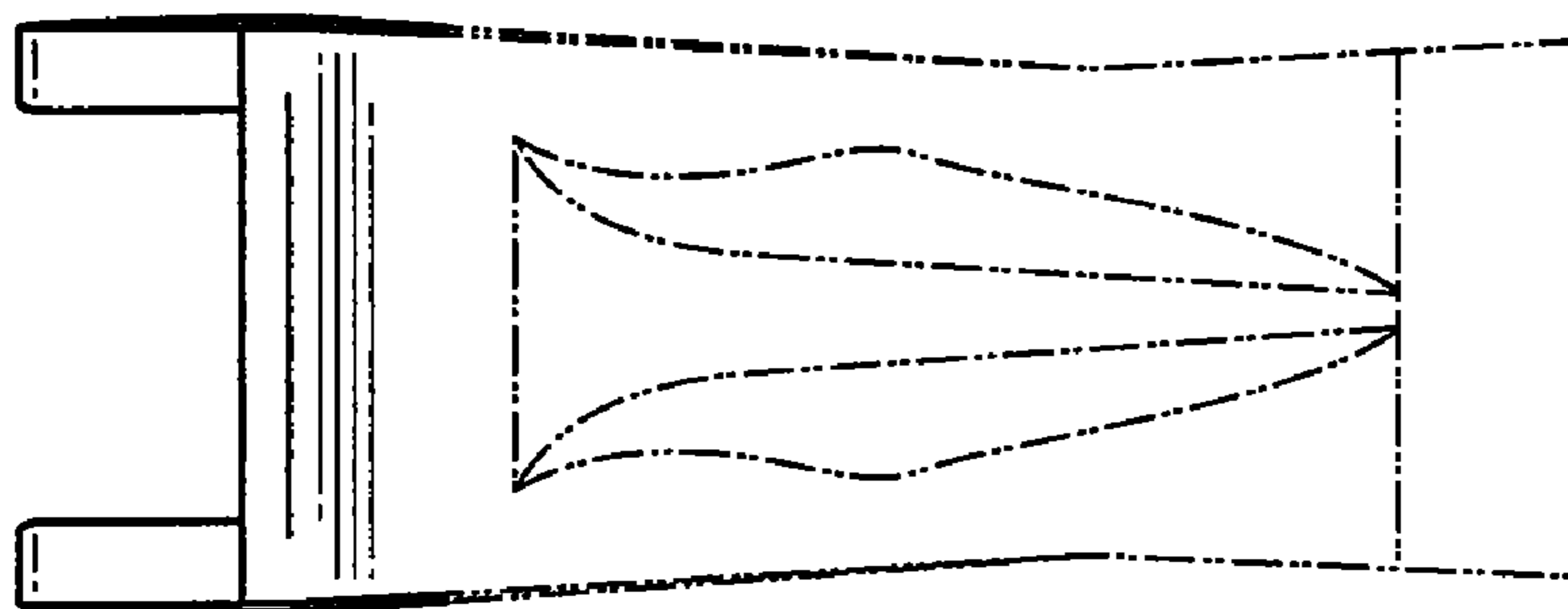

FIG. 13

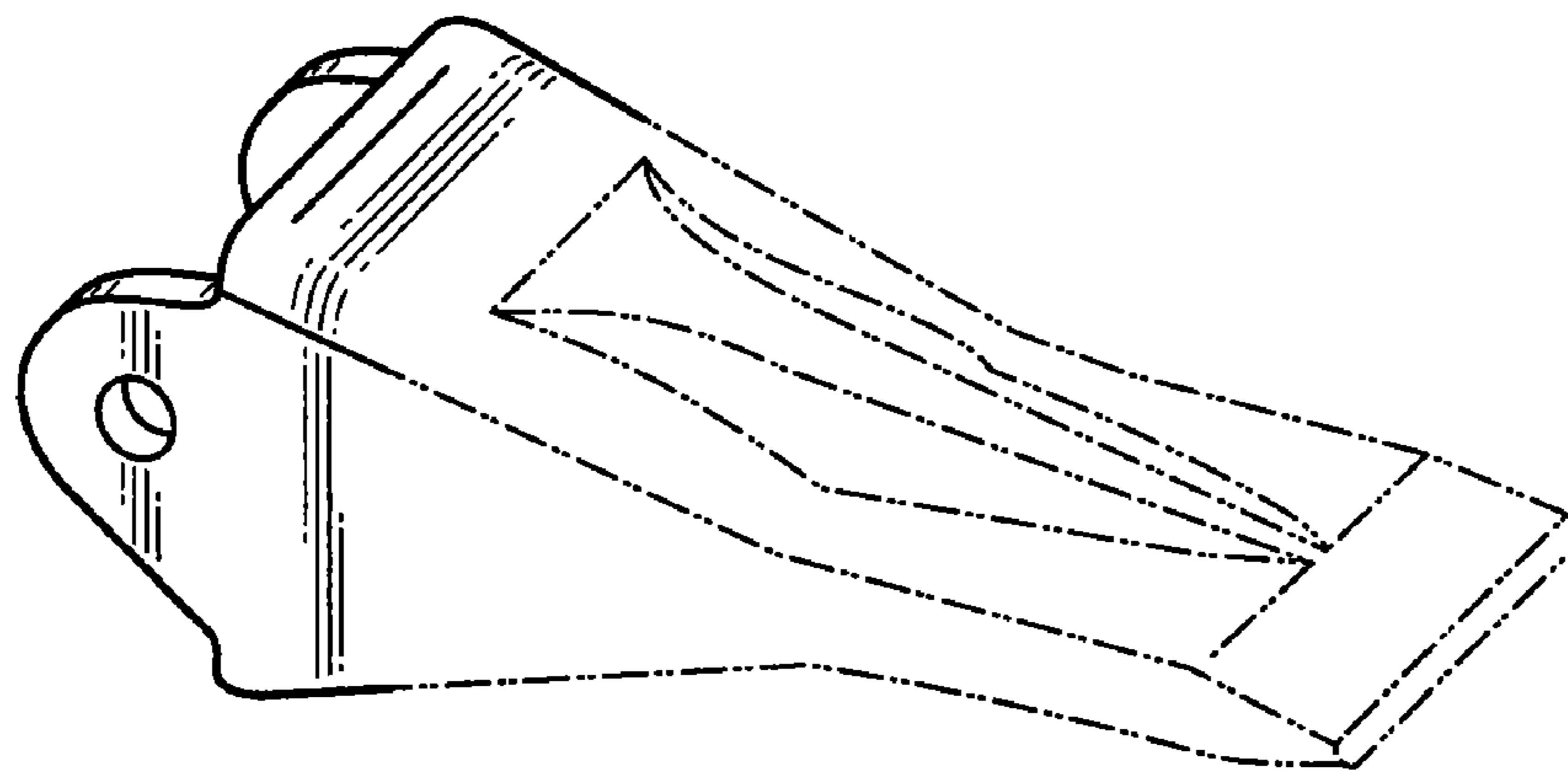

FIG. 14

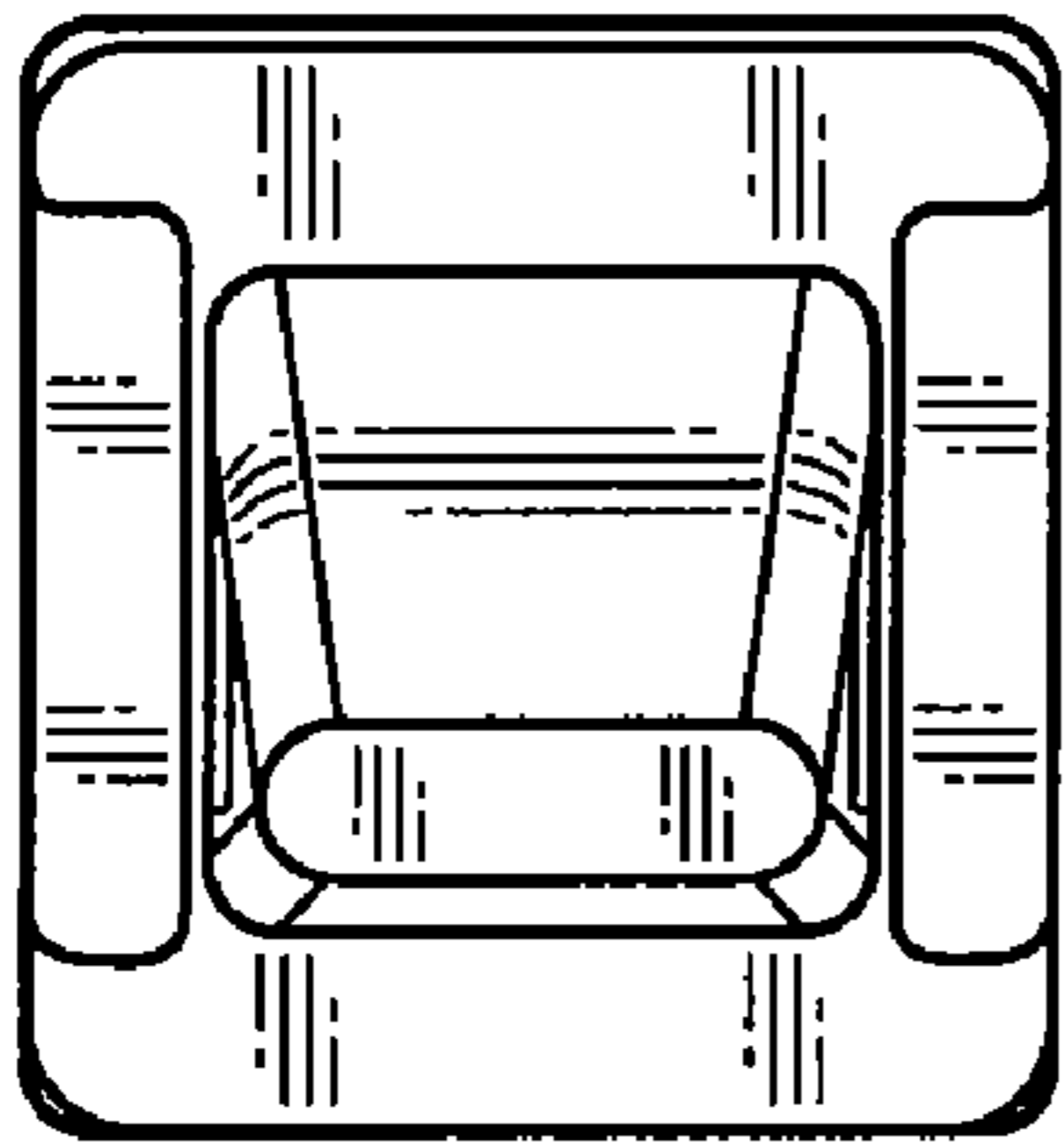

FIG. 15

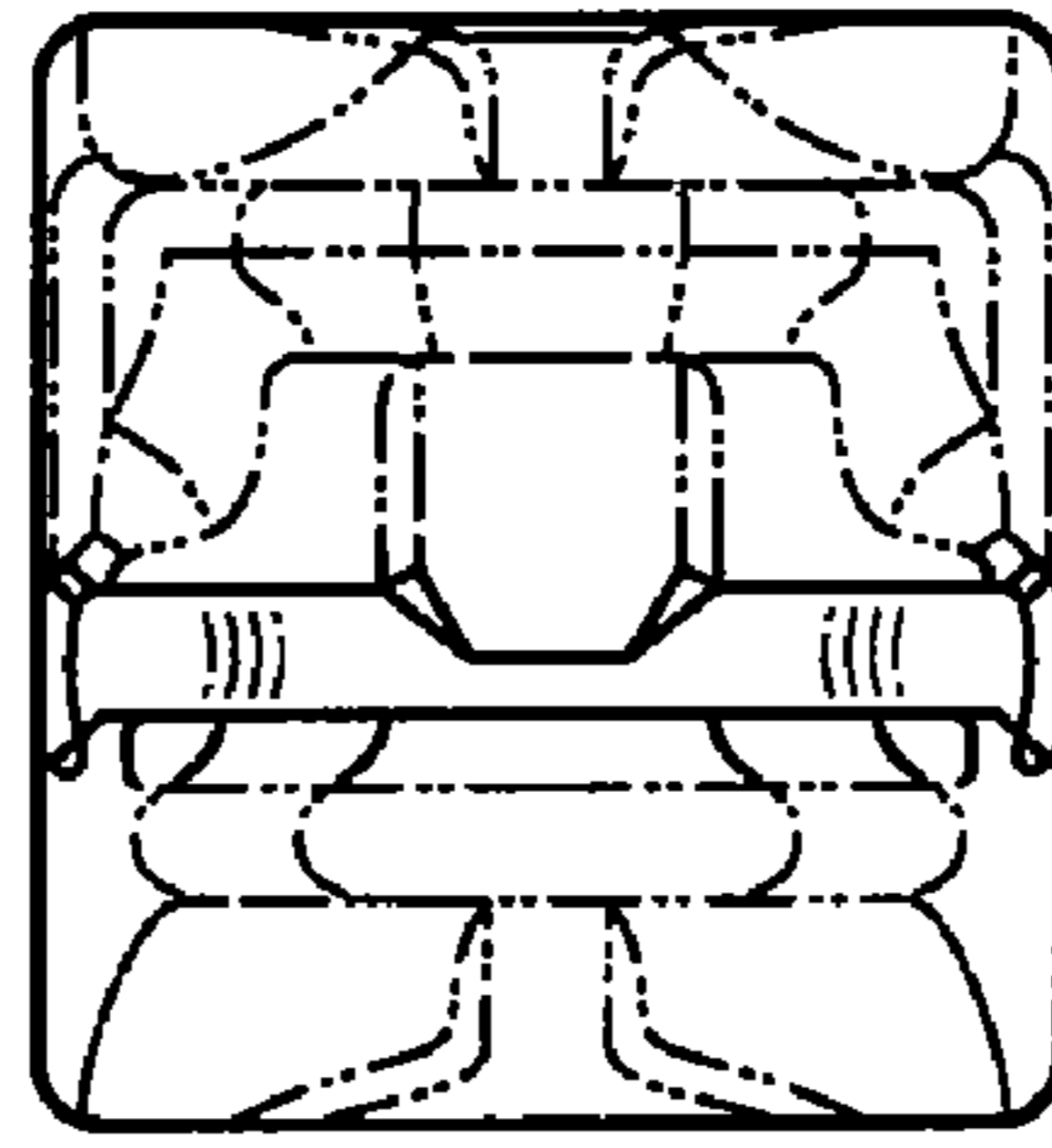

FIG. 18

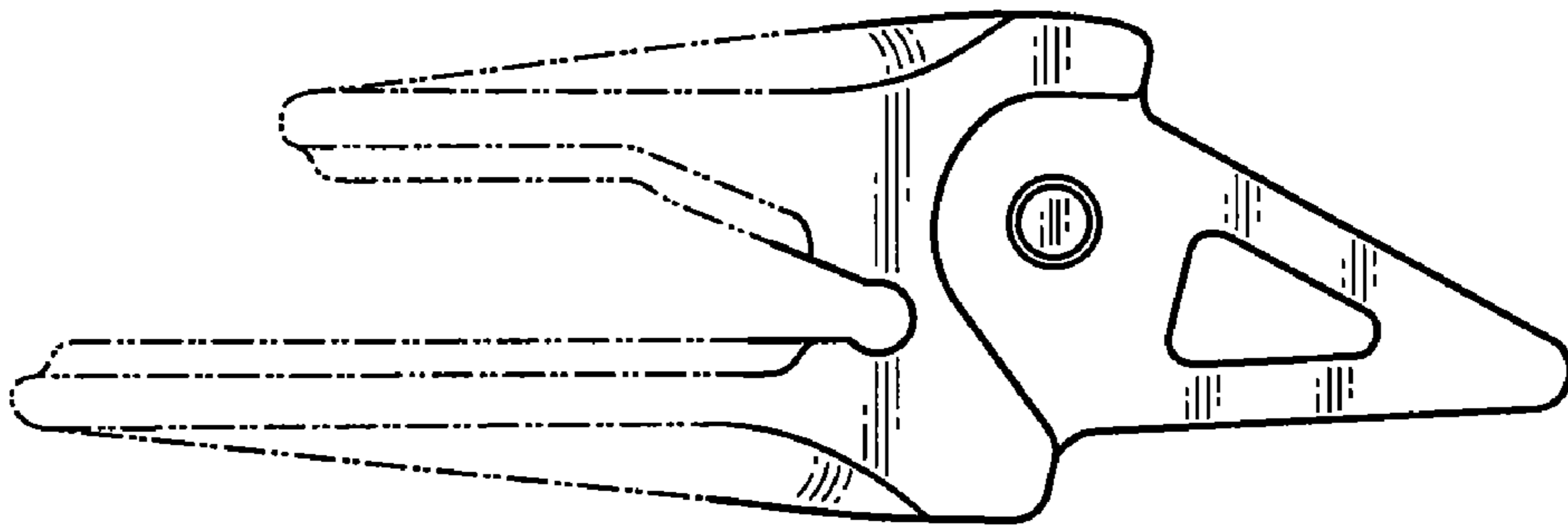

FIG. 16

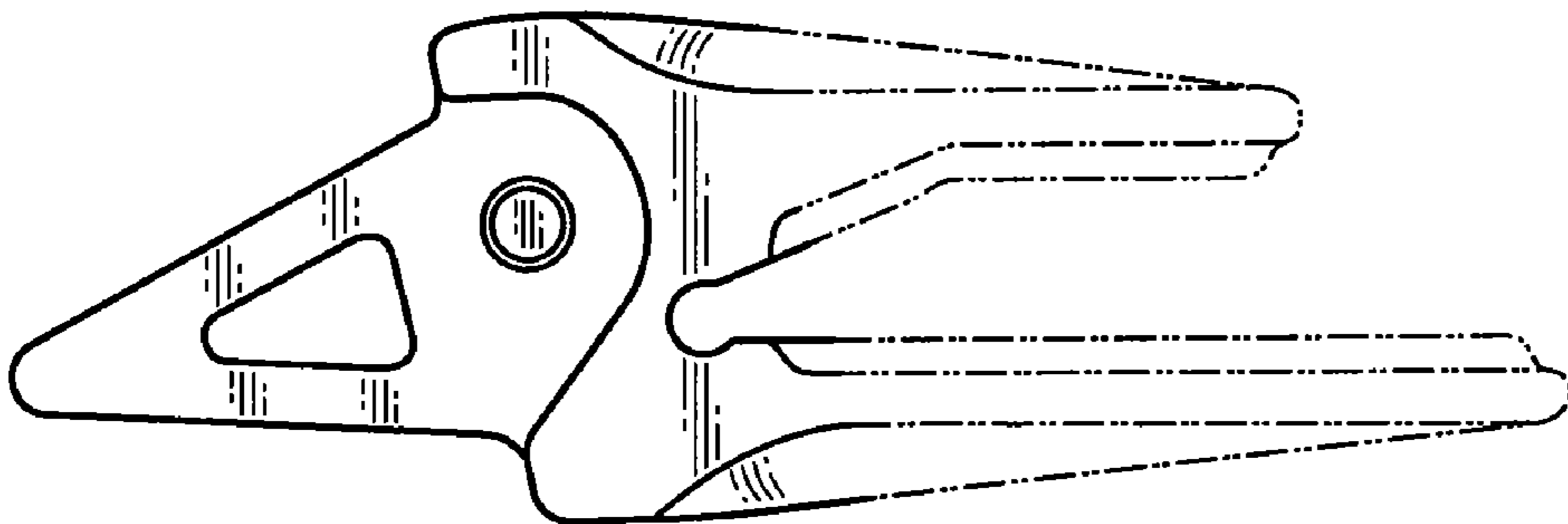

FIG. 17

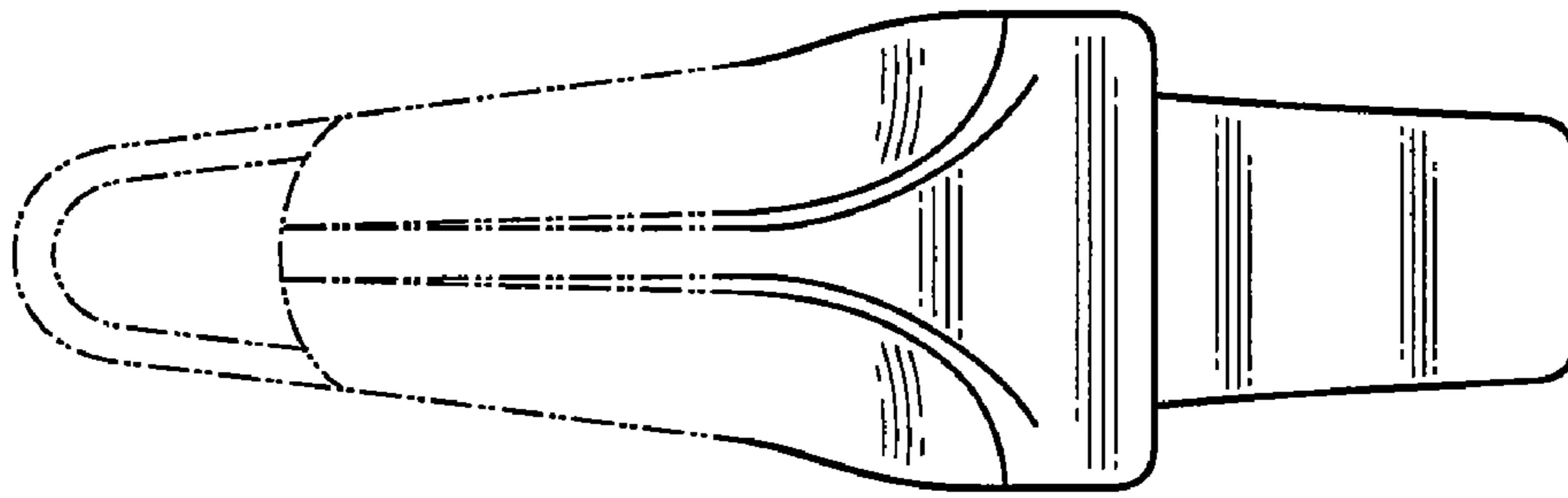

FIG. 19

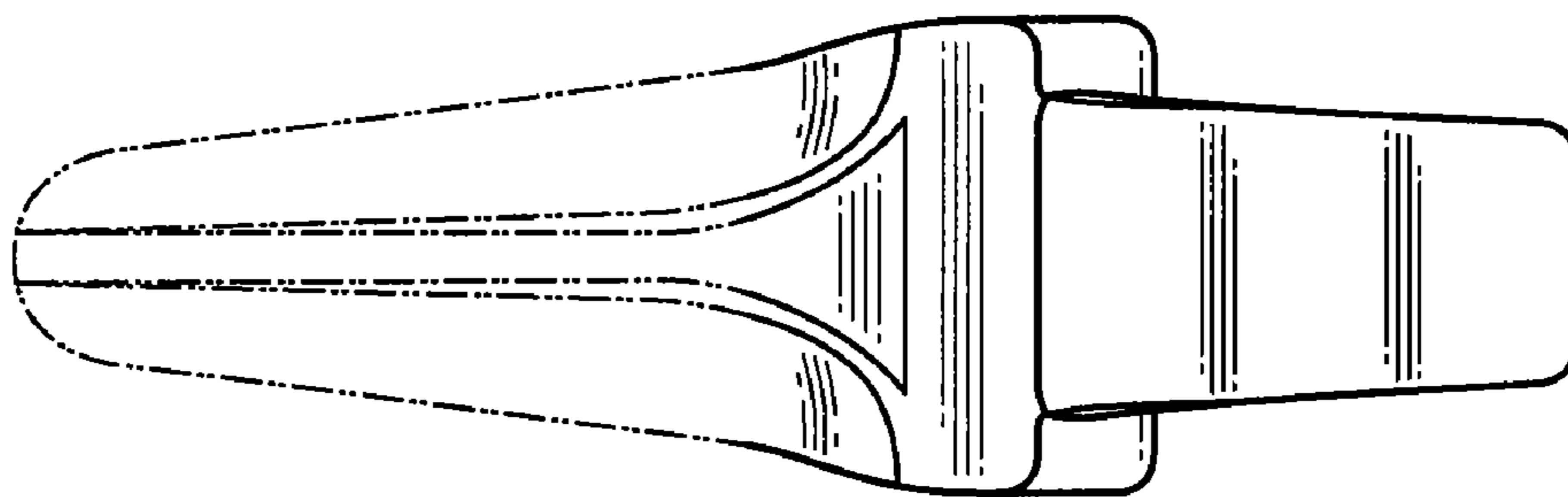

FIG. 20

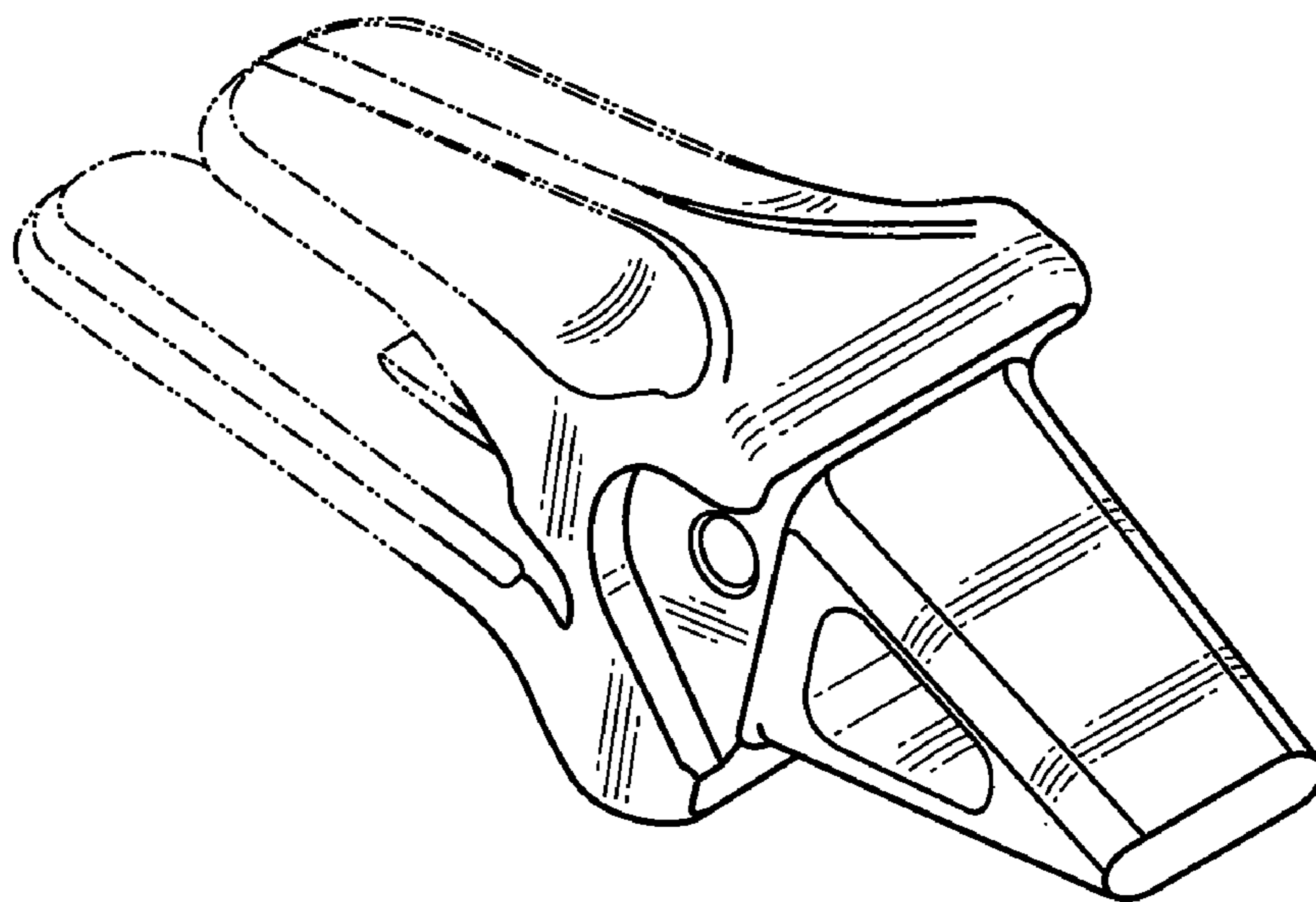

FIG. 21