

US00D552577S

(12) **United States Design Patent**
Kim et al.

(10) **Patent No.:** **US D552,577 S**
(45) **Date of Patent:** **** Oct. 9, 2007**

(54) **PORTABLE PHONE**

(75) Inventors: **Kang-Moon Kim**, Seoul (KR); **Jin-Soo Kim**, Yongin-si (KR); **Nam-Mi Kim**, Seoul (KR); **Chang-Hwan Hwang**, Goyang-si (KR)

(73) Assignee: **Samsung Electronics Co., Ltd.**, Suwon-Si (KR)

(**) Term: **14 Years**

(21) Appl. No.: **29/242,760**

(22) Filed: **Nov. 15, 2005**

(30) **Foreign Application Priority Data**

May 20, 2005 (KR) 30-2005-0016879

(51) **LOC (8) Cl.** **14-03**

(52) **U.S. Cl.** **D14/138**

(58) **Field of Classification Search** D14/138,
D14/341-347, 147-148, 496; 379/433.01-433.13;
455/575.3, 575.4, 566, 575.1, 556.1, 556.2,
455/90.3

See application file for complete search history.

(56) **References Cited**

U.S. PATENT DOCUMENTS

D501,457 S *	2/2005	Lee et al.	D14/138
D502,458 S *	3/2005	Chung et al.	D14/138
D506,454 S *	6/2005	Kim et al.	D14/138
D509,816 S *	9/2005	Kim et al.	D14/138
D510,078 S *	9/2005	Lee et al.	D14/138
D510,079 S *	9/2005	Kim et al.	D14/138
D510,733 S *	10/2005	Lee et al.	D14/138
D512,038 S *	11/2005	Kim et al.	D14/138
D512,397 S *	12/2005	Choi et al.	D14/138
D518,015 S *	3/2006	Cho	D14/138
D518,465 S *	4/2006	Van Den Nieuwenhuizen et al. .	D14/138
D519,970 S *	5/2006	Kang et al.	D14/138
D519,973 S *	5/2006	Chung et al.	D14/138
D520,486 S *	5/2006	Kim et al.	D14/138

D520,981 S *	5/2006	Lee et al.	D14/138
D535,963 S *	1/2007	Koh et al.	D14/138
D537,430 S *	2/2007	Lee	D14/138
2005/0186985 A1 *	8/2005	Im et al.	455/550.1

FOREIGN PATENT DOCUMENTS

WO DM/064560 * 10/2003

OTHER PUBLICATIONS

Samsung S501i telephone, announced Jul. 2006, [online], [retrieved on Mar. 29, 2007]. Retrieved from Internet, <URL: http://www.gsmarena.com>.*

Philips S880 telephone, announced Jun. 2006, [online], [retrieved on Mar. 30, 2007]. Retrieved from Internet, <URL: http://www.gsmarena.com>.*

Sony Ericsson Z310 telephone, announced Dec. 2006, [online], [retrieved on Apr. 14, 2007]. Retrieved from Internet, <URL: http://www.gsmarena.com>.*

Asus M303 telephone, announced Mar. 2006, [online], [retrieved on Apr. 14, 2007]. Retrieved from Internet, <URL: http://www.gsmarena.com>.*

* cited by examiner

Primary Examiner—Jeffrey Asch

(74) *Attorney, Agent, or Firm*—Staas & Halsey LLP

(57) **CLAIM**

The ornamental design for the portable phone, as shown and described.

DESCRIPTION

FIG. 1 is a perspective view of the portable phone showing our design;

FIG. 2 is a front view thereof;

FIG. 3 is a rear view thereof;

FIG. 4 is a left side view thereof;

FIG. 5 is a right side view thereof;

FIG. 6 is a top plan view thereof;

FIG. 7 is a bottom plan view thereof; and,

FIG. 8 is a front, open view thereof.

1 Claim, 7 Drawing Sheets

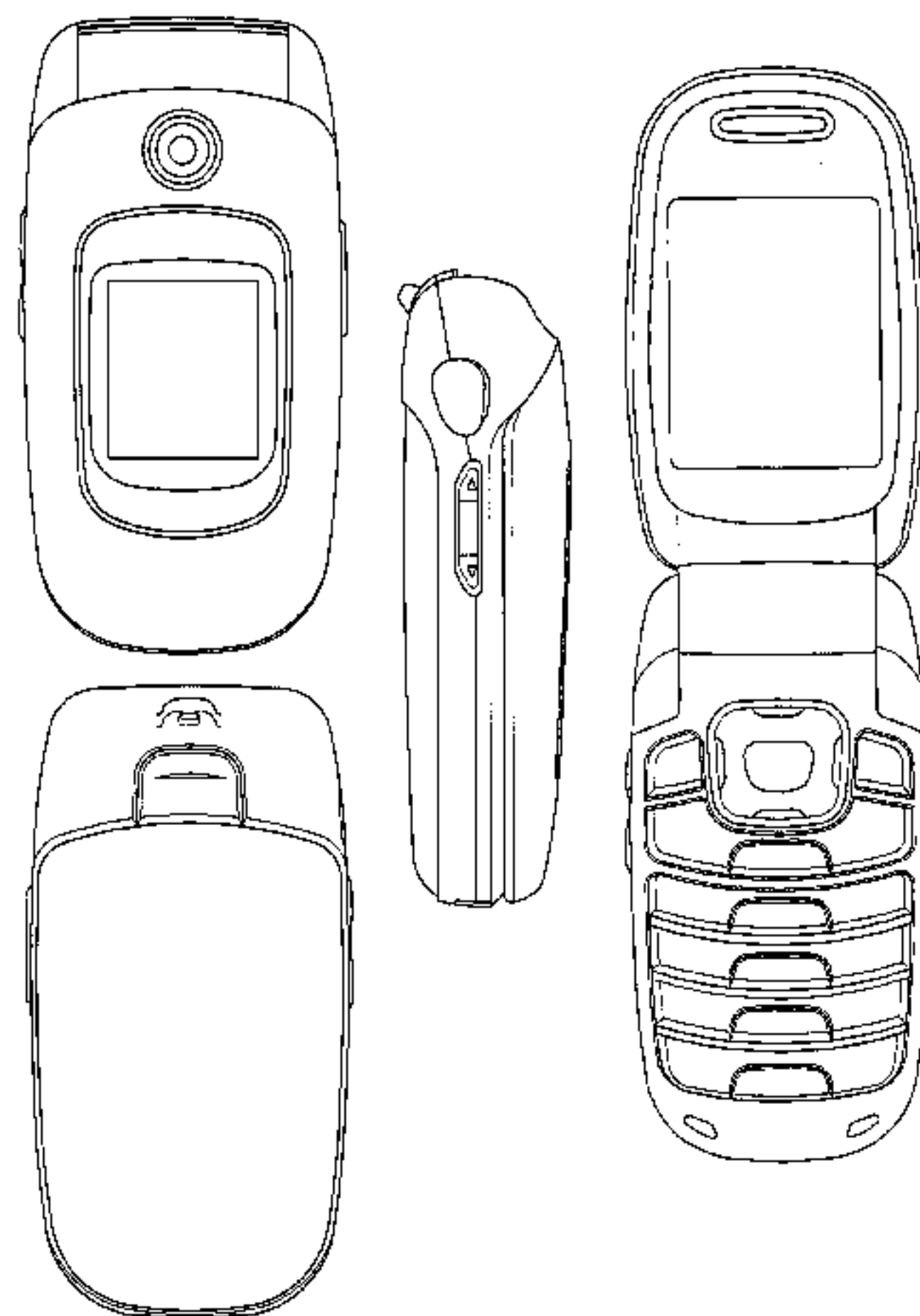

FIG. 1

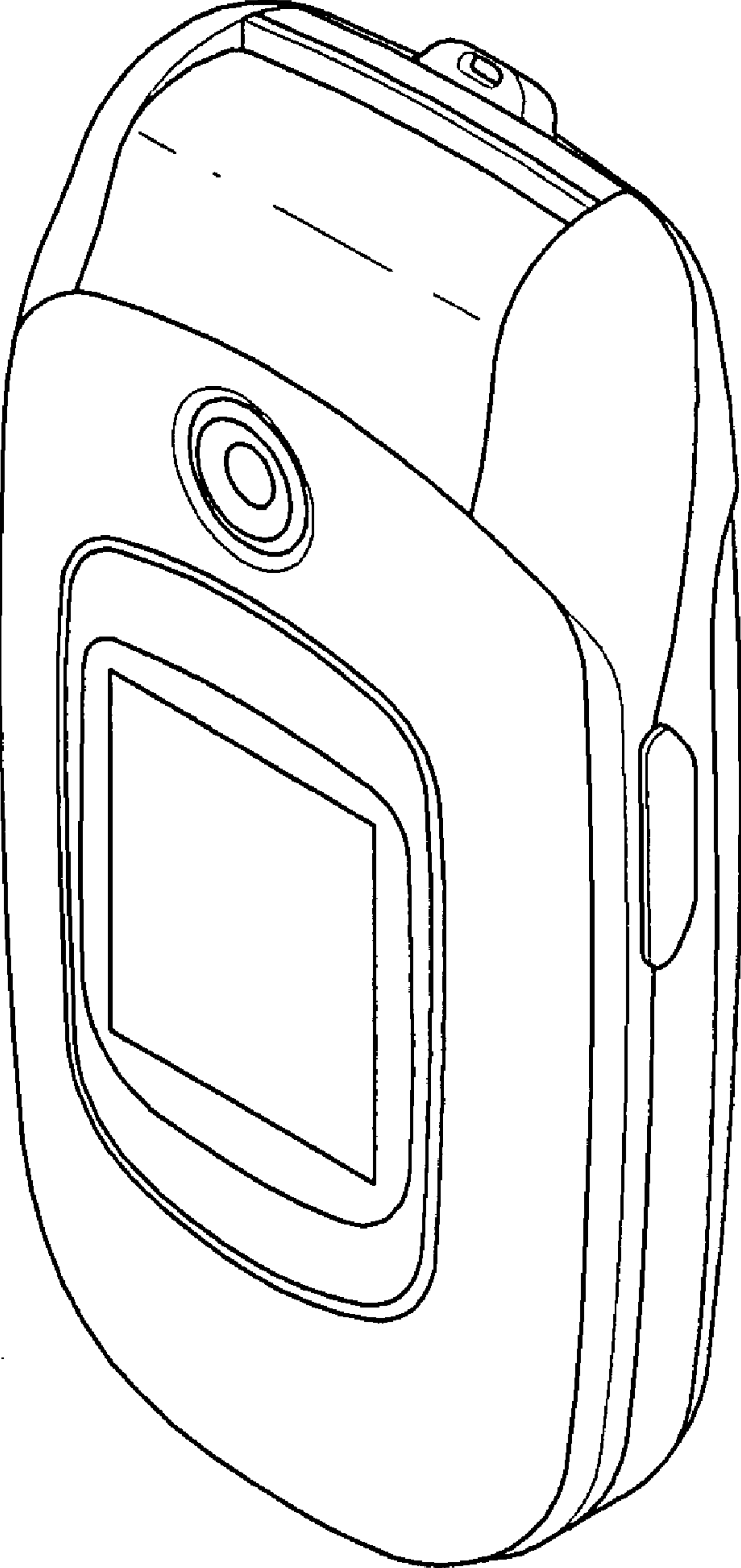

FIG. 2

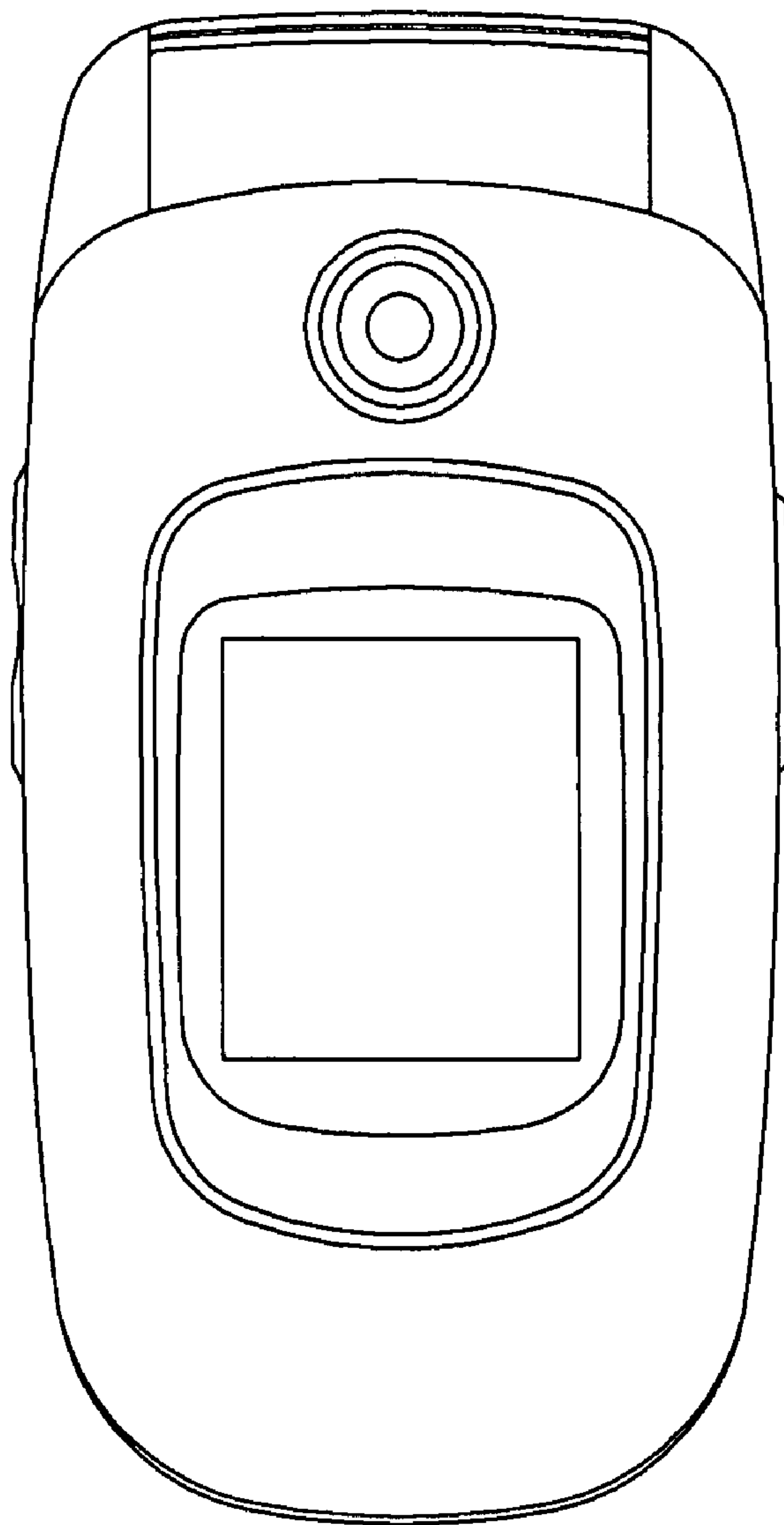

FIG. 3

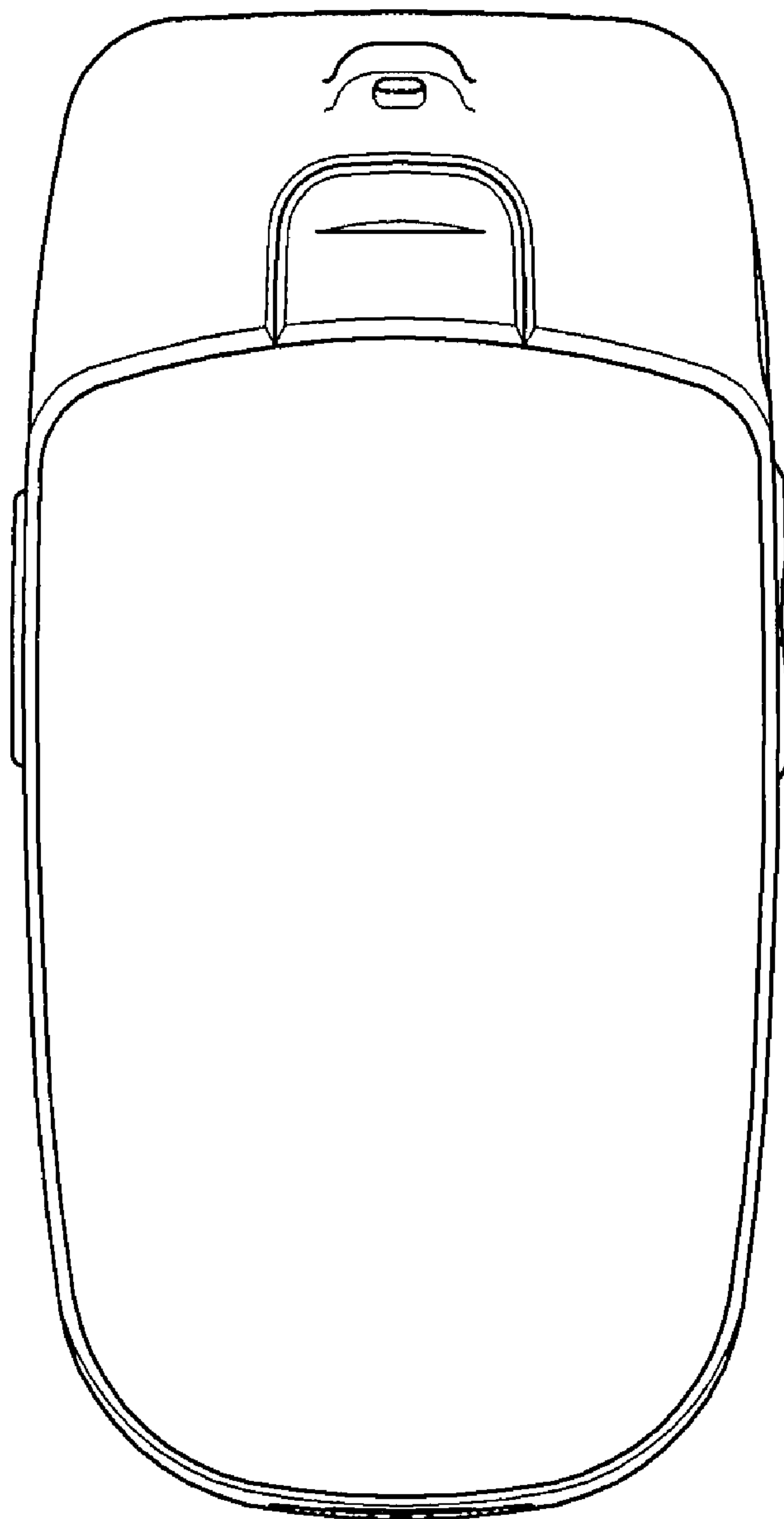

FIG. 4

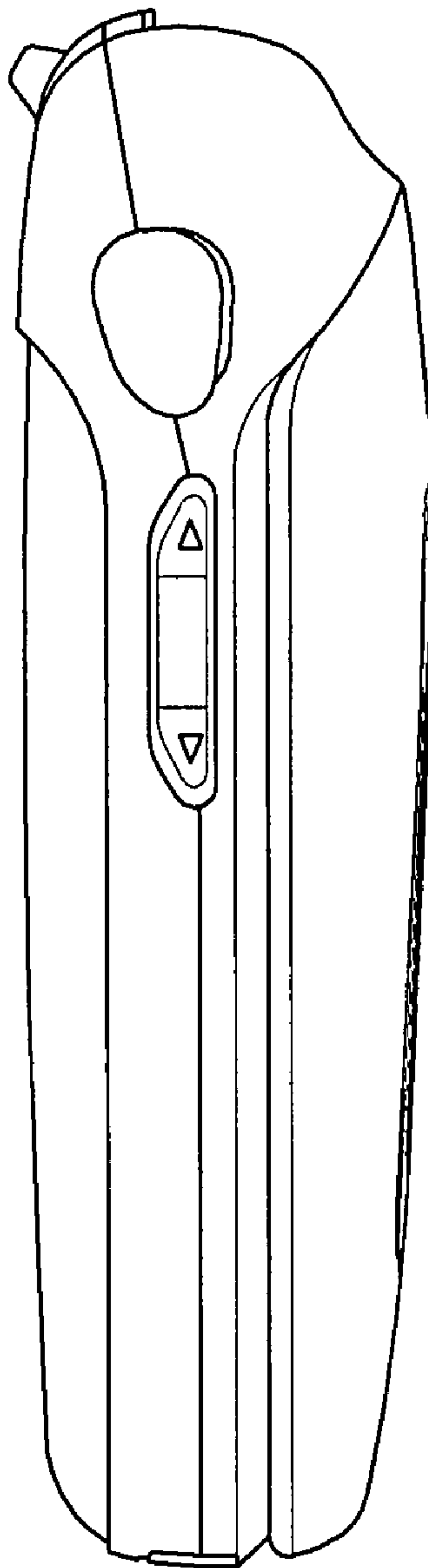

FIG. 5

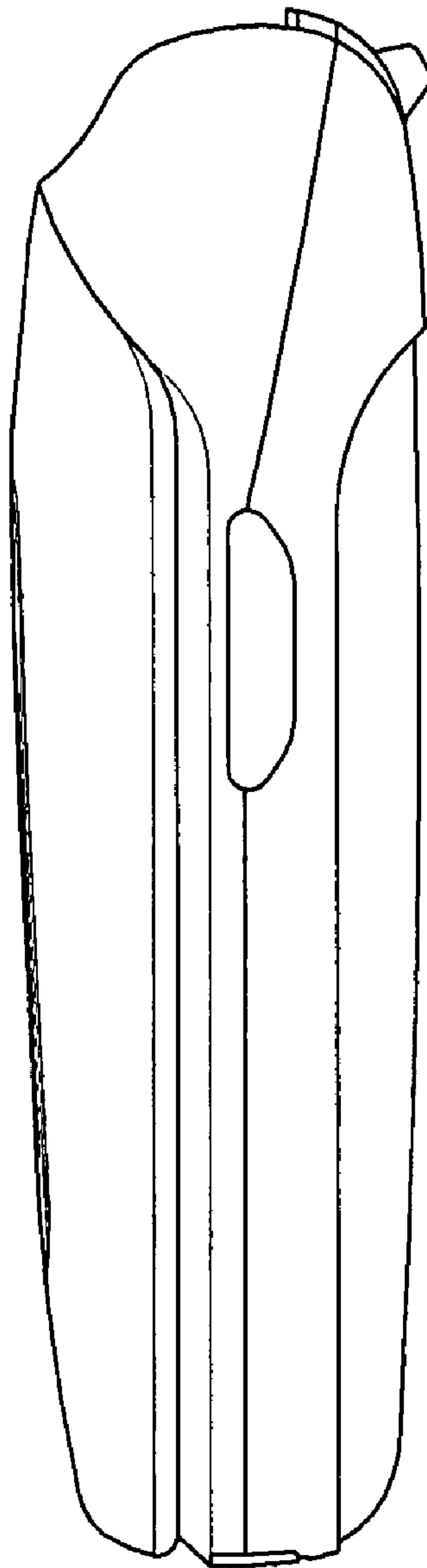

FIG. 6

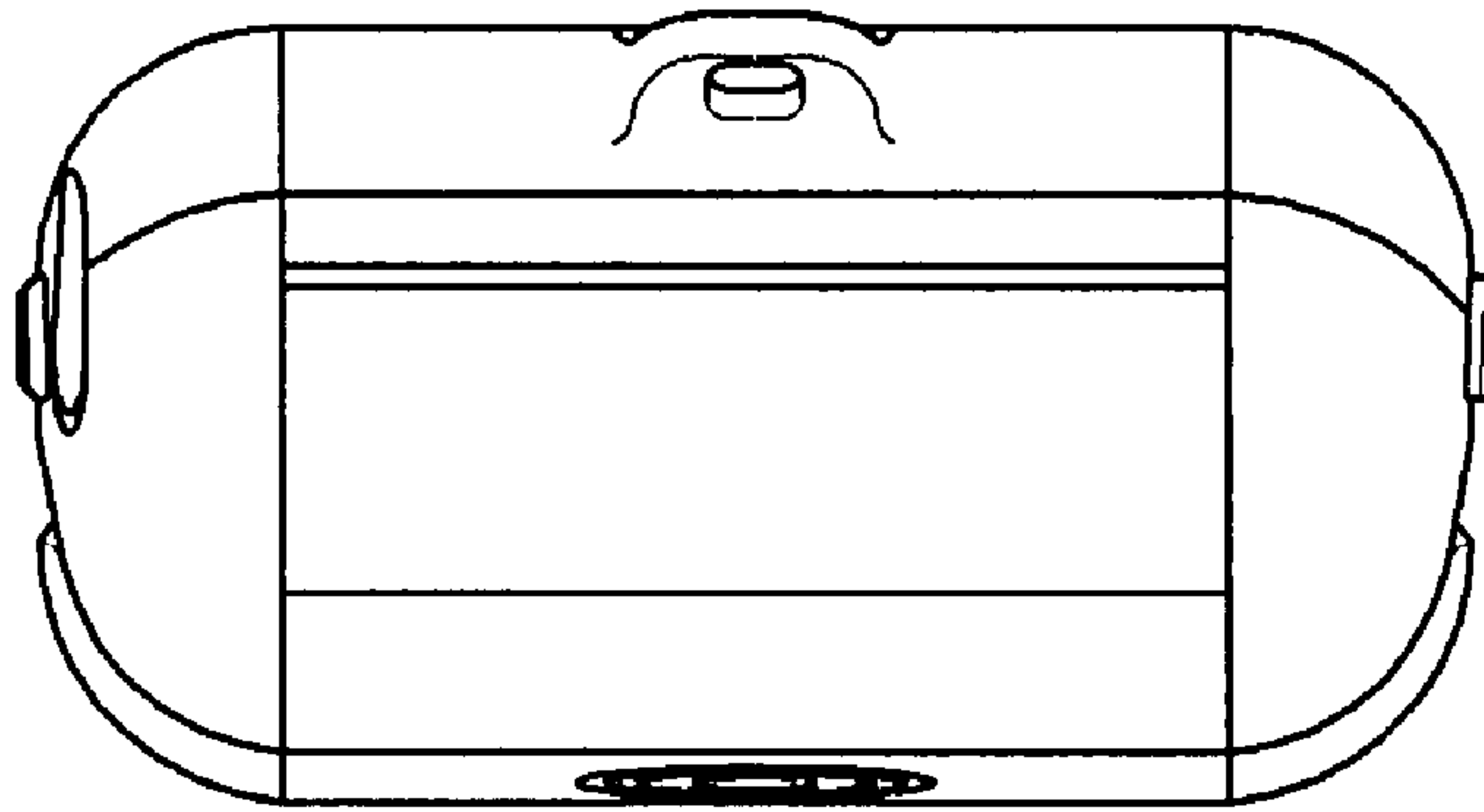

FIG. 7

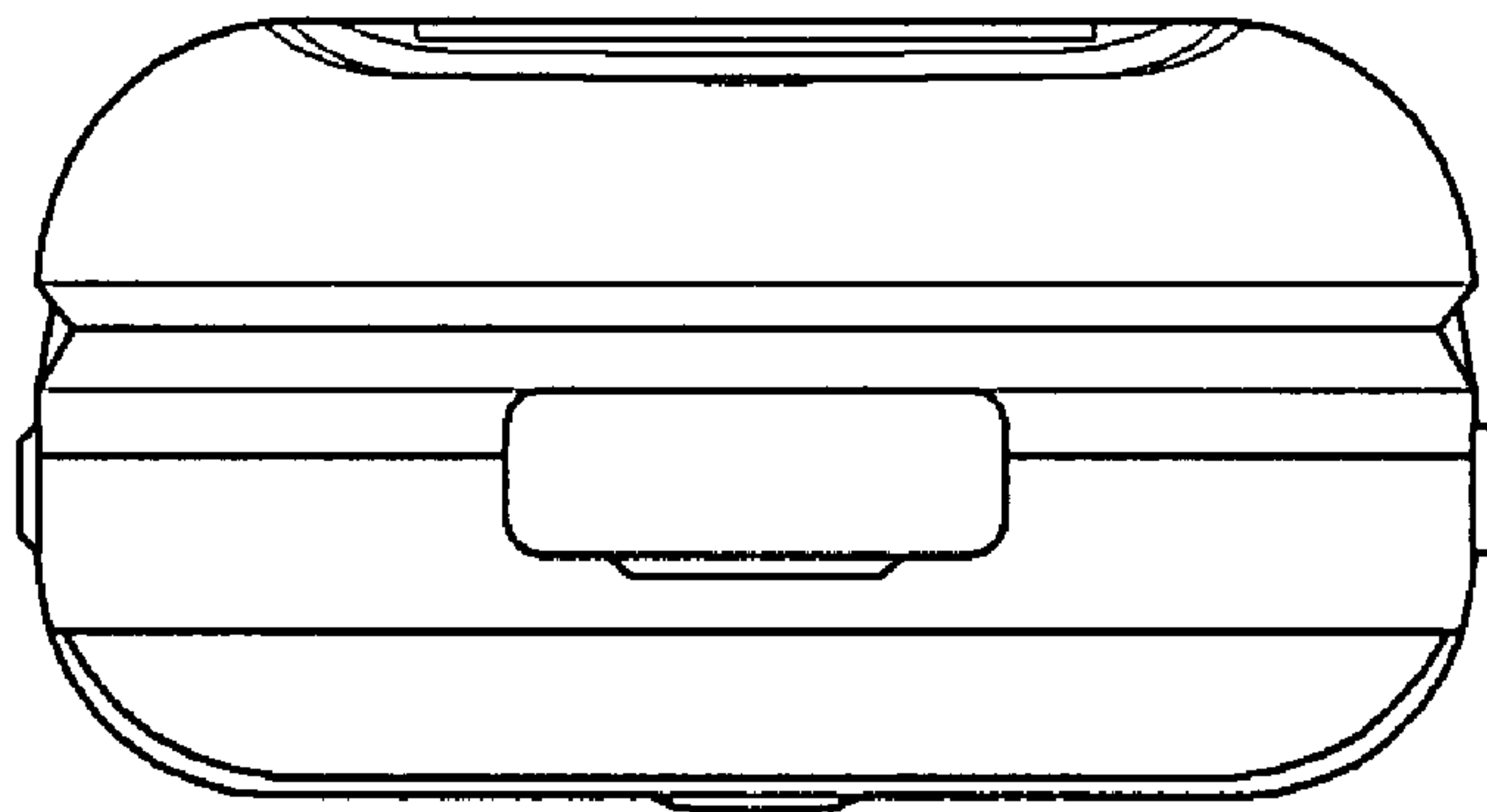

FIG. 8

