

US00D552528S

(12) **United States Design Patent**
Ruat

(10) **Patent No.:** **US D552,528 S**

(45) **Date of Patent:** **** Oct. 9, 2007**

(54) **DRIVER SIDE WIPER ARM**

D445,754 S * 7/2001 Benoit D12/219
D462,044 S * 8/2002 Gfatter et al. D12/219
D512,362 S * 12/2005 Breesch et al. D12/219

(75) Inventor: **Olivier Ruat**, St. Babel (FR)

(73) Assignee: **Valeo Systemes d'Essuyage** (FR)

* cited by examiner

(**) Term: **14 Years**

Primary Examiner—Stacia Cadmus
(74) *Attorney, Agent, or Firm*—Sofer & Haroun, LLP

(21) Appl. No.: **29/255,592**

(22) Filed: **Mar. 8, 2006**

(57) **CLAIM**

(30) **Foreign Application Priority Data**

I claim the ornamental design for a driver side wiper arm, as shown.

Sep. 9, 2005 (FR) 05 4371

DESCRIPTION

(51) **LOC (8) Cl.** **12-06**

(52) **U.S. Cl.** **D12/219**

(58) **Field of Classification Search** D12/219–220;
15/250.31–250.33, 250.351, 250.38, 250.4,
15/250.41–44, 250.201, 250.451–250.458,
15/250.48, 250.04, 250.07, 250.44

FIG. 1 is a right side view of the driver side wiper arm showing the new design;

FIG. 2 is a left side view of the driver side wiper arm as shown in FIG. 1, in accordance with the present invention;

FIG. 3 is a top view of the driver side wiper arm as shown in FIG. 1, in accordance with the present invention;

FIG. 4 is a bottom view of the driver side wiper arm as shown in FIG. 1, in accordance with the present invention;

FIG. 5 is a front view of the driver side wiper arm as shown in FIG. 1, in accordance with the present invention;

FIG. 6 is a back side view of the driver side wiper arm as shown in FIG. 1, in accordance with the present invention; and,

FIG. 7 is a perspective view of the driver side wiper arm as shown in FIG. 1, in accordance with the present invention.

See application file for complete search history.

(56) **References Cited**

U.S. PATENT DOCUMENTS

D152,340 S * 1/1949 Krohm D12/220
D178,840 S * 9/1956 Krohm D12/220
D297,224 S * 8/1988 Kock D12/220
D345,537 S * 3/1994 Bianco et al. D12/220
D345,538 S * 3/1994 Bianco et al. D12/220
D430,097 S * 8/2000 Breesch et al. D12/219
D431,223 S * 9/2000 Breesch et al. D12/219
D431,520 S * 10/2000 Breesch et al. D12/219
D432,072 S * 10/2000 Breesch et al. D12/219

1 Claim, 7 Drawing Sheets

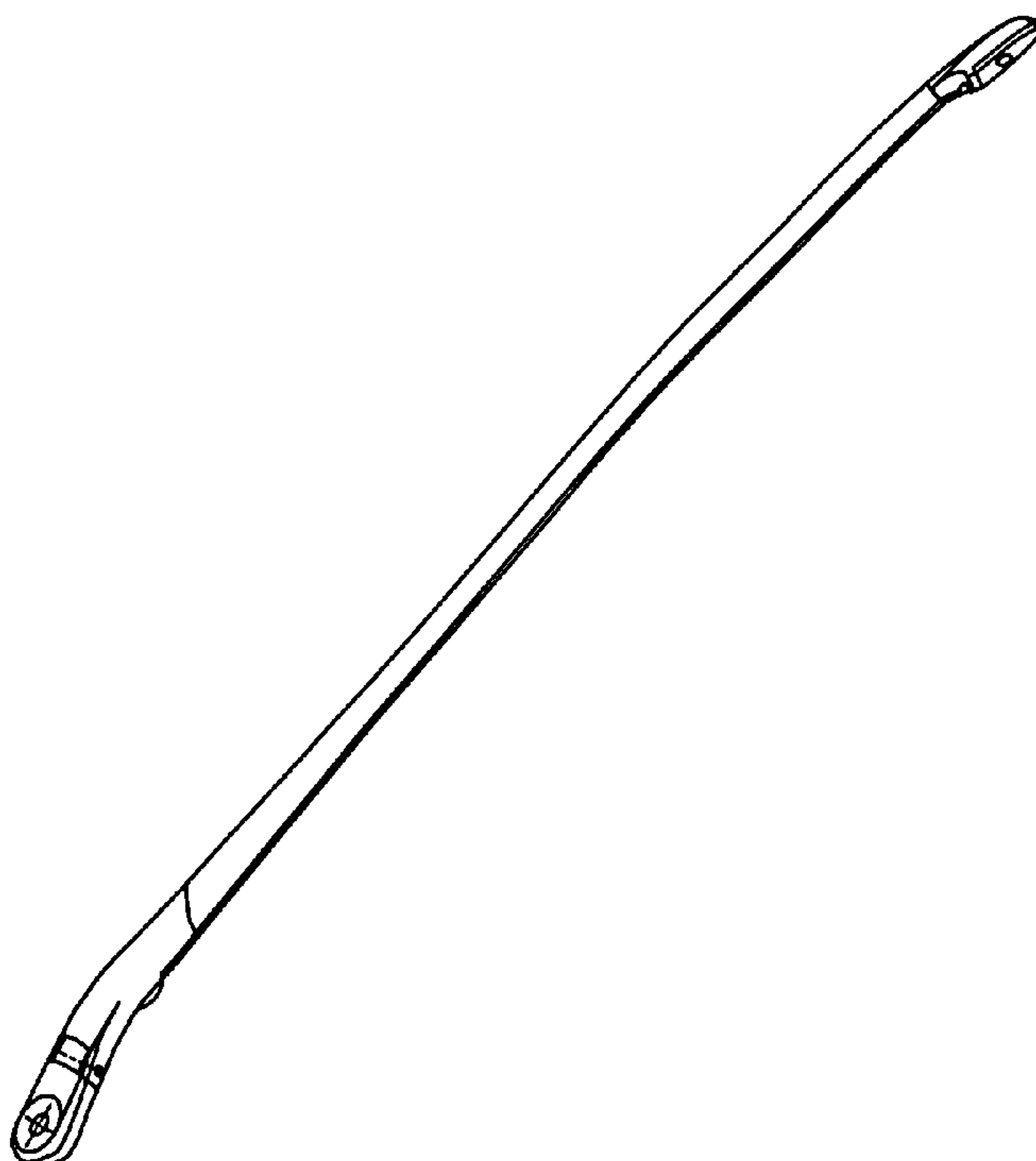

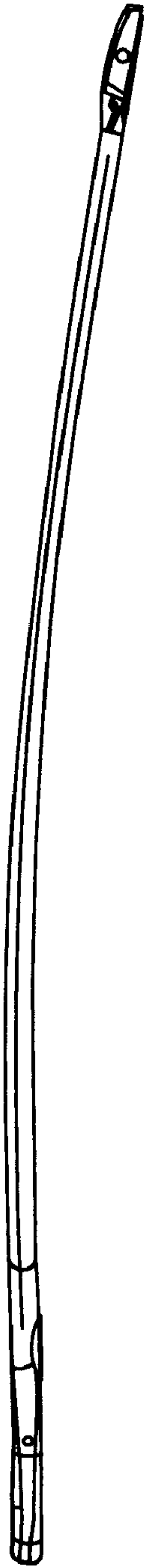

FIG. 1

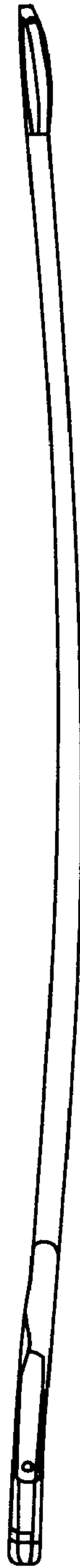

FIG. 2

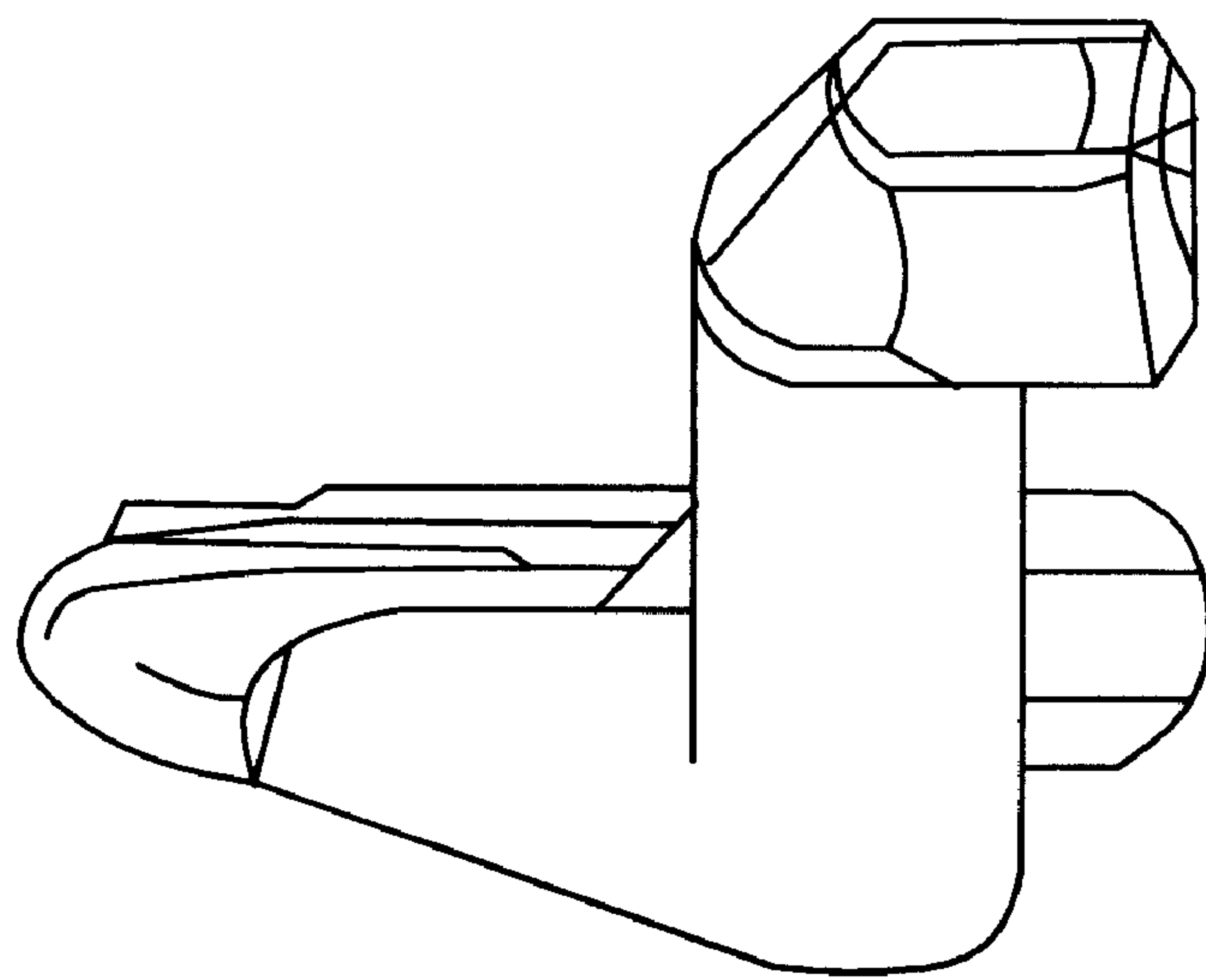

FIG. 3

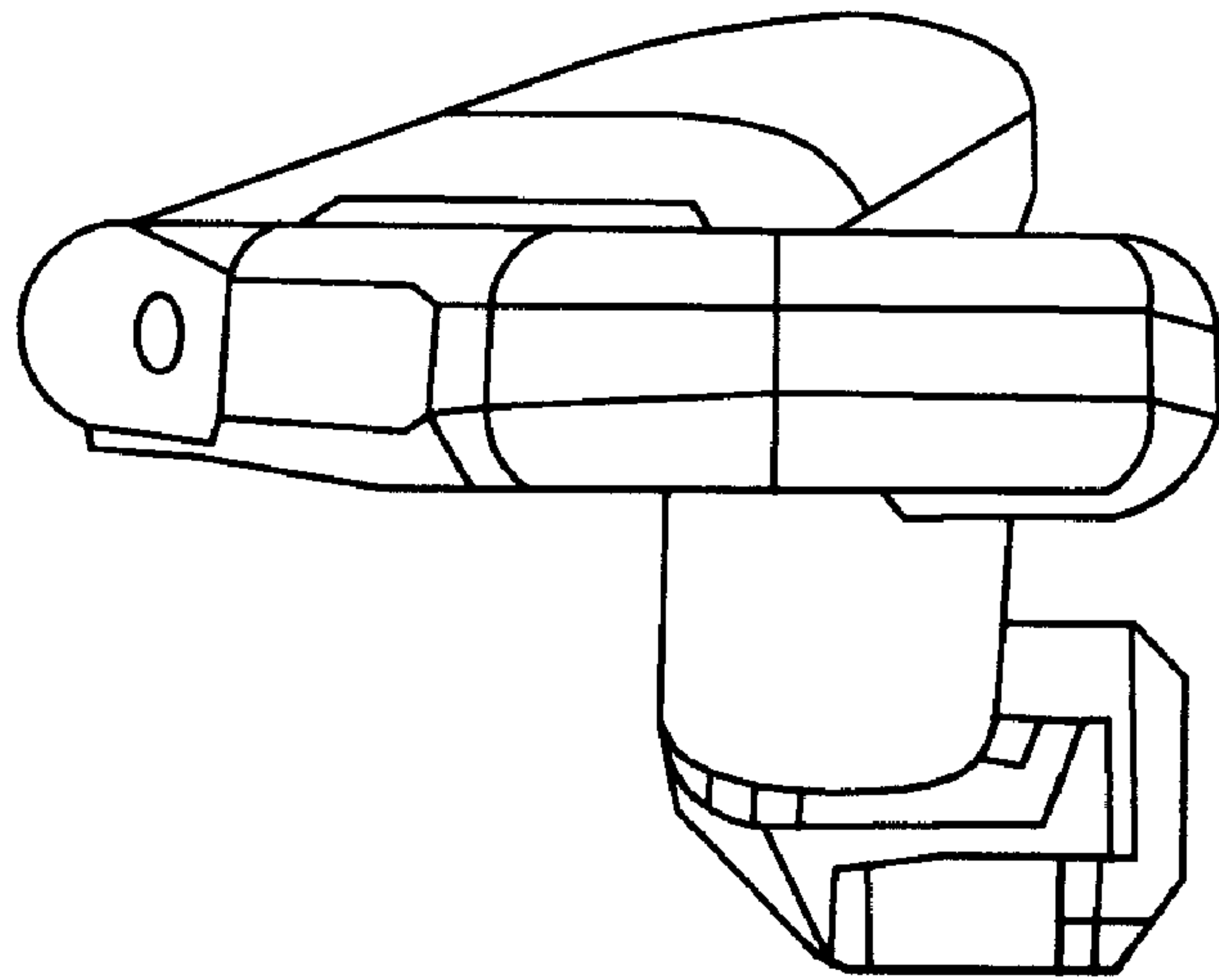

FIG. 4

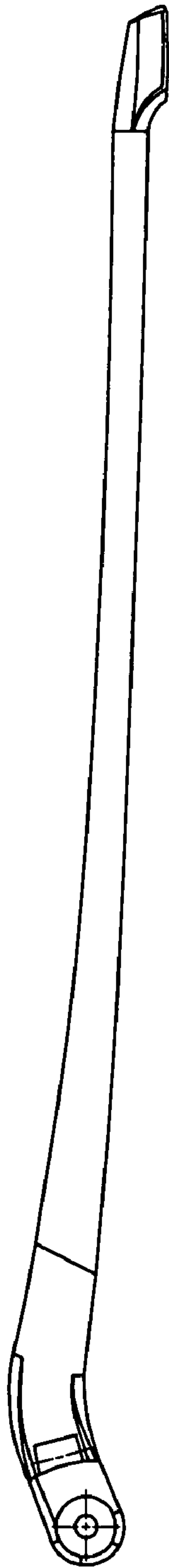

FIG. 5

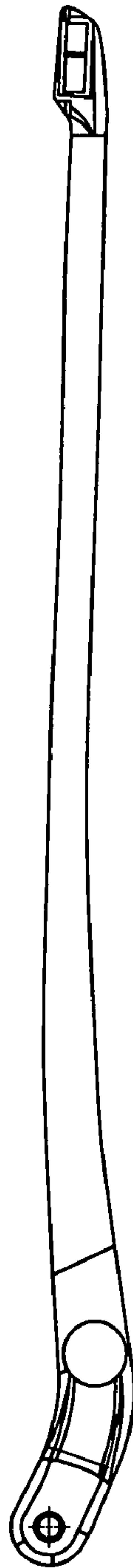

FIG. 6

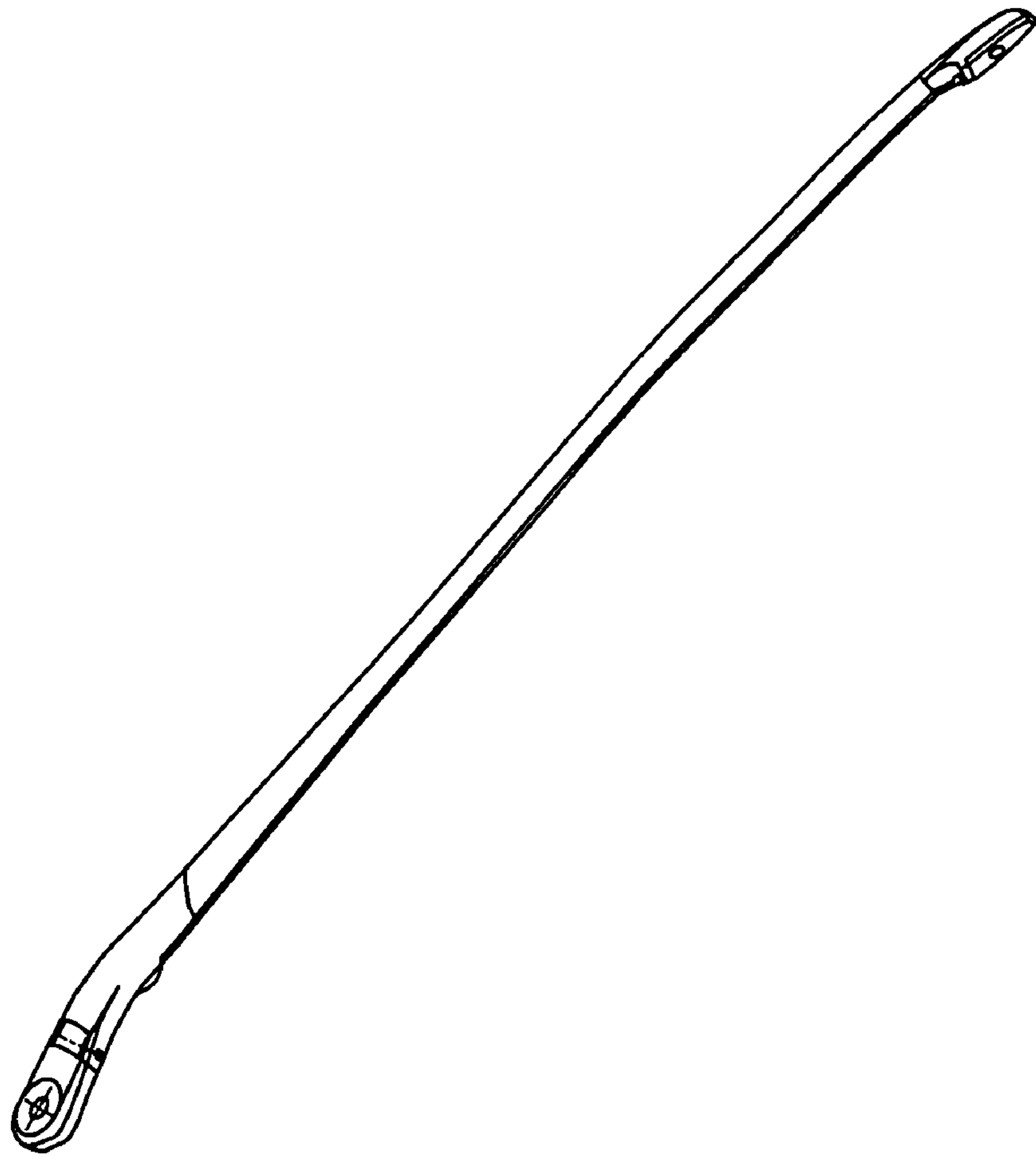

FIG. 7