

US00D552462S

(12) **United States Design Patent**
Boyd et al.

(10) **Patent No.:** **US D552,462 S**

(45) **Date of Patent:** **** Oct. 9, 2007**

(54) **CLIP**

(75) Inventors: **Michael Boyd**, Boulder, CO (US);
Bowden Ormsbee, Longmont, CO (US)

(73) Assignee: **Nite Ize, Inc.**, Boulder, CO (US)

(**) Term: **14 Years**

(21) Appl. No.: **29/285,038**

(22) Filed: **Mar. 19, 2007**

(51) **LOC (8) Cl.** **08-08**

(52) **U.S. Cl.** **D8/395**

(58) **Field of Classification Search** D8/356,
D8/371, 394-396; D19/65, 56; 24/22, 67 R,
24/20 S, 115 R, 546, 563, 910, 343, 67.9;
248/74.2, 215, 227.1, 49, 300, 301, 316.7,
248/51, 489

See application file for complete search history.

(56) **References Cited**

U.S. PATENT DOCUMENTS

- 881,757 A * 3/1908 Winsor 24/10 A
- D154,930 S * 8/1949 Kikuchi D8/371
- 2,659,378 A * 11/1953 Caserta 132/276
- D220,424 S * 4/1971 Hindenburg D8/395

- D251,124 S * 2/1979 Takeuchi D19/65
- D265,381 S * 7/1982 Borja D8/395
- D280,973 S * 10/1985 Ferrell D8/395

* cited by examiner

Primary Examiner—Stella M. Reid

Assistant Examiner—John Windmuller

(74) *Attorney, Agent, or Firm*—Patton Boggs LLP

(57) **CLAIM**

The ornamental design for clip, as shown and described.

DESCRIPTION

FIG. 1 is a front perspective view of a clip showing our new design;

FIG. 2 is a rear perspective view thereof;

FIG. 3 is a front elevational view thereof;

FIG. 4 is a rear elevational view thereof;

FIG. 5 is a right side elevational view thereof;

FIG. 6 is a left side elevational view thereof;

FIG. 7 is a top plan view thereof; and,

FIG. 8 is a bottom plan view thereof.

1 Claim, 3 Drawing Sheets

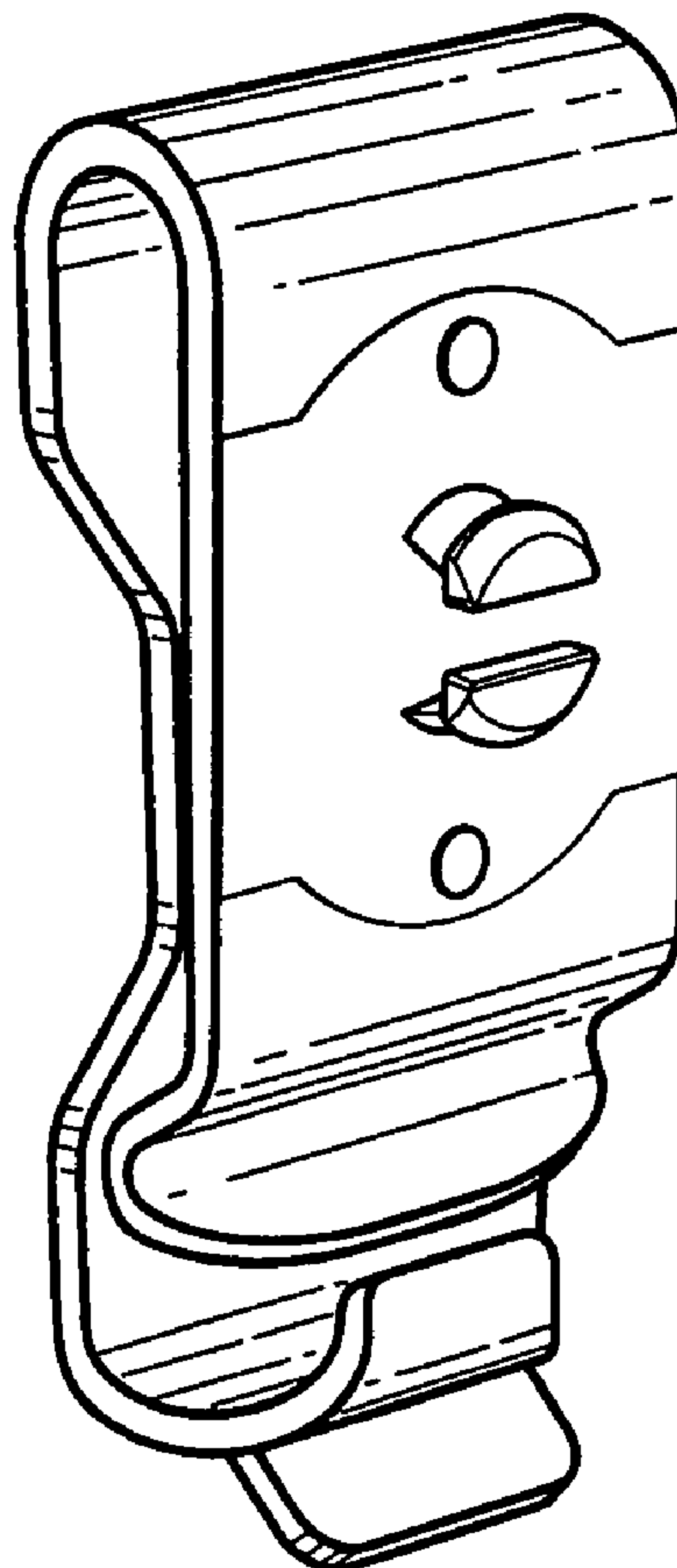
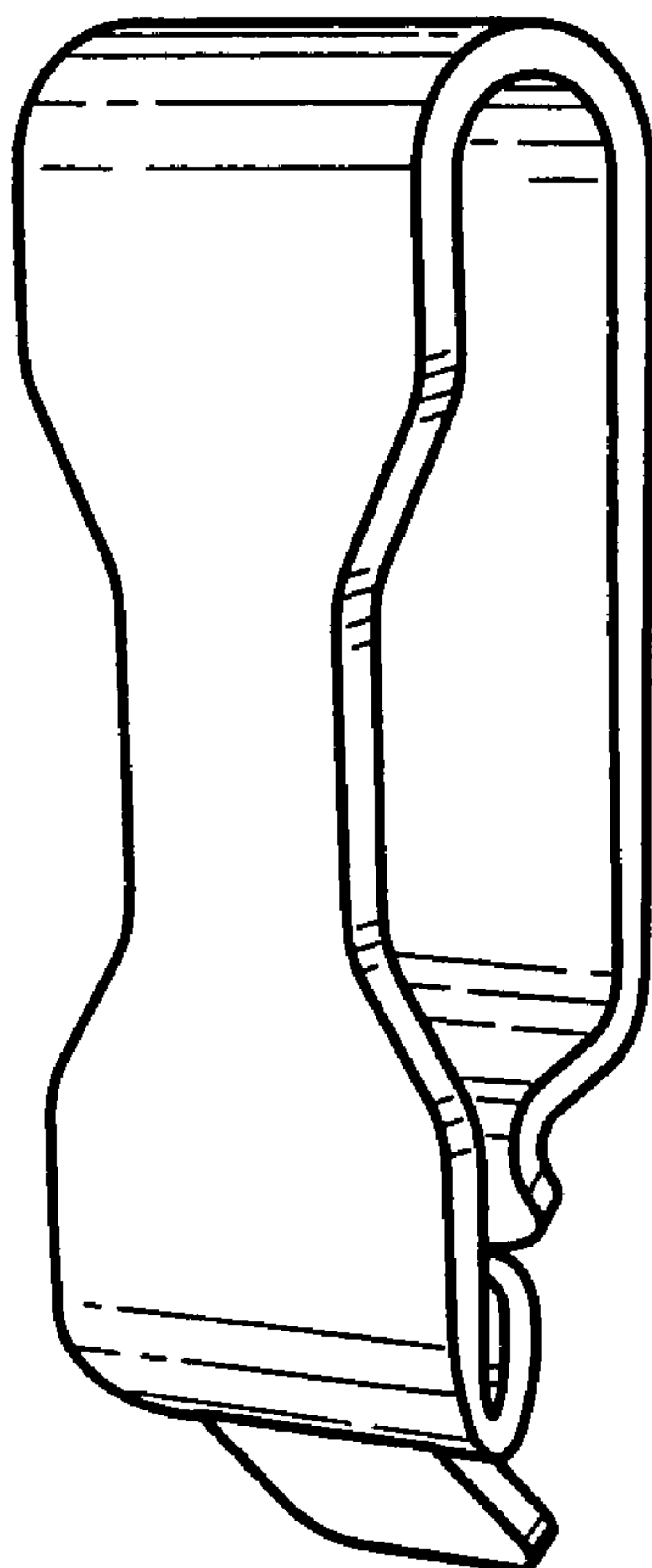

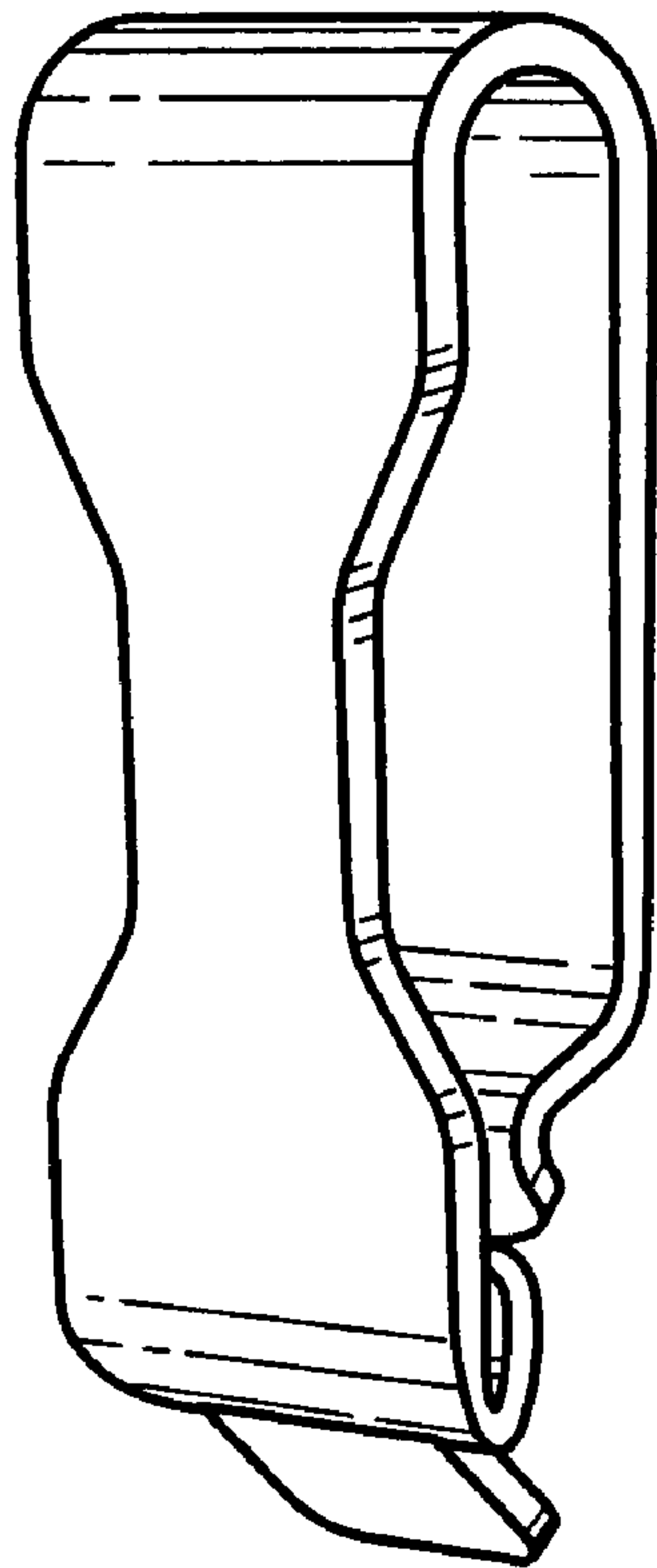

FIG. 1

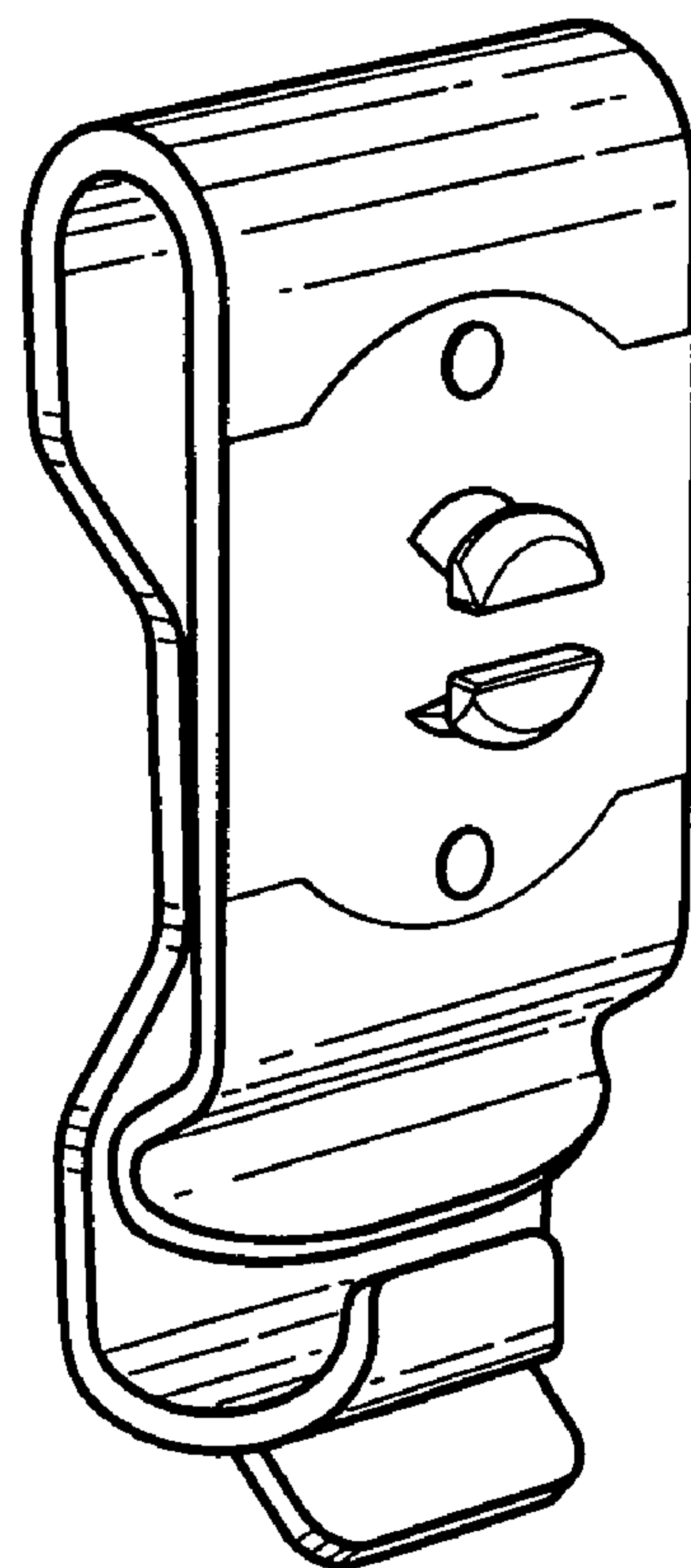

FIG. 2

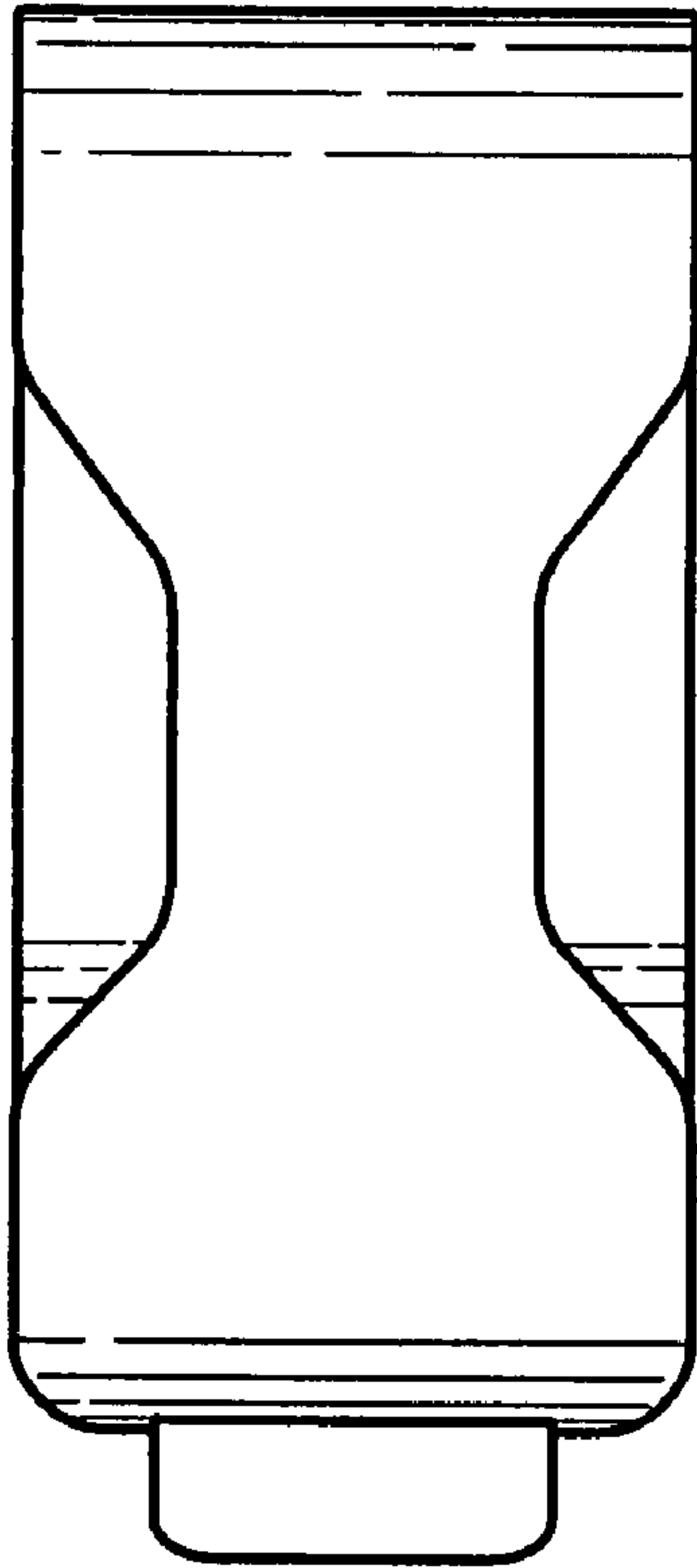

FIG. 3

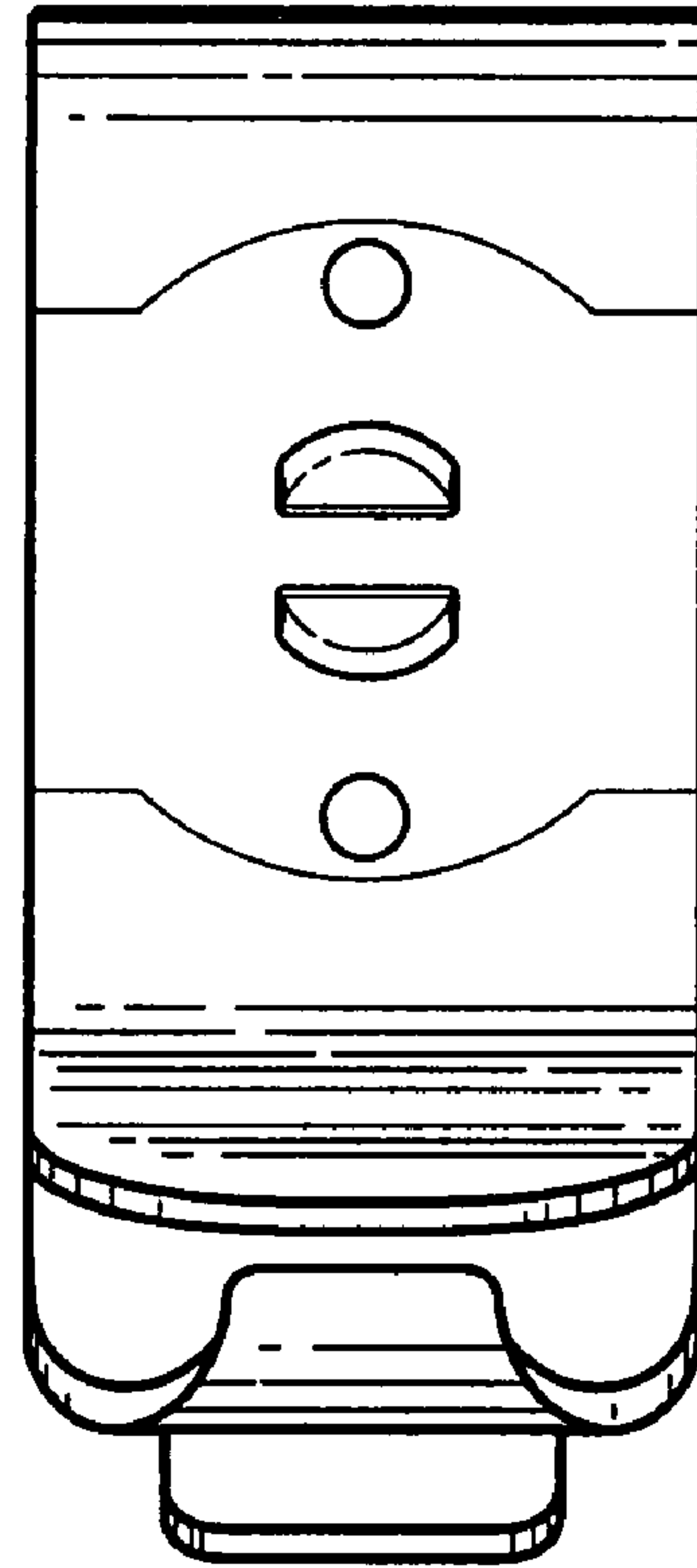

FIG. 4

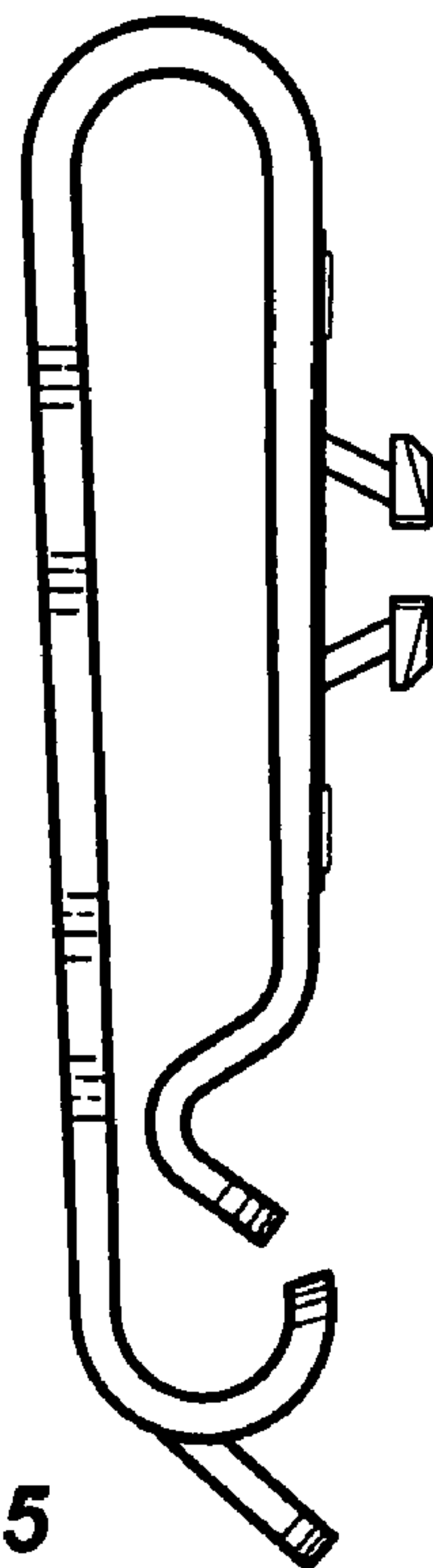

FIG. 5

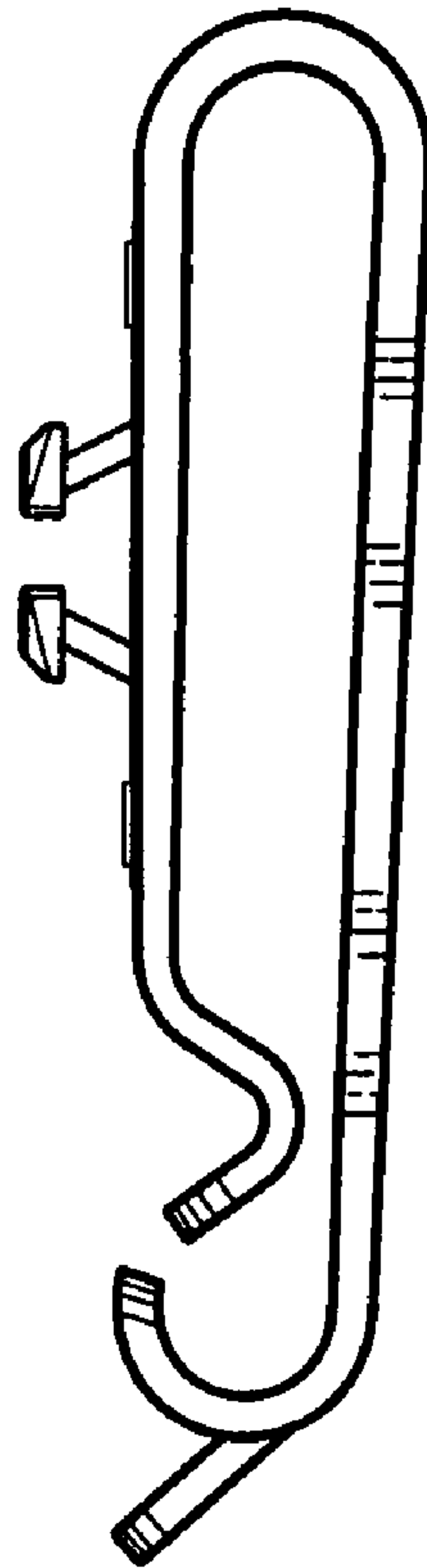

FIG. 6

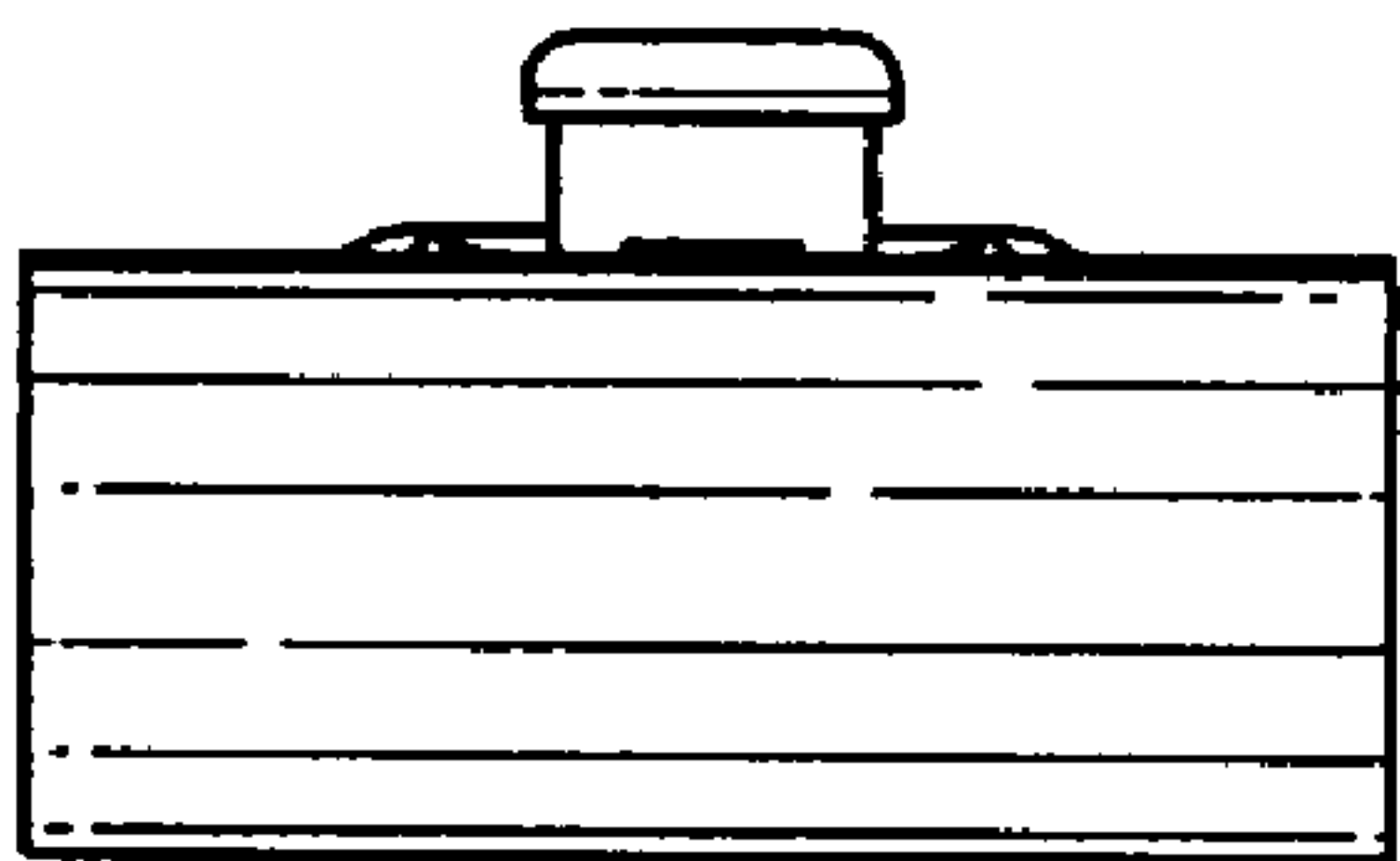

FIG. 7

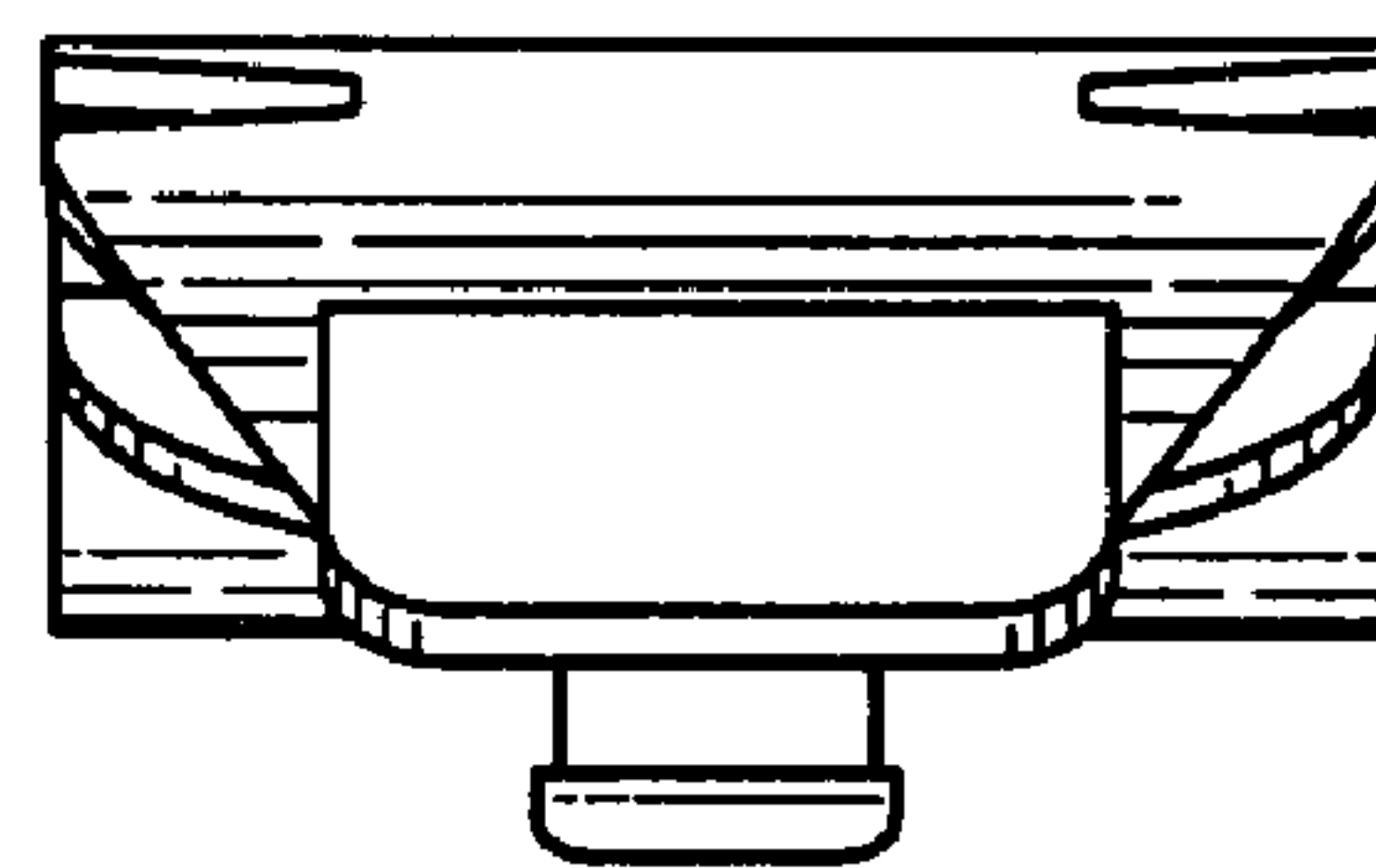

FIG. 8