



US00D552435S

(12) **United States Design Patent**  
**Bohlman et al.**

(10) **Patent No.:** **US D552,435 S**

(45) **Date of Patent:** **\*\* Oct. 9, 2007**

(54) **GARDEN SHEAR AND STRIPPING DEVICE**

(76) Inventors: **Barbara E. Bohlman**, 15234-1/4  
Dickens St., Sherman Oaks, CA (US)  
91403; **Camille B. Carr**, 15234-1/4  
Dickens St., Sherman Oaks, CA (US)  
91403

(\*\*) Term: **14 Years**

(21) Appl. No.: **29/247,718**

(22) Filed: **Jul. 6, 2006**

(51) **LOC (8) Cl.** ..... **08-01**

(52) **U.S. Cl.** ..... **D8/5**

(58) **Field of Classification Search** ..... D8/4-5,  
D8/57; 30/251, 260, 262  
See application file for complete search history.

(56) **References Cited**

**U.S. PATENT DOCUMENTS**

1,322,085	A	11/1919	Bertrand	
2,086,081	A	7/1937	Hollenbeck	
5,170,559	A	12/1992	Orthey et al.	
D342,657	S *	12/1993	Choi	D8/5
D393,189	S	4/1998	Spear et al.	
D419,043	S *	1/2000	Staton	D8/5
D439,812	S *	4/2001	Staton	D8/5
D458,815	S *	6/2002	Meyerratken	D8/5
D472,433	S	4/2003	Richwine et al.	
D476,199	S	6/2003	Richwine et al.	

6,634,105	B2	10/2003	Lindermeir	
D496,837	S	10/2004	Tomchak et al.	
D501,379	S *	2/2005	Lipscomb et al.	D8/5
D503,595	S *	4/2005	Lipscomb et al.	D8/5
2005/0198832	A1	9/2005	Hsien	

\* cited by examiner

*Primary Examiner*—Holly H. Baynham

*Assistant Examiner*—Sheryl Friedman

(74) *Attorney, Agent, or Firm*—Kelly Lowry & Kelley, LLP

(57) **CLAIM**

The ornamental design for a garden shear and stripping device, as shown and described.

**DESCRIPTION**

FIG. 1 is a side perspective view of the device, showing blades thereof in a closed position;

FIG. 2 is a side perspective view of the device, illustrating the blades thereof in an open position;

FIG. 3 is a front end view of the device;

FIG. 4 is a rear end view of the device;

FIG. 5 is a top plan view of the device;

FIG. 6 is a bottom plan view of the device;

FIG. 7 is a side elevational view of the device; and,

FIG. 8 is a side elevational view of the device taken from the opposite side of the device as FIG. 7.

**1 Claim, 3 Drawing Sheets**

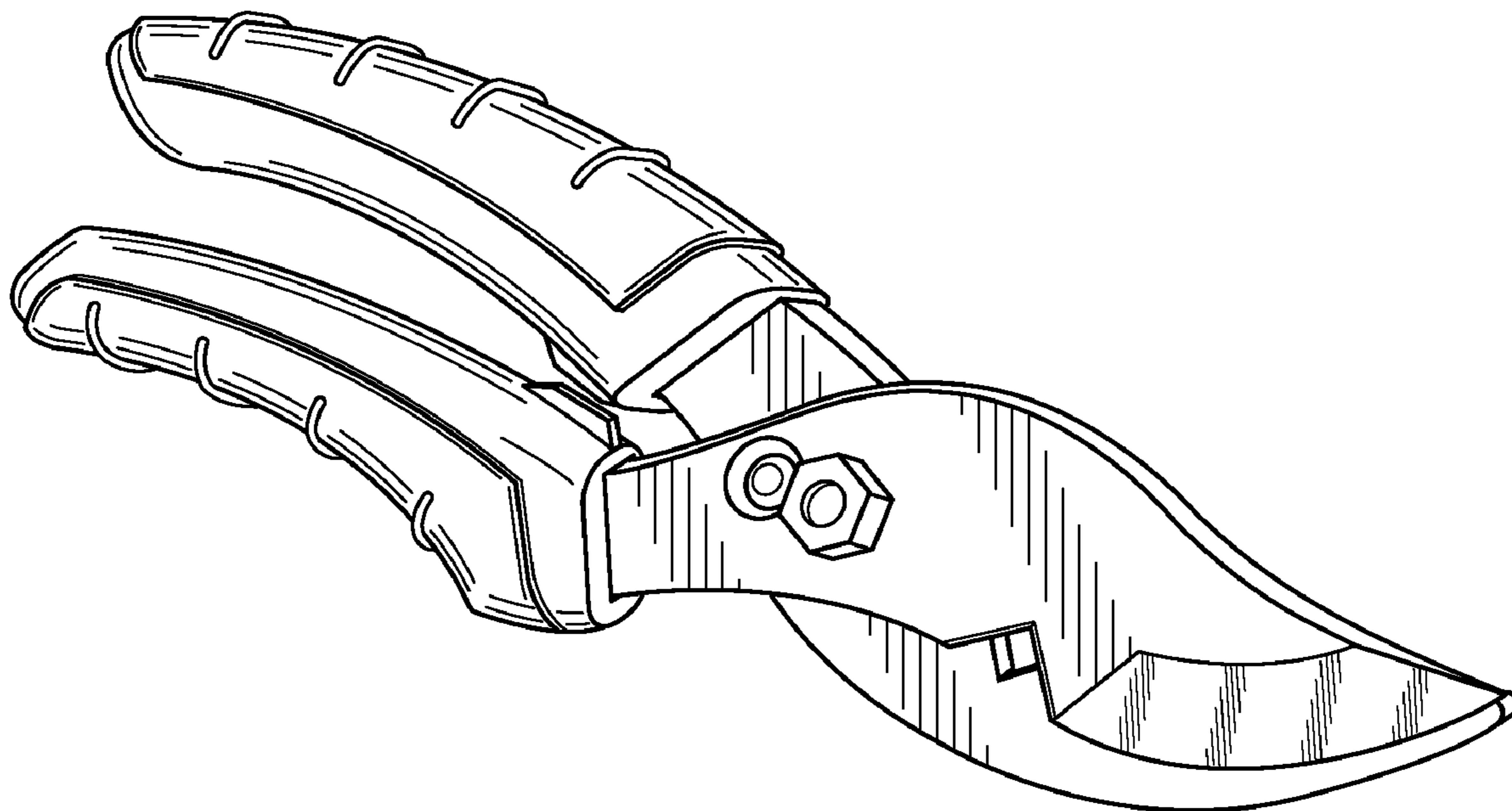

FIG. 1

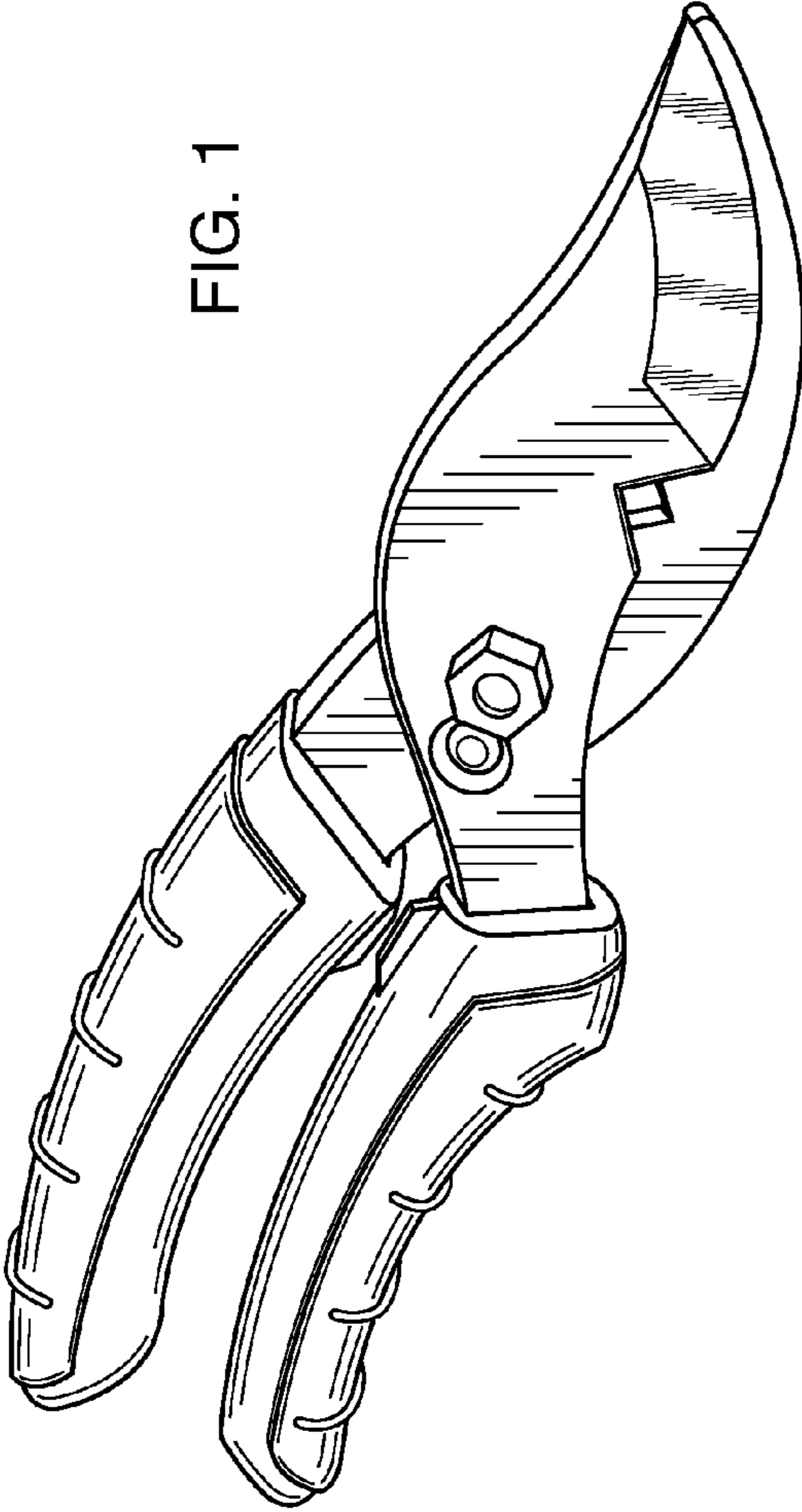
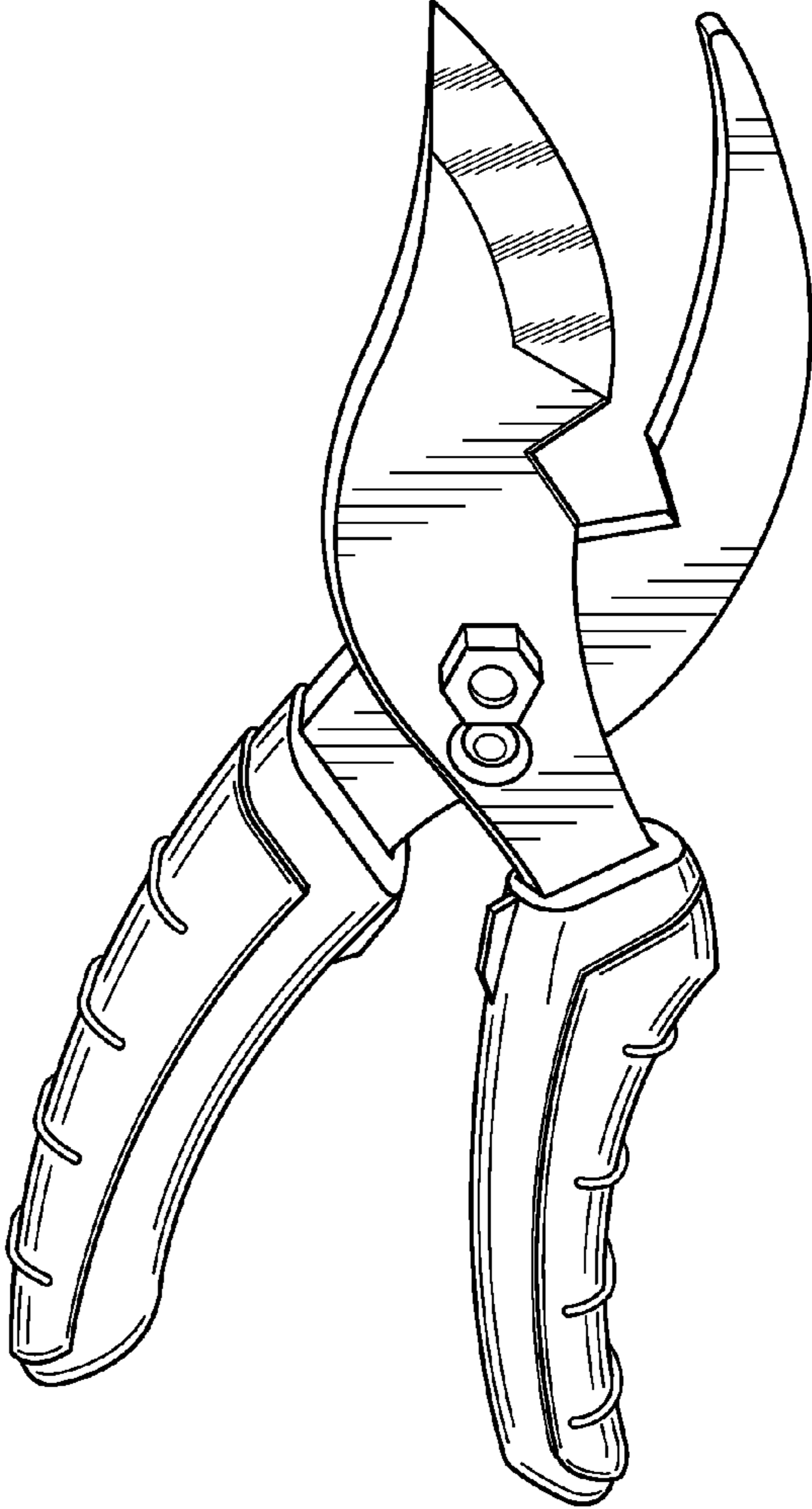

FIG. 2



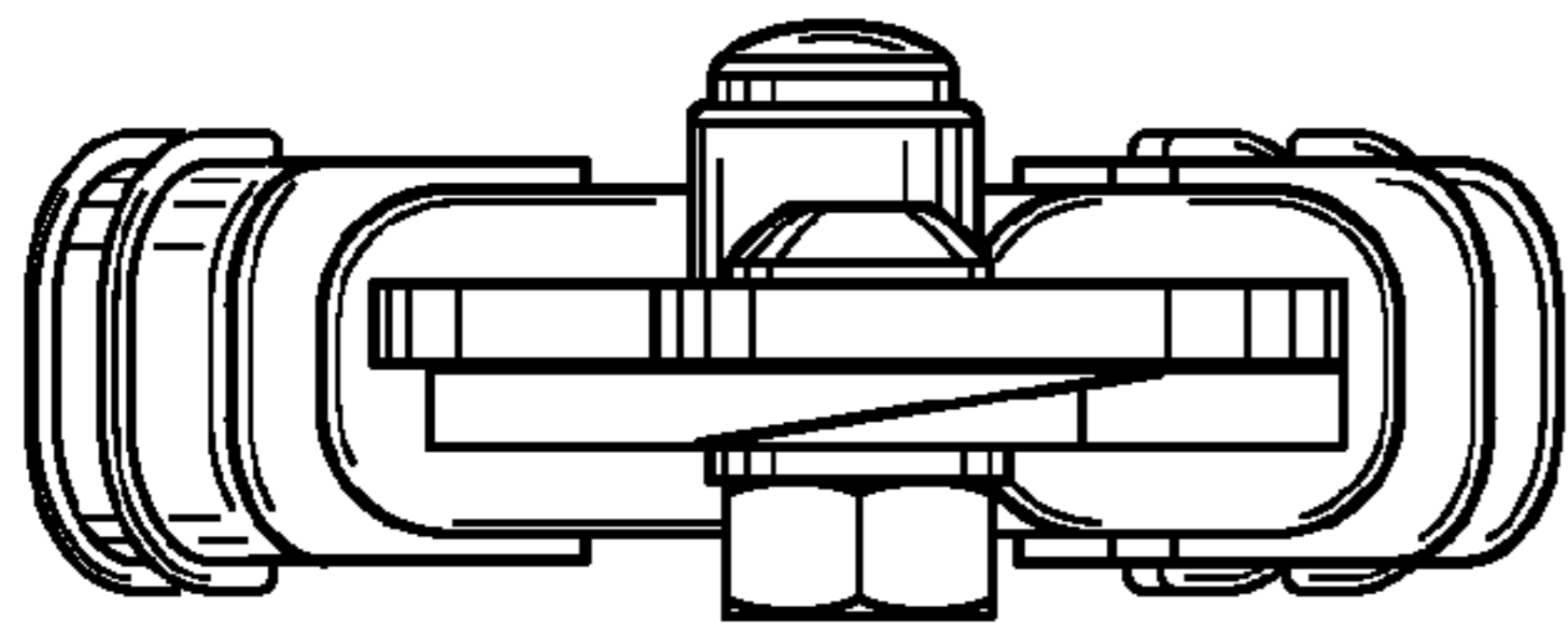

FIG. 3

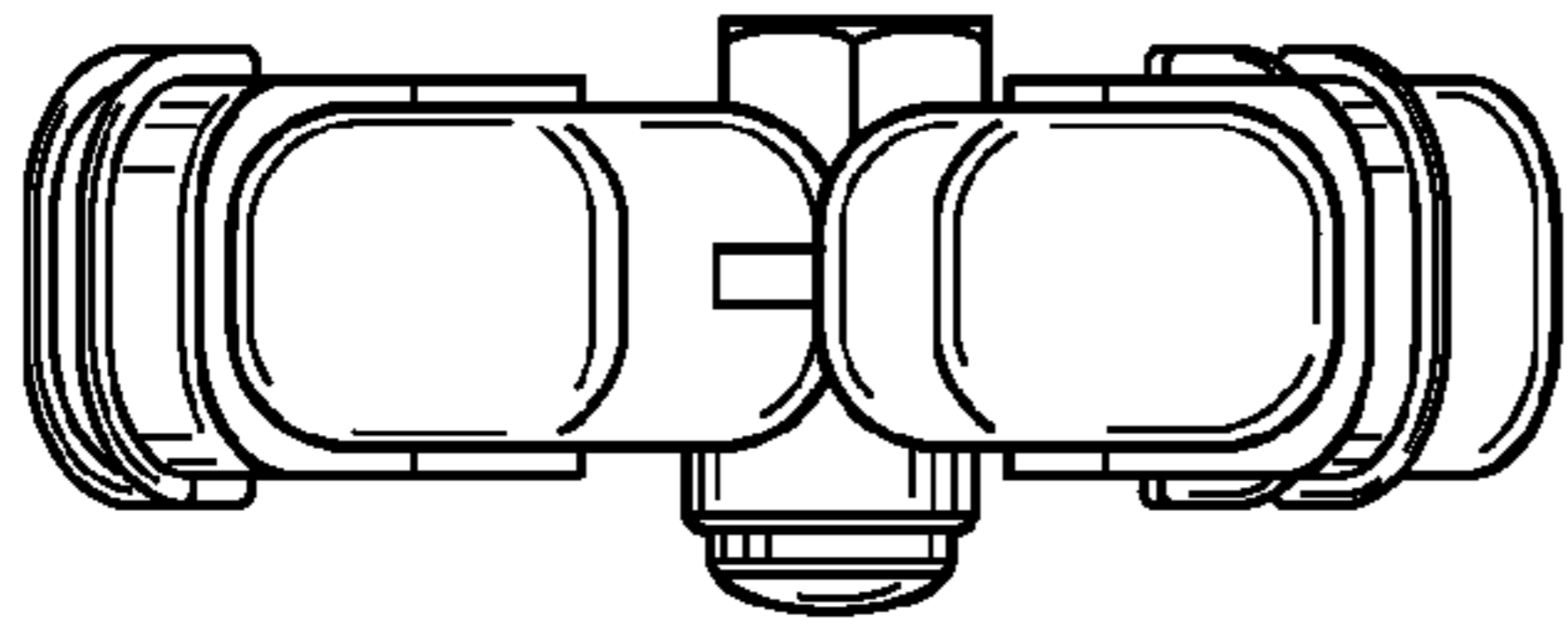

FIG. 4

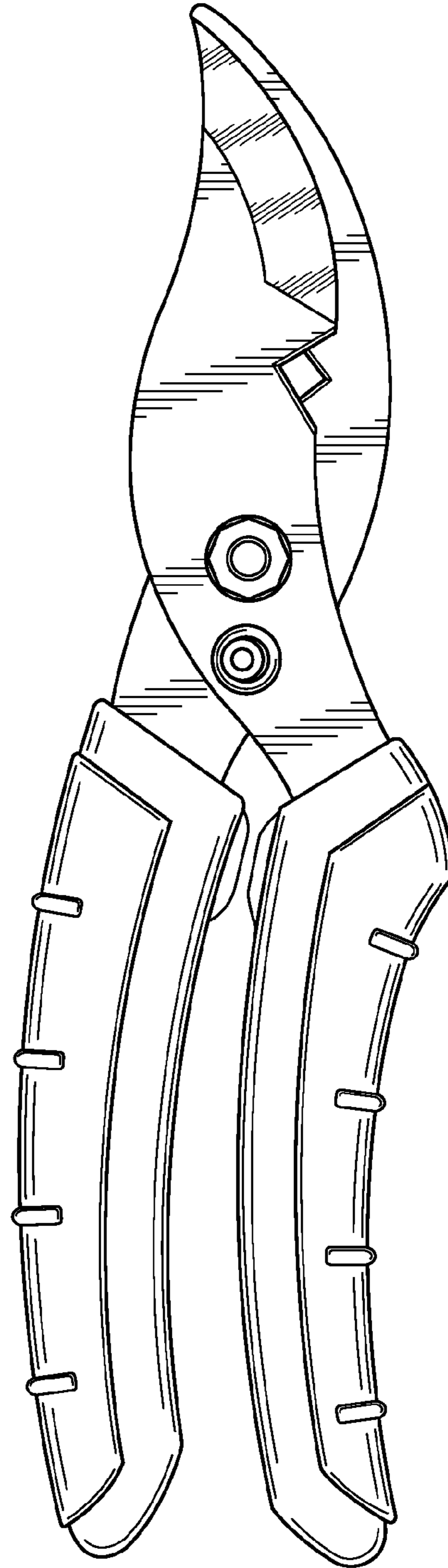

FIG. 5

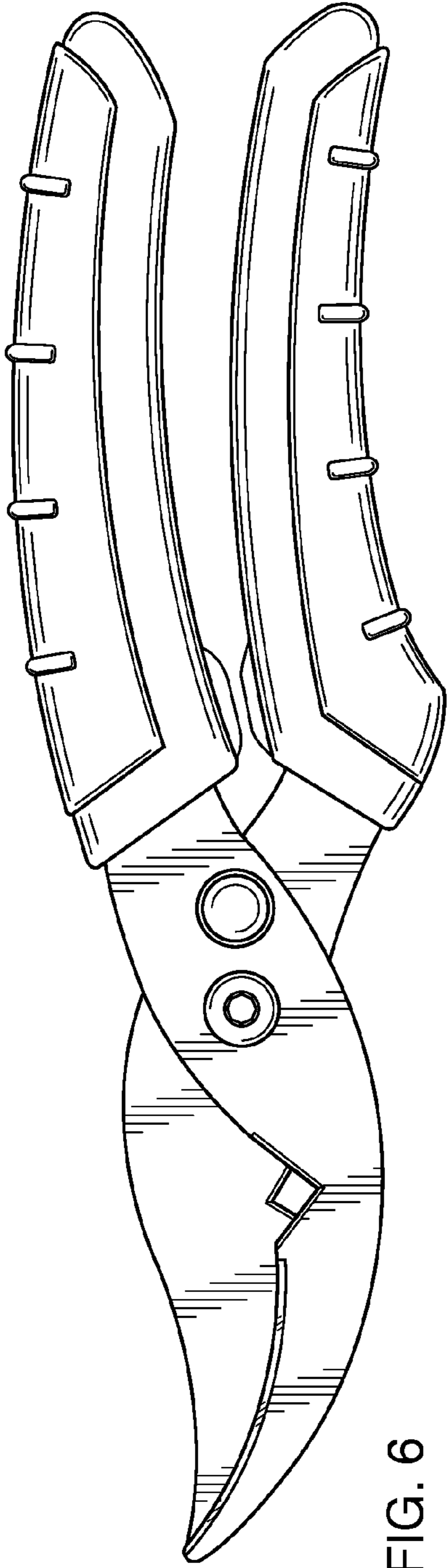

FIG. 6

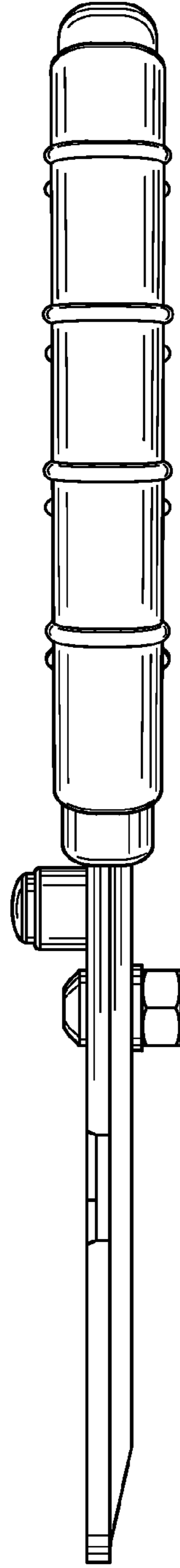

FIG. 7

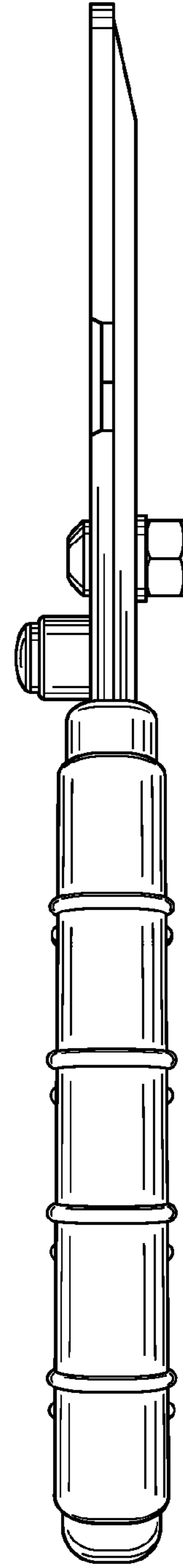

FIG. 8