

US00D552324S

(12) **United States Design Patent** (10) **Patent No.:** **US D552,324 S**
Perrier et al. (45) **Date of Patent:** **** Oct. 2, 2007**

(54) **CART HANDLE**

4,373,133 A 2/1983 Clyne et al.
4,500,880 A 2/1985 Gomersall et al.

(75) Inventors: **R. Sylvain Perrier**, Ottawa (CA);
Jeremy List, Ottawa (CA); **Cliff Read**,
Carp (CA); **Jason Busschaert**, Towson,
MD (US); **Mark Edey**, Ottawa (CA);
James D. Miller, Holland Landing
(CA); **Howard W. Overland**, Aurora
(CA)

(Continued)

FOREIGN PATENT DOCUMENTS

GB 2307575 A * 5/1997

(Continued)

OTHER PUBLICATIONS

Interactive Store Guide and Item Locator for Deli Kiosk, www.dumac.com, Jan. 9, 2002.

(Continued)

(73) Assignee: **Springboard Retail Networks
Licensing SRL (BB)**

(**) Term: **14 Years**

(21) Appl. No.: **29/269,319**

(22) Filed: **Nov. 29, 2006**

Primary Examiner—Freda S. Nunn
Assistant Examiner—Kevin K. Rudzinski
(74) *Attorney, Agent, or Firm*—Birch, Stewart, Kolasch &
Birch, LLP

Related U.S. Application Data

(62) Division of application No. 29/241,459, filed on Oct. 28, 2005.

(57) **CLAIM**

The ornamental design for a cart handle, as shown and described.

(30) **Foreign Application Priority Data**

Apr. 29, 2005 (CA) 110968

DESCRIPTION

(51) **LOC (8) Cl.** **12-02**
(52) **U.S. Cl.** **D34/27**
(58) **Field of Classification Search** D34/12-27;
40/308, 506, 611; 280/33.991, 62, 47.17,
280/646, 33.992; D12/133; 403/312; 235/383
See application file for complete search history.

FIG. 1 is a front right perspective view of the cart handle;
FIG. 2 is a rear perspective view of the cart handle of FIG. 1;
FIG. 3 is a front elevation view of the cart handle of FIG. 1;
FIG. 4 is a rear elevation view of the cart handle of FIG. 1;
FIG. 5 is a top plan view of the cart handle of FIG. 1;
FIG. 6 is a bottom plan view of the cart handle of FIG. 1;
FIG. 7 is a left side view of the cart handle of FIG. 1; and,
FIG. 8 is a right side view of the cart handle of FIG. 1.

(56) **References Cited**

U.S. PATENT DOCUMENTS

2,759,281 A 8/1956 Akers, Jr.
3,251,543 A 5/1966 Bush
3,548,524 A * 12/1970 Rohnow 40/506
3,710,108 A 1/1973 Haarhaus et al.
3,836,755 A 9/1974 Ehrat et al.
4,071,740 A 1/1978 Gogulski
4,334,278 A 6/1982 Marmon

The broken line showing of the face, handle ends, front element and bottom surface is included for the purpose of illustrating only and forms no part of the claimed design.

1 Claim, 5 Drawing Sheets

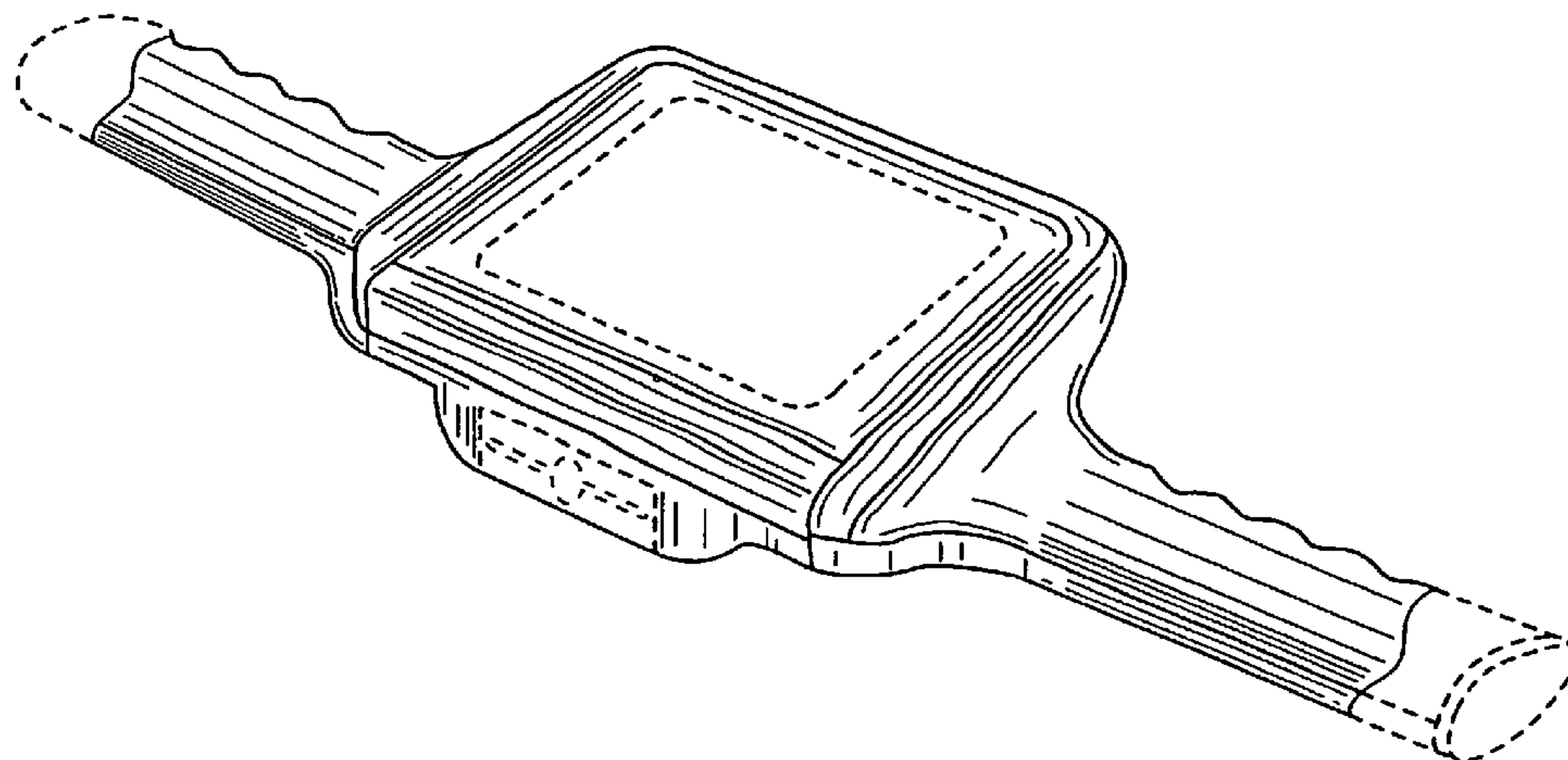

US D552,324 S

Page 2

U.S. PATENT DOCUMENTS

D282,731 S * 2/1986 Kain D12/133
 D287,370 S * 12/1986 Stoll et al. D18/7
 4,750,151 A 6/1988 Baus
 4,882,724 A 11/1989 Vela et al.
 D305,173 S * 12/1989 Nozawa D34/27
 D307,895 S 5/1990 Kitagawa et al.
 4,973,952 A 11/1990 Malec et al.
 4,988,025 A 1/1991 Lipton et al.
 D321,577 S * 11/1991 Ellis et al. D34/21
 D328,607 S * 8/1992 Brennan D18/7
 5,149,947 A 9/1992 Collins, Jr.
 5,158,310 A 10/1992 Tannehill et al.
 5,250,789 A 10/1993 Johnsen
 D341,691 S 11/1993 Begum et al.
 5,287,266 A 2/1994 Malec et al.
 5,295,064 A 3/1994 Malec et al.
 D346,366 S 4/1994 Kim et al.
 5,301,443 A 4/1994 Gori
 D347,505 S 5/1994 Machen et al.
 D347,719 S 6/1994 Machen et al.
 D348,965 S * 7/1994 Machen et al. D34/15
 D354,485 S 1/1995 Maeno et al.
 5,406,271 A 4/1995 Sonnendorfer et al.
 5,420,606 A 5/1995 Begum et al.
 5,424,524 A 6/1995 Ruppert et al.
 5,457,307 A 10/1995 Dumont
 5,483,472 A 1/1996 Overman
 5,544,040 A 8/1996 Gerbaulet
 D375,601 S 11/1996 Myers
 D376,459 S 12/1996 Myers
 5,630,068 A 5/1997 Vela et al.
 5,630,071 A 5/1997 Sakai et al.
 5,703,564 A 12/1997 Begum et al.
 D390,861 S 2/1998 Liao
 5,714,745 A 2/1998 Ju et al.
 D392,259 S 3/1998 Simmon
 5,729,697 A 3/1998 Schkolnick et al.
 5,739,513 A 4/1998 Watanabe
 5,773,954 A 6/1998 VanHorn
 5,821,512 A 10/1998 O'Hagan et al.
 5,821,513 A 10/1998 O'Hagan et al.
 5,836,051 A 11/1998 Myers
 5,841,115 A 11/1998 Shepley
 D404,761 S 1/1999 Tarpenning et al.
 5,859,414 A 1/1999 Grimes et al.
 5,890,135 A 3/1999 Powell
 5,898,158 A 4/1999 Shimizu et al.
 5,918,211 A 6/1999 Sloane
 5,979,757 A 11/1999 Tracy et al.
 5,984,182 A 11/1999 Murrah et al.
 6,000,610 A 12/1999 Talbott et al.
 6,012,244 A 1/2000 Begum et al.
 6,032,127 A 2/2000 Schkolnick et al.
 D425,681 S * 5/2000 Johnson et al. D34/27
 6,105,867 A 8/2000 Shimizu et al.
 6,112,857 A 9/2000 Morrison
 6,119,935 A 9/2000 Jelen et al.
 6,123,259 A 9/2000 Ogasawara
 6,129,276 A 10/2000 Jelen et al.
 6,168,079 B1 1/2001 Becker et al.
 6,177,880 B1 1/2001 Begum
 6,189,788 B1 2/2001 Sherman et al.
 D438,569 S * 3/2001 Hofmann D20/10
 D438,849 S 3/2001 Adachi et al.
 6,199,753 B1 3/2001 Tracy et al.
 D448,009 S * 9/2001 Lavelle et al. D14/125

6,323,753 B2 11/2001 Begum
 6,327,570 B1 12/2001 Stevens
 D454,563 S 3/2002 Brown et al.
 6,386,450 B1 5/2002 Ogasawara
 D460,759 S 7/2002 West et al.
 6,434,530 B1 8/2002 Sloane et al.
 6,435,407 B1 8/2002 Fiordelisi
 6,453,588 B1 9/2002 Lykens
 6,456,981 B1 9/2002 Dejaeger et al.
 D464,646 S 10/2002 Lin
 6,484,939 B1 11/2002 Blaeuer
 6,513,015 B2 1/2003 Ogasawara
 6,533,173 B2 3/2003 Benyak
 6,539,417 B2 3/2003 Stern
 6,595,417 B2 7/2003 O'Hagan et al.
 6,619,546 B1 9/2003 Nguyen et al.
 D480,760 S 10/2003 Wieth et al.
 D481,057 S 10/2003 Brady et al.
 D482,172 S 11/2003 Johnson et al.
 D482,836 S * 11/2003 Van Lingham, Jr. D34/27
 D483,361 S 12/2003 Yao et al.
 6,725,206 B1 4/2004 Coveley
 D492,303 S 6/2004 Schlieffers et al.
 D494,174 S * 8/2004 Hsu Li D14/374
 D494,970 S 8/2004 Chen et al.
 D495,703 S 9/2004 Ma et al.
 D495,707 S * 9/2004 Hoehn D14/374
 6,817,066 B1 * 11/2004 Williams et al. 16/435
 6,845,656 B2 1/2005 Matsumura et al.
 D501,888 S * 2/2005 Arceta D20/10
 6,854,656 B2 2/2005 Matsumori
 6,910,697 B2 6/2005 Varatharajah et al.
 6,912,398 B1 6/2005 Domnitz
 6,928,343 B2 8/2005 Cato
 D509,827 S 9/2005 Johnson
 D510,784 S 10/2005 Van Lingham, Jr.
 D511,547 S 11/2005 Andersson et al.
 D528,146 S * 9/2006 Fitch D18/4.4
 2001/0007450 A1 7/2001 Begum
 2001/0028301 A1 10/2001 Geiger et al.
 2002/0165778 A1 11/2002 O'Hagan et al.
 2003/0132298 A1 7/2003 Swartz et al.
 2004/0073489 A1 4/2004 Varatharajah et al.
 2004/0215530 A1 10/2004 Rawson et al.
 2004/0262385 A1 * 12/2004 Blaeuer 235/383
 2005/0040230 A1 2/2005 Swartz et al.

FOREIGN PATENT DOCUMENTS

JP 2000-155683 6/2000
 WO WO-97/29452 A1 8/1997

OTHER PUBLICATIONS

Wincor Nixdorf; "SNIKEY"; www.wincor-nixdorf.com; Apr. 7, 2005.
 Wincor Nixdorf; "Beetle/NETPOS Scalable Thin Client Terminal"; www.wincor-nixdorf.com; Apr. 15, 2004.
 Wincor Nixdorf; "POS Terminal Beetle/IPOS"; www.wincor-nixdorf.com; Oct. 15, 2004.
 Klever Marketing; "EMarketing's Billion Dollar Opportunity"; www.kleverkart.com; 2005; and Fujitsu; "The Fujitsu Difference—U-Scan Shopper"; www.fujitsu.com; 2005.
 Cuesol; "Enhancing the Customer Experience"; www.cuesol.com; 2005.
 Intermedia kiosks-news-Supermarket News, (Apr. 2001).
 Metro Group Future Store Initiative, Personal Shopping Assistant, www.future-store.org; Jan. 17, 2006.

* cited by examiner

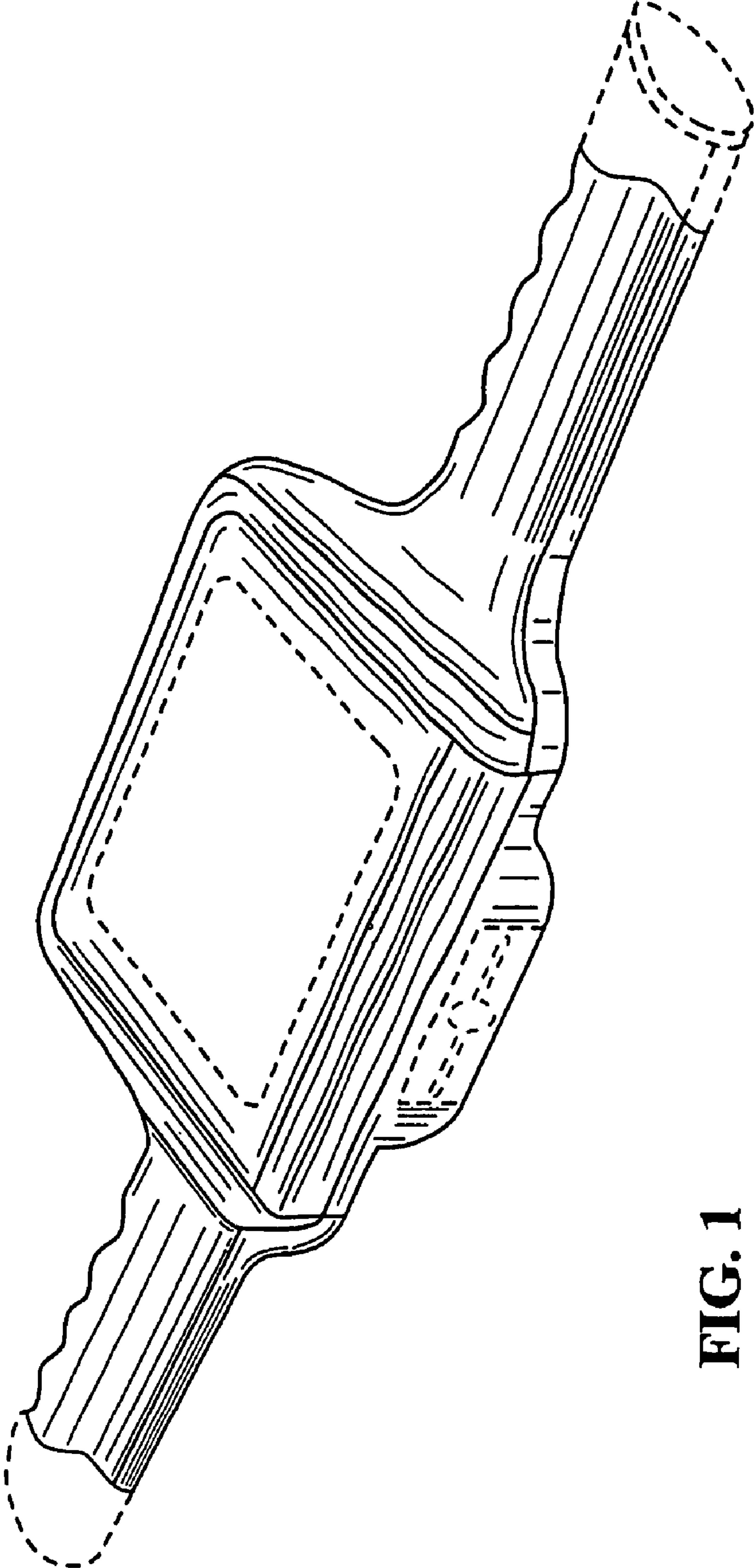

FIG. 1

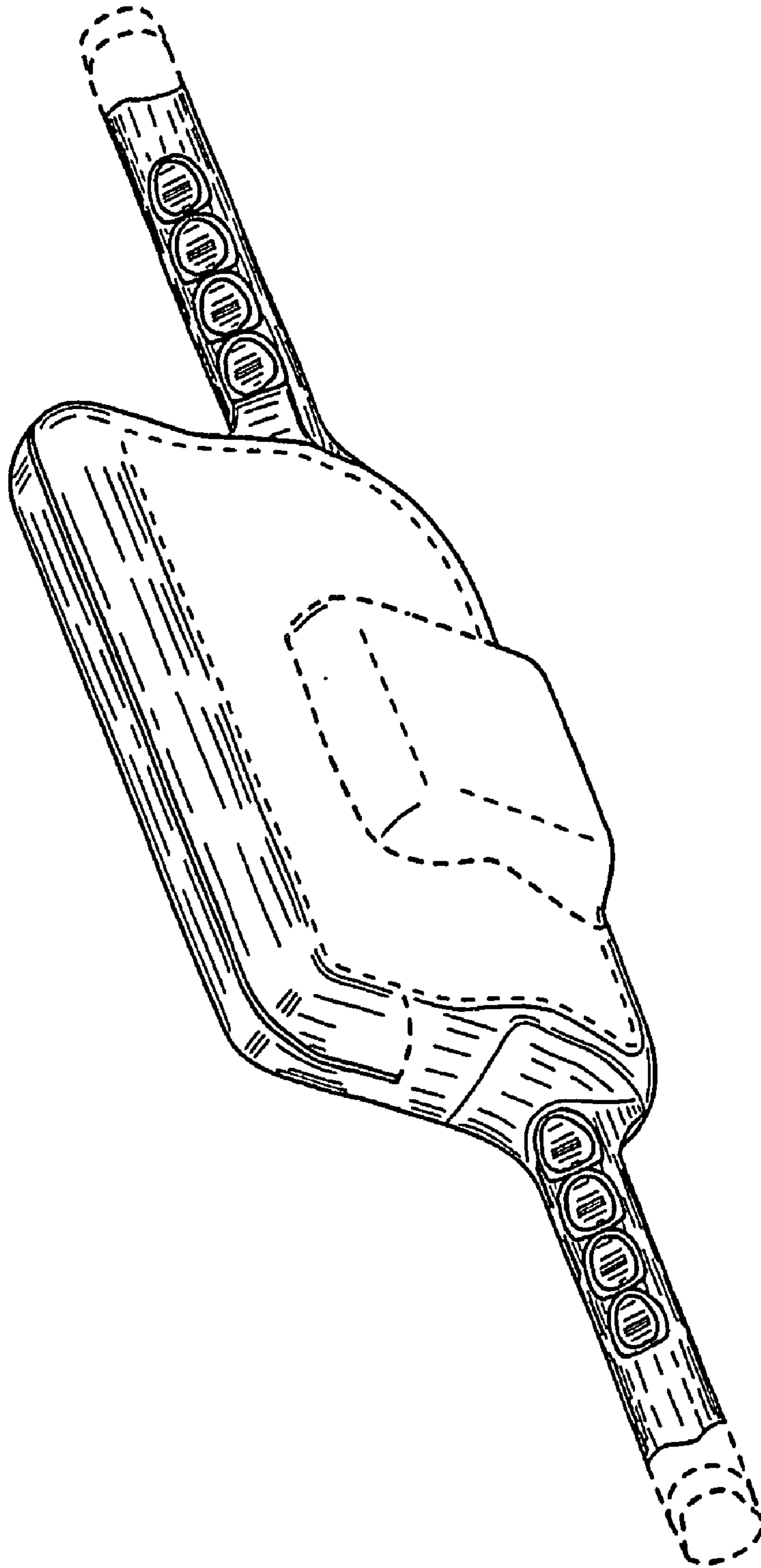

FIG. 2

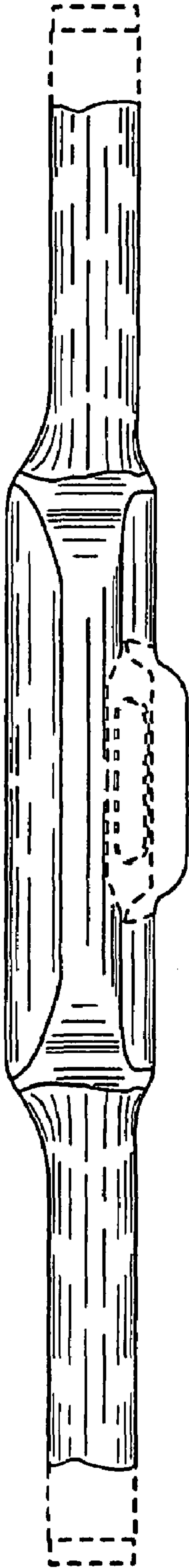
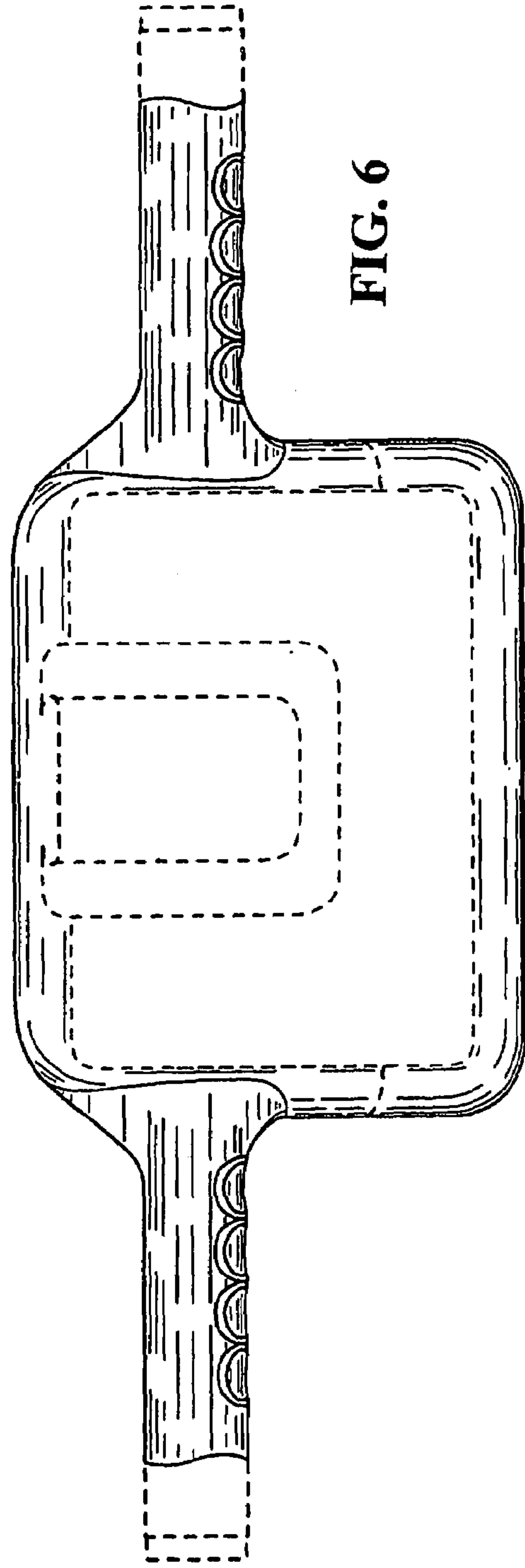
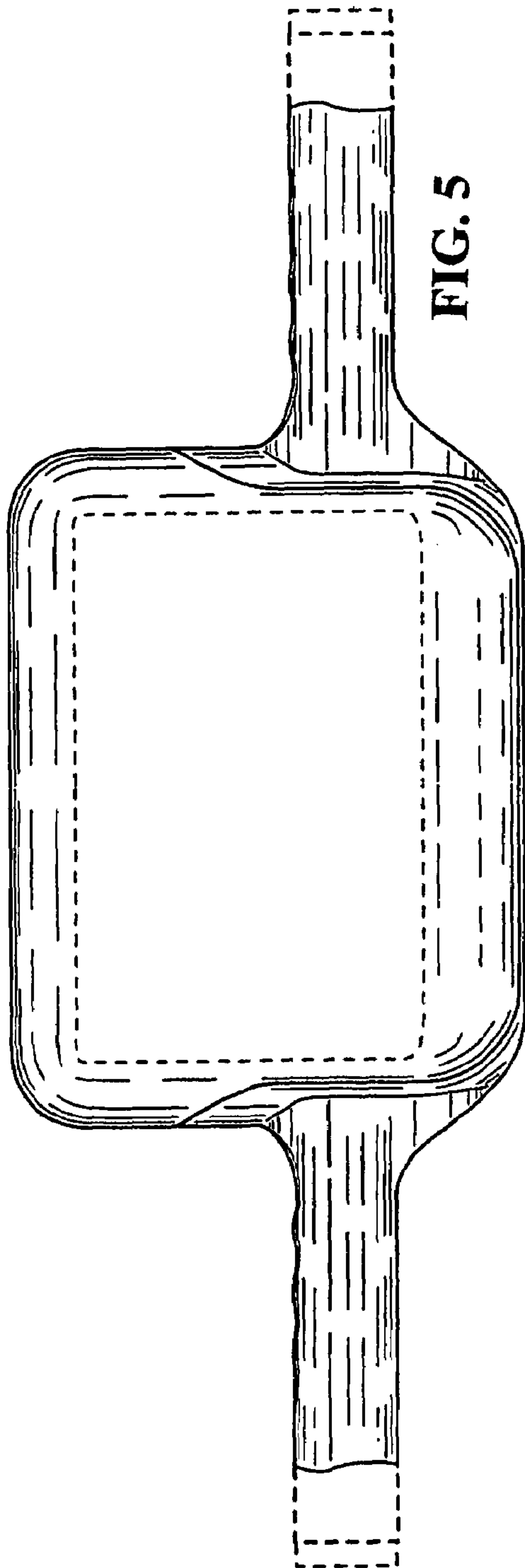

FIG. 3



FIG. 4



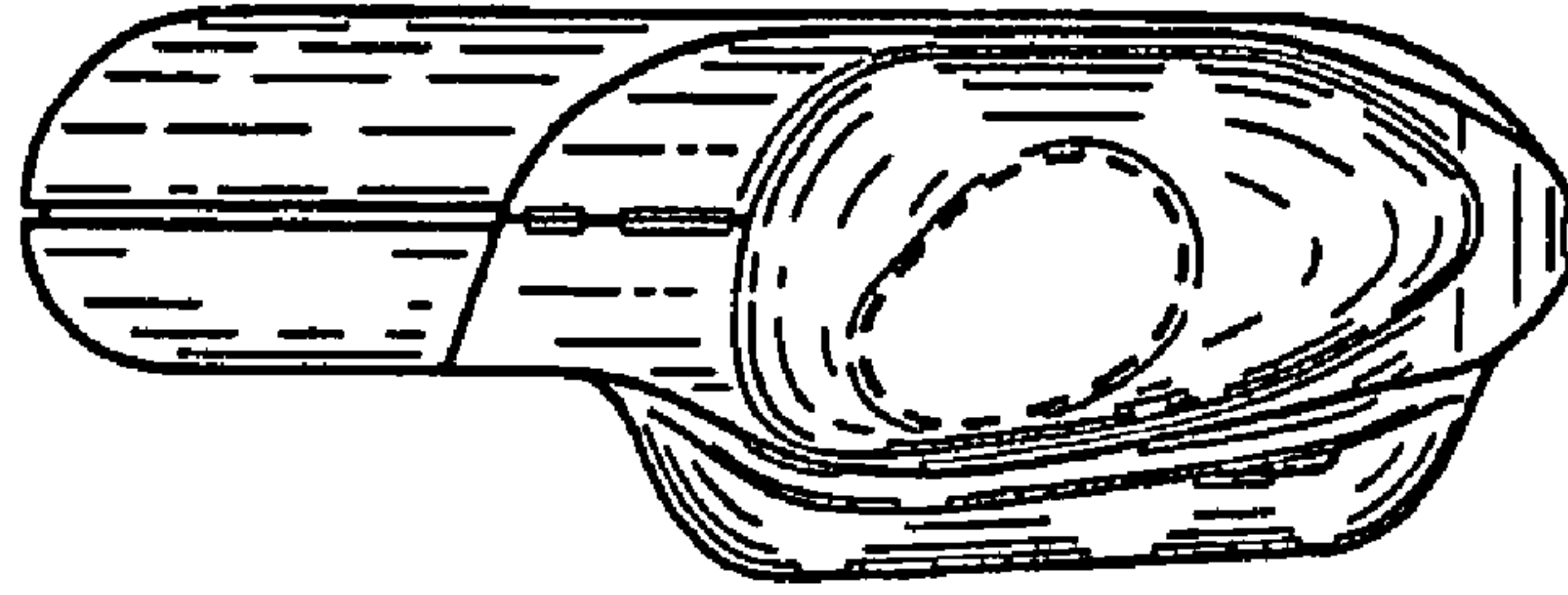

FIG. 7

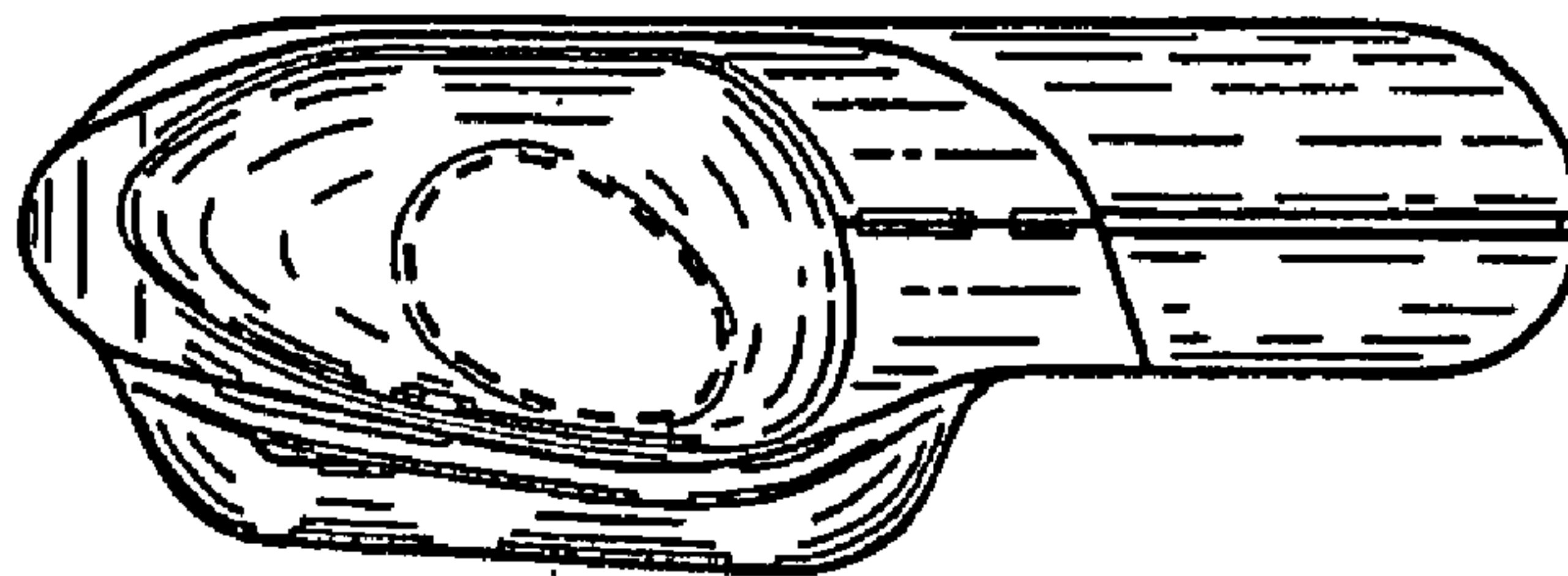

FIG. 8