



US00D552307S

(12) **United States Design Patent**
Renforth et al.

(10) **Patent No.:** **US D552,307 S**

(45) **Date of Patent:** **** Oct. 2, 2007**

(54) **FOOTBALL-SHAPED PET TOY**

(75) Inventors: **Jack W. Renforth**, Aurora, CO (US);
Larry Deliman, Englewood, CO (US);
Charles Costello, Louisville, CO (US)

(73) Assignee: **Aspen Pet Products, Inc.**, Denver, CO (US)

(**) Term: **14 Years**

(21) Appl. No.: **29/235,078**

(22) Filed: **Jul. 26, 2005**

(51) **LOC (8) Cl.** **30-99**

(52) **U.S. Cl.** **D30/160**

(58) **Field of Classification Search** D30/160,
D30/108, 112, 118-119; D21/405, 484, 486,
D21/498, 611, 617, 621, 649, 707, 713-714;
D24/193-195; 119/702-703, 706-711; 273/118 D,
273/153 R, 288; 434/278; 446/46, 108,
446/125, 369, 419; 473/571, 596; 606/235
See application file for complete search history.

(56) **References Cited**

U.S. PATENT DOCUMENTS

927,499 A * 7/1909 Davis 434/214

(Continued)

Primary Examiner—Cathy Anne MacCormac

(74) *Attorney, Agent, or Firm*—Dorsey & Whitney LLP

(57) **CLAIM**

I claim the ornamental design for a football-shaped pet toy, as shown and described.

DESCRIPTION

FIG. 1 is a top perspective view of a first embodiment of the present invention taking the form of a football-shaped pet toy;

FIG. 2 is a bottom perspective view of the football-shaped pet toy of FIG. 1;

FIG. 3 is a front view of the football-shaped pet toy of FIG. 1;

FIG. 4 is a back view of the football-shaped pet toy of FIG. 1;

FIG. 5 is a right side view of the football-shaped pet toy of FIG. 1;

FIG. 6 is a left side view of the football-shaped pet toy of FIG. 1;

FIG. 7 is a top view of the football-shaped pet toy of FIG. 1;

FIG. 8 is a bottom view of the football-shaped pet toy of FIG. 1;

FIG. 9 is a perspective view of a second embodiment of the present invention;

FIG. 10 is a front view of the football-shaped pet toy of FIG. 9;

FIG. 11 is a back view of the football-shaped pet toy of FIG. 9;

FIG. 12 is a right side view of the football-shaped pet toy of FIG. 9;

FIG. 13 is a left side view of the football-shaped pet toy of FIG. 9;

FIG. 14 is a top view of the football-shaped pet toy of FIG. 9; and,

FIG. 15 is a bottom view of the football-shaped pet toy of FIG. 9.

The broken lines are for purposes of illustration only and form no part of the claimed design.

1 Claim, 8 Drawing Sheets

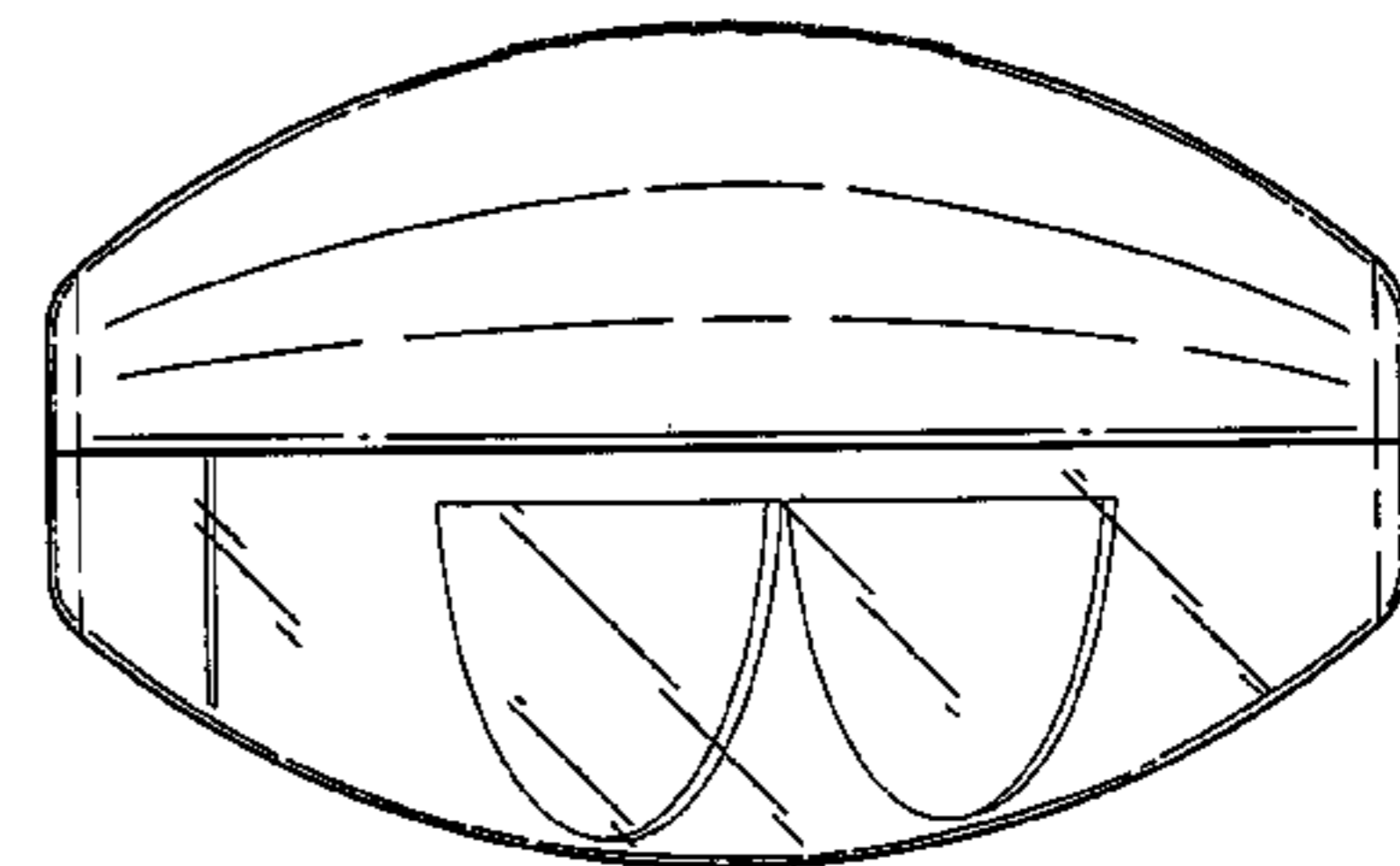
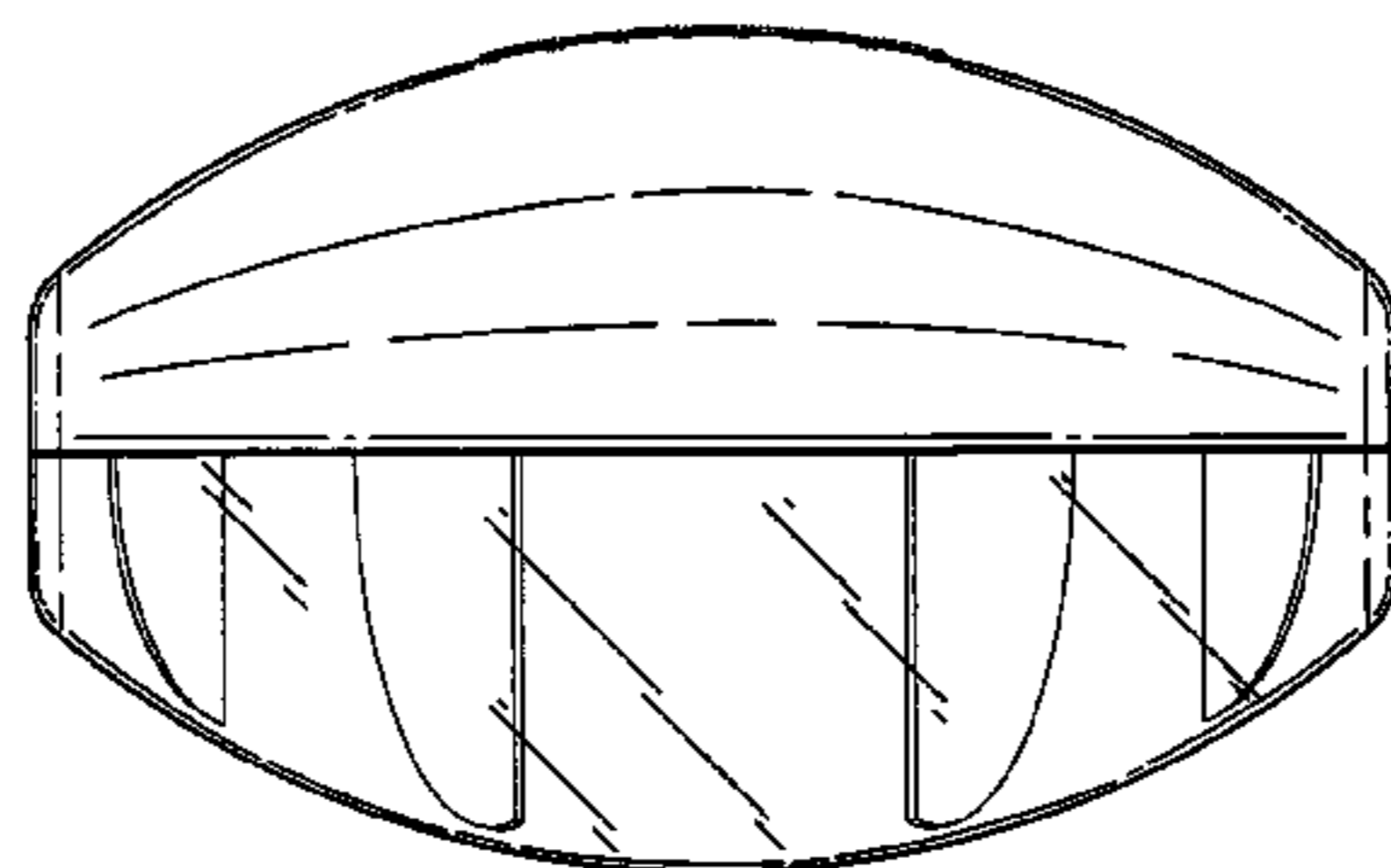
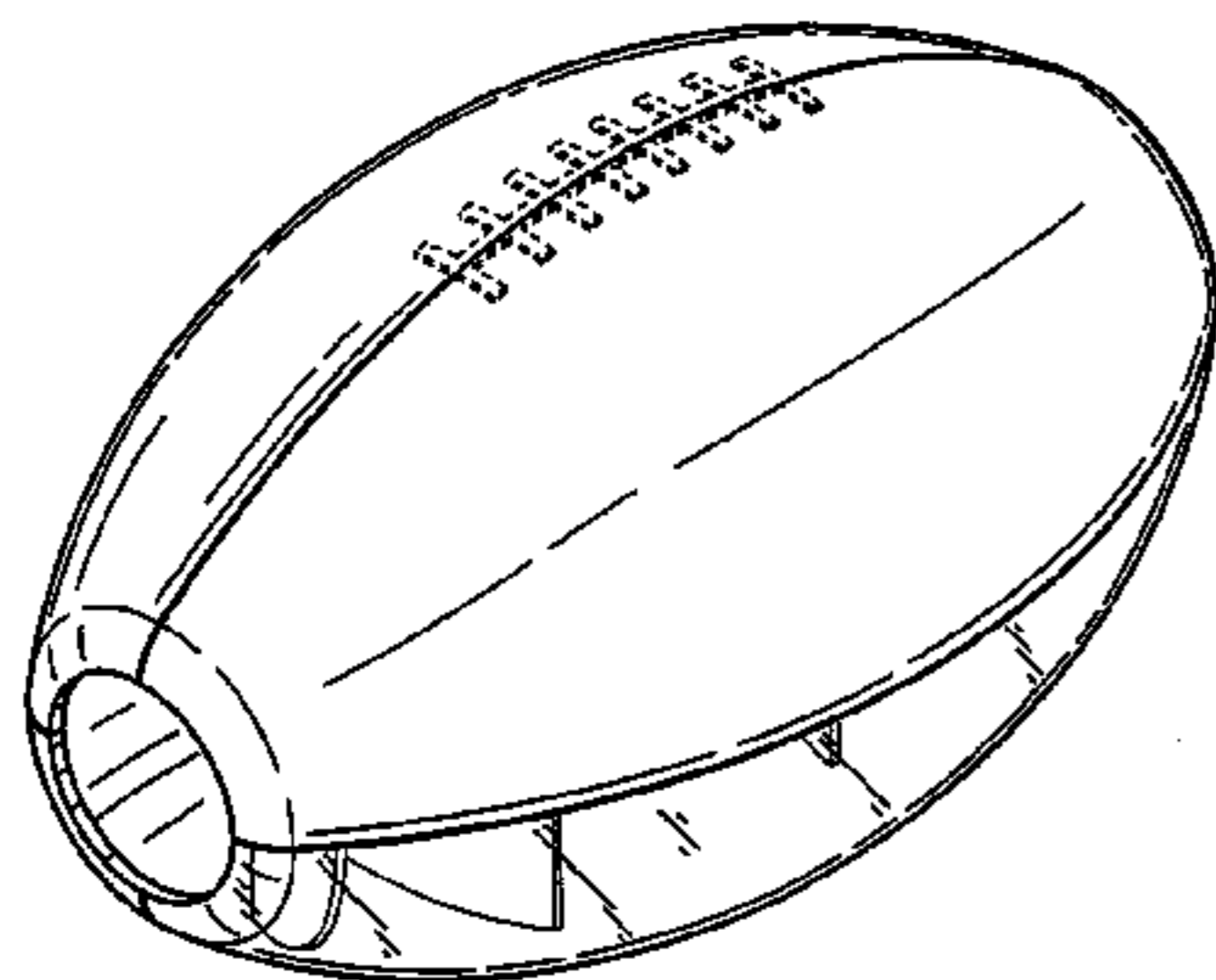

US D552,307 S

Page 2

U.S. PATENT DOCUMENTS

3,884,466	A *	5/1975	MacDonald et al.	473/613	5,611,532	A *	3/1997	Forrest, Sr.	473/576
4,003,574	A *	1/1977	MacDonald et al.	473/613	D386,229	S *	11/1997	Hicks	D21/712
4,451,038	A *	5/1984	Nagy	273/110	5,819,690	A *	10/1998	Brown	119/707
4,907,537	A *	3/1990	Shirk	119/707	6,158,391	A *	12/2000	Simonetti	119/707
5,066,012	A *	11/1991	Stark	473/570	6,237,538	B1 *	5/2001	Tsengas	119/707
5,098,571	A *	3/1992	Maebashi	210/500.23	6,485,349	B1 *	11/2002	Snyder et al.	446/227
5,123,645	A *	6/1992	MacDonald et al.	473/594	6,526,912	B1 *	3/2003	Ottoson	119/707
5,458,329	A *	10/1995	Bushman et al.	473/613	D494,716	S *	8/2004	Chang	D30/160

* cited by examiner

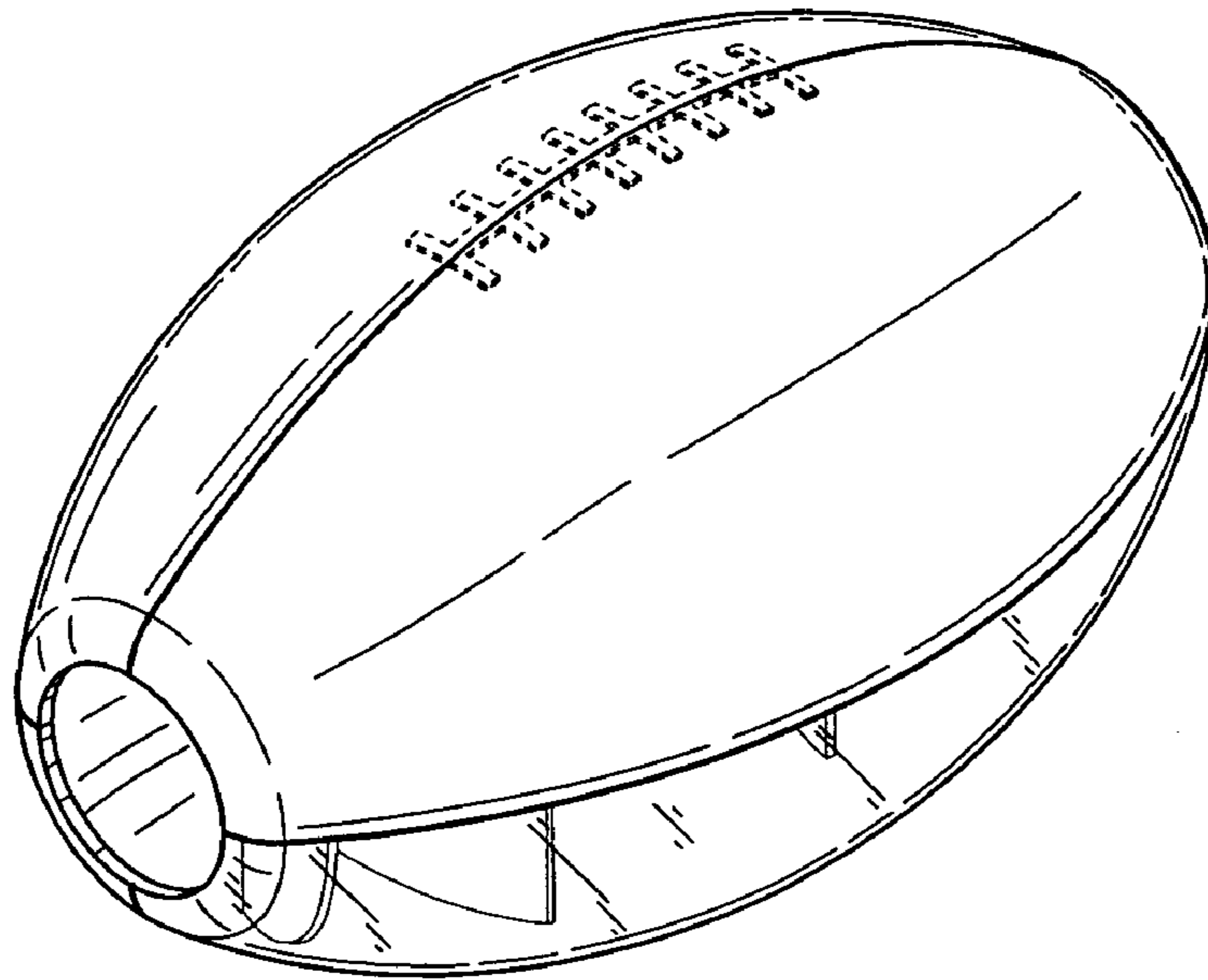

FIG.1

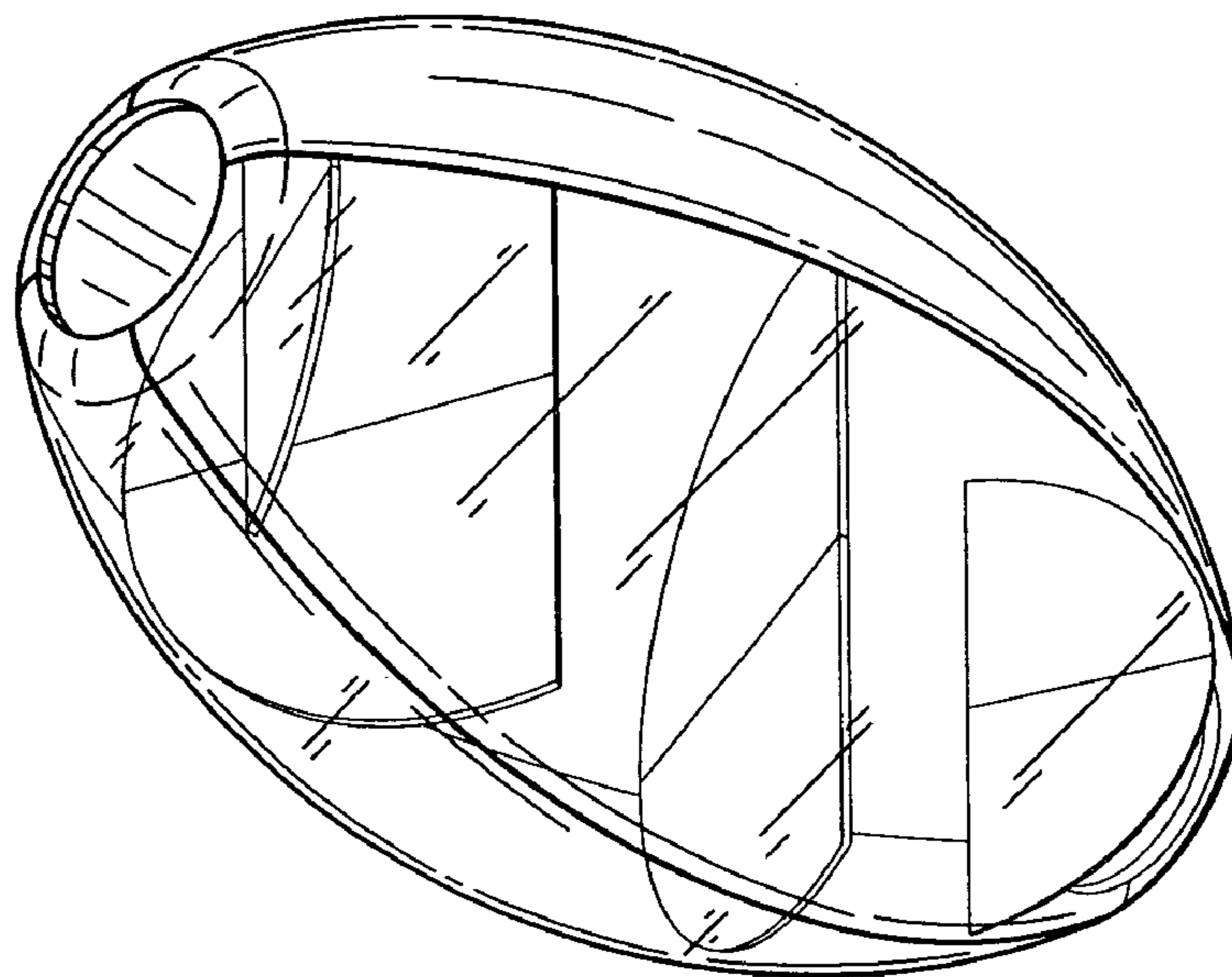

FIG.2

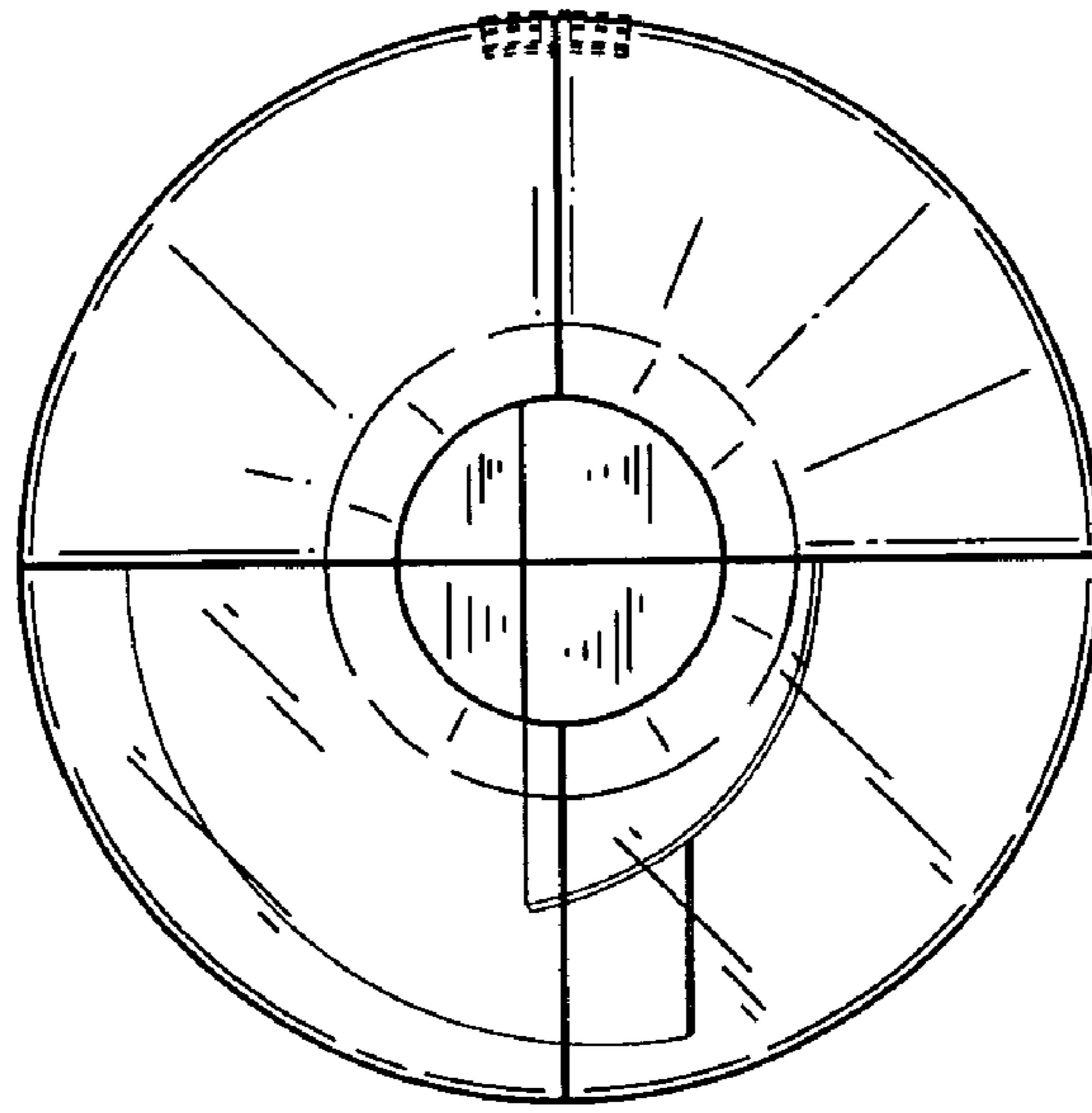

FIG.3

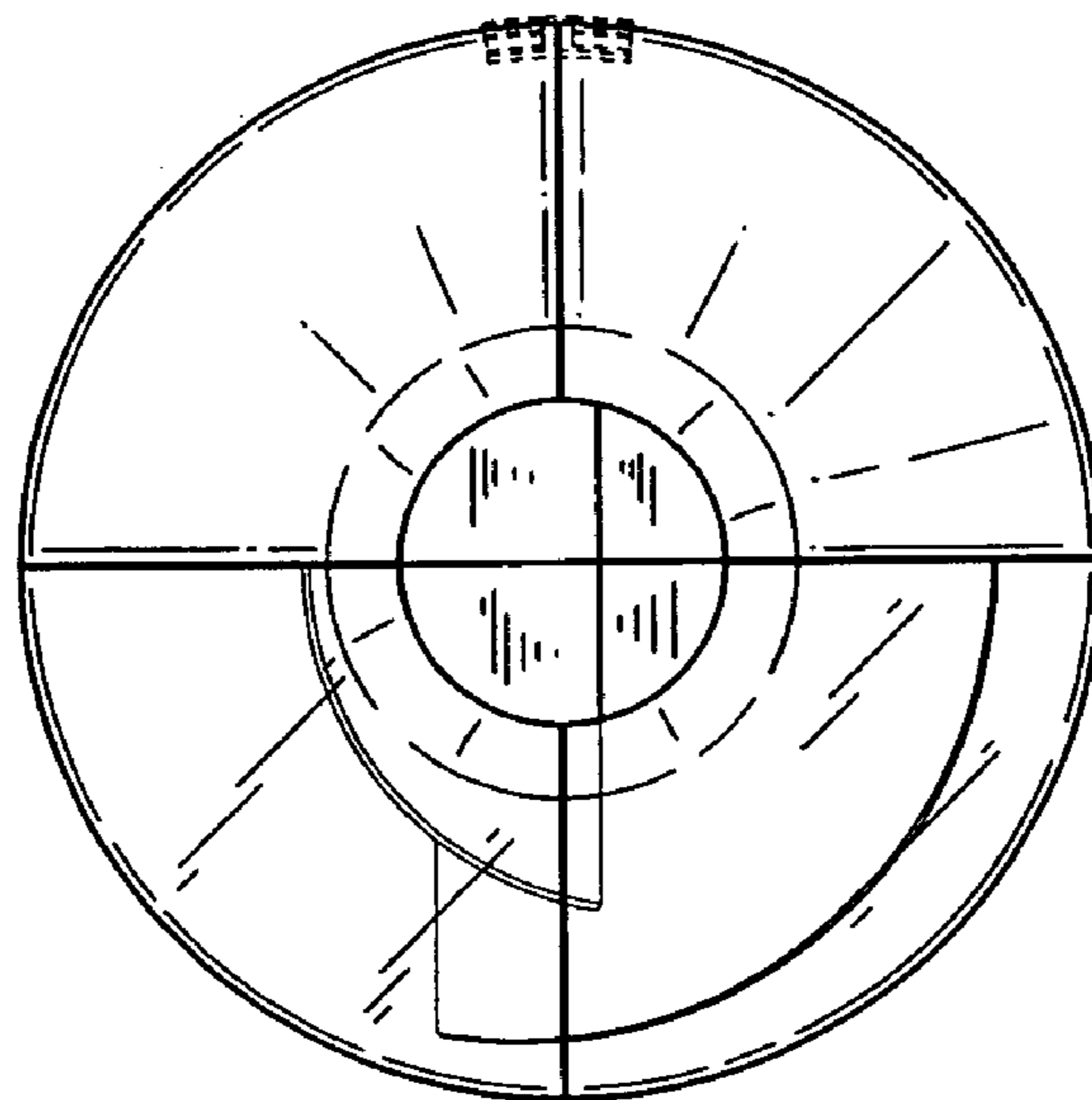

FIG.4

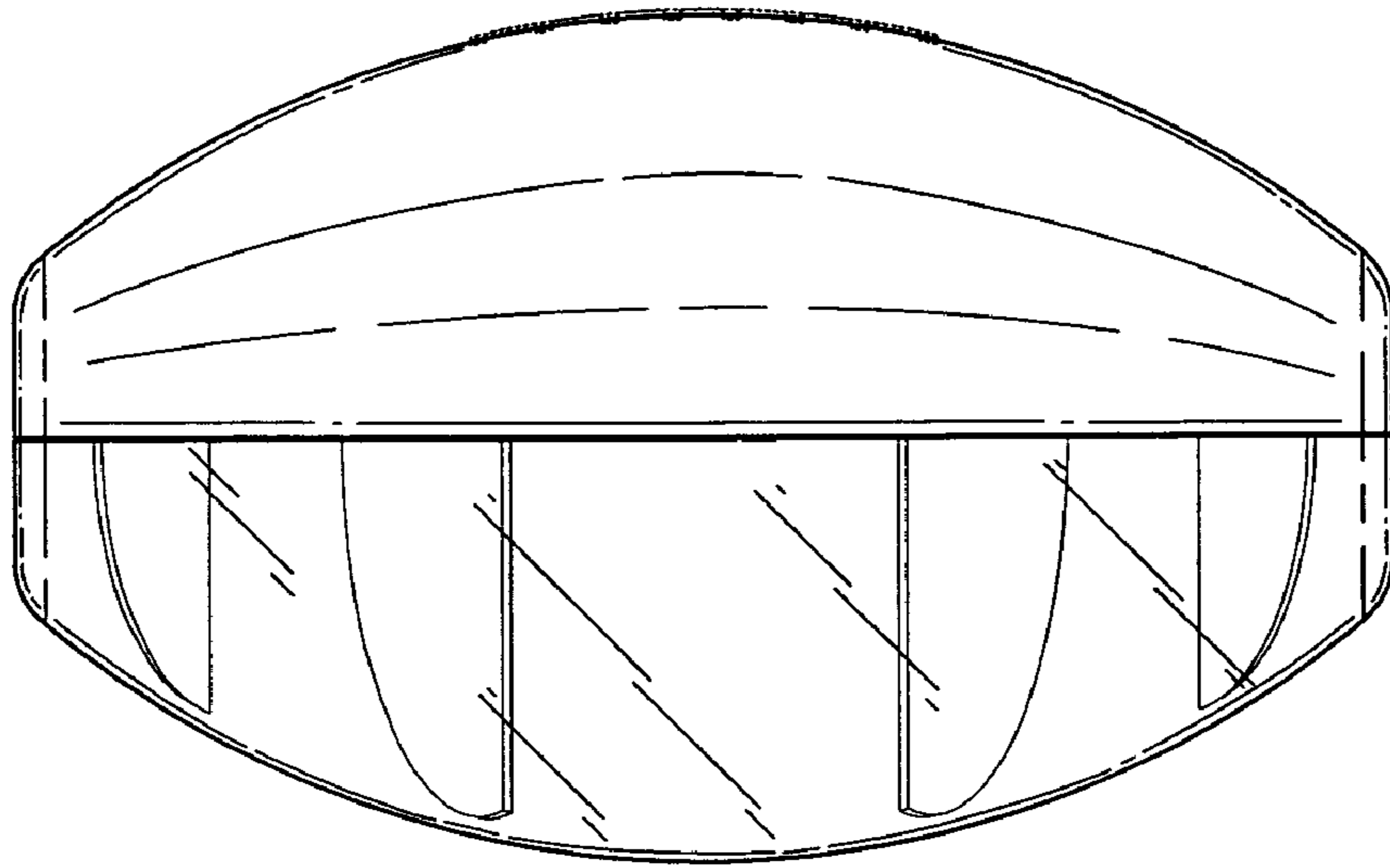

FIG. 5

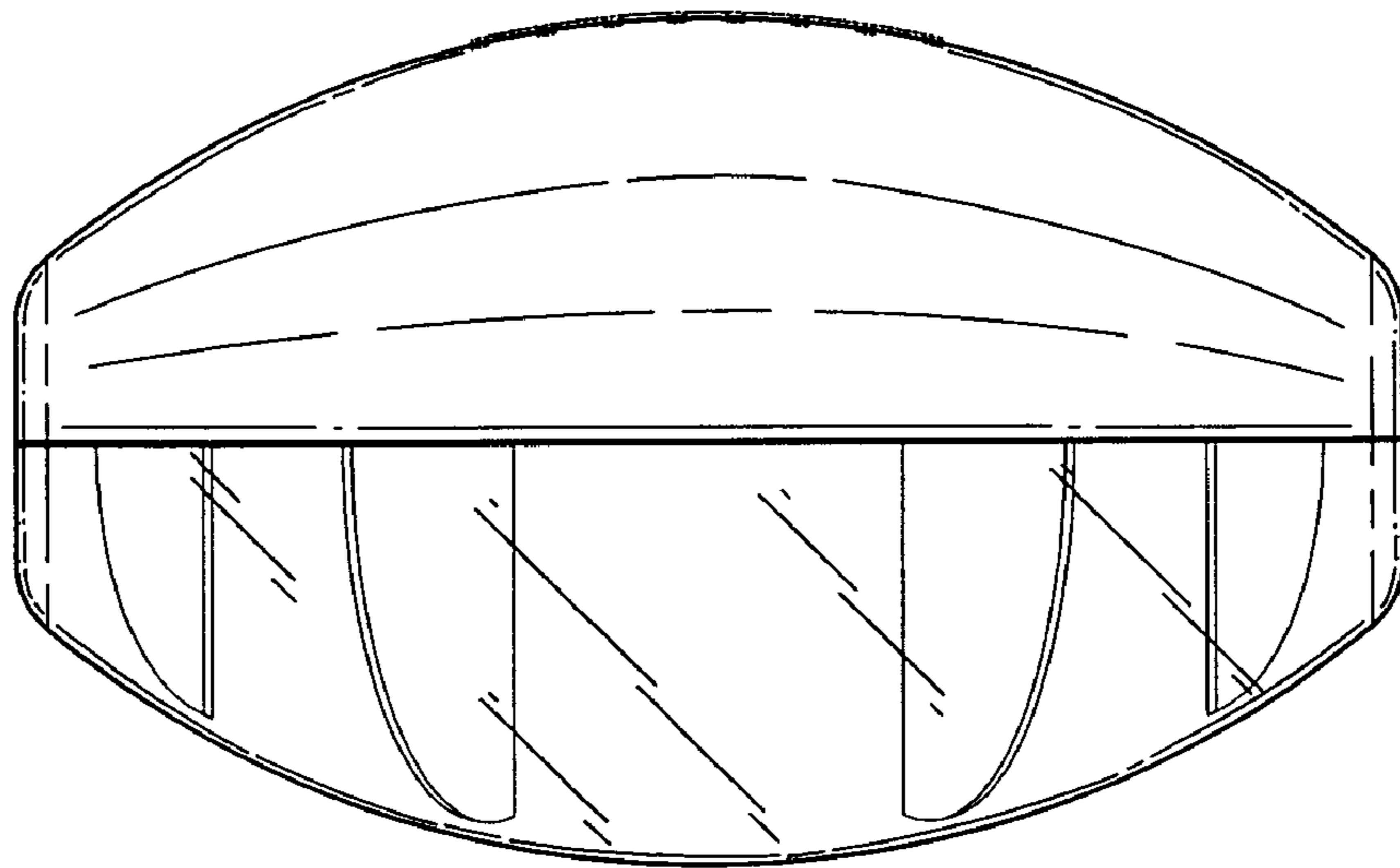

FIG. 6

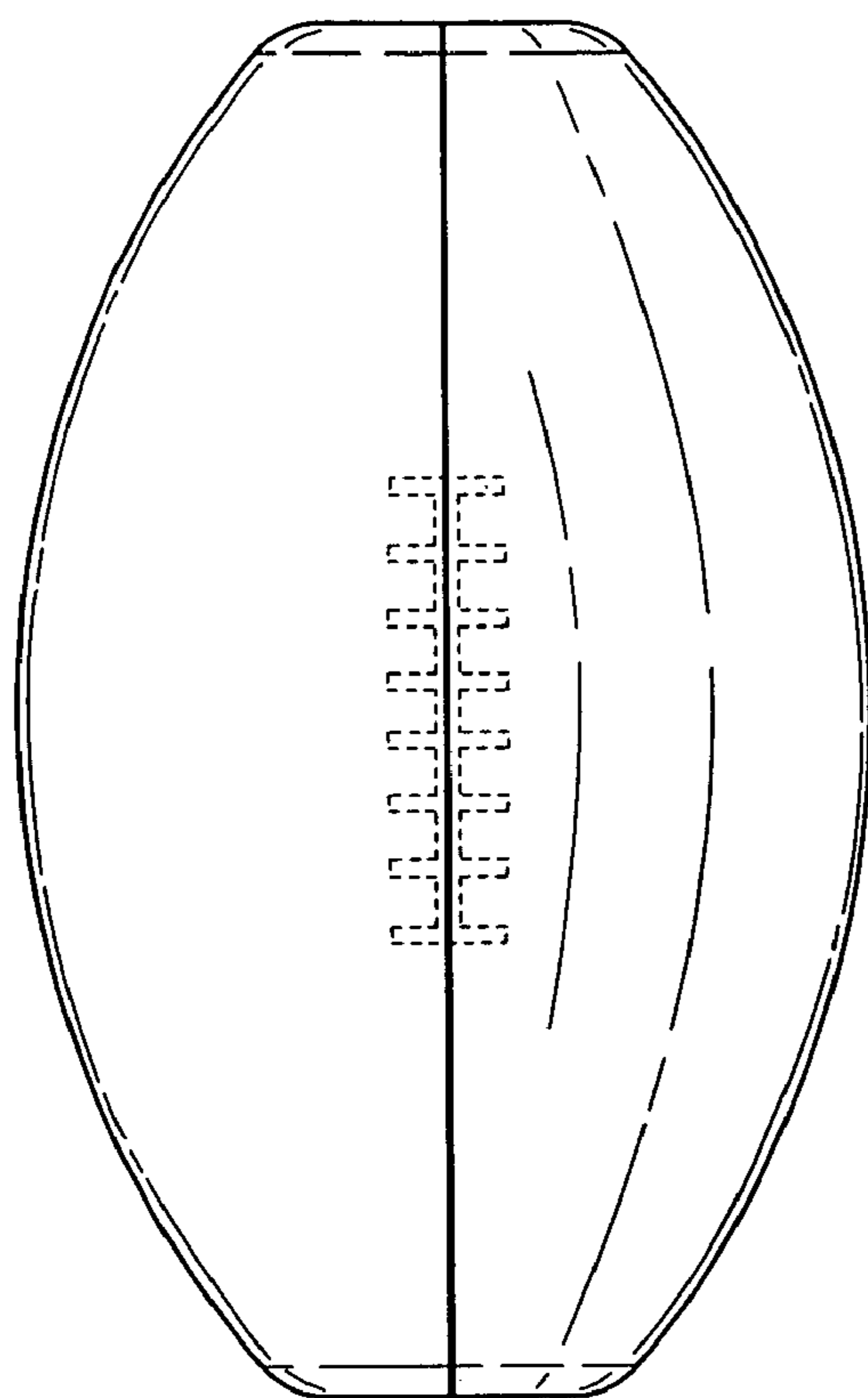

FIG. 7

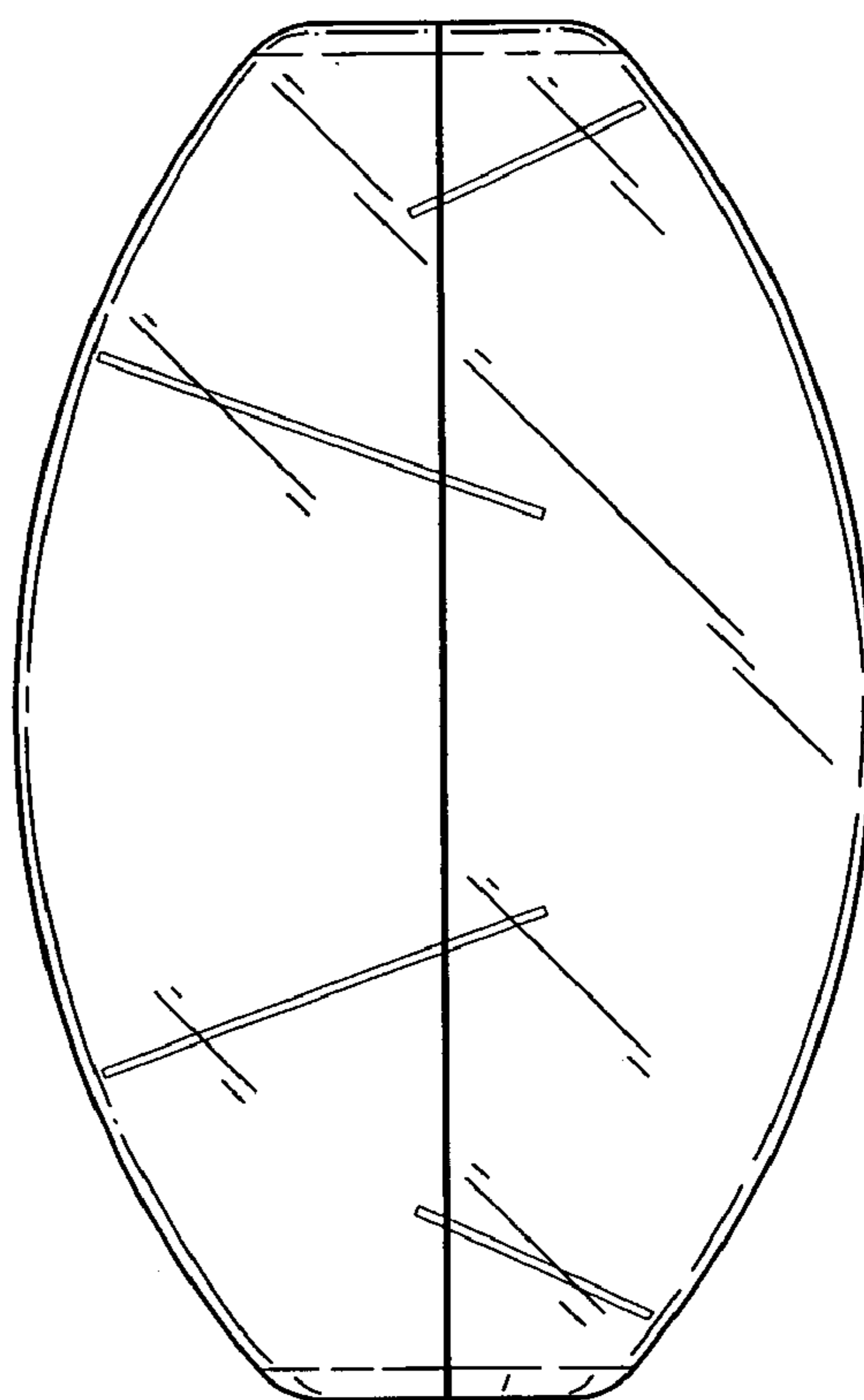

FIG. 8

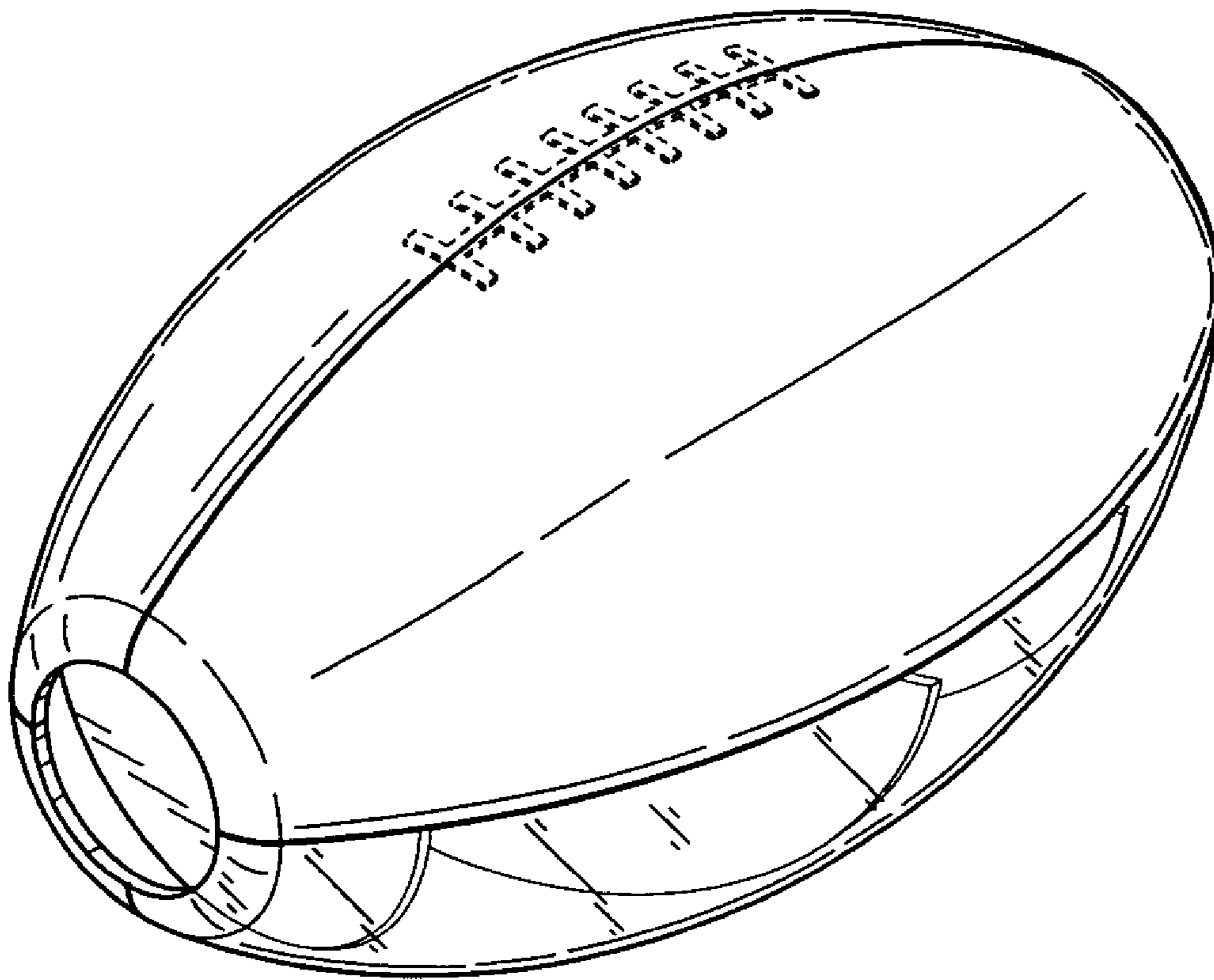

FIG.9

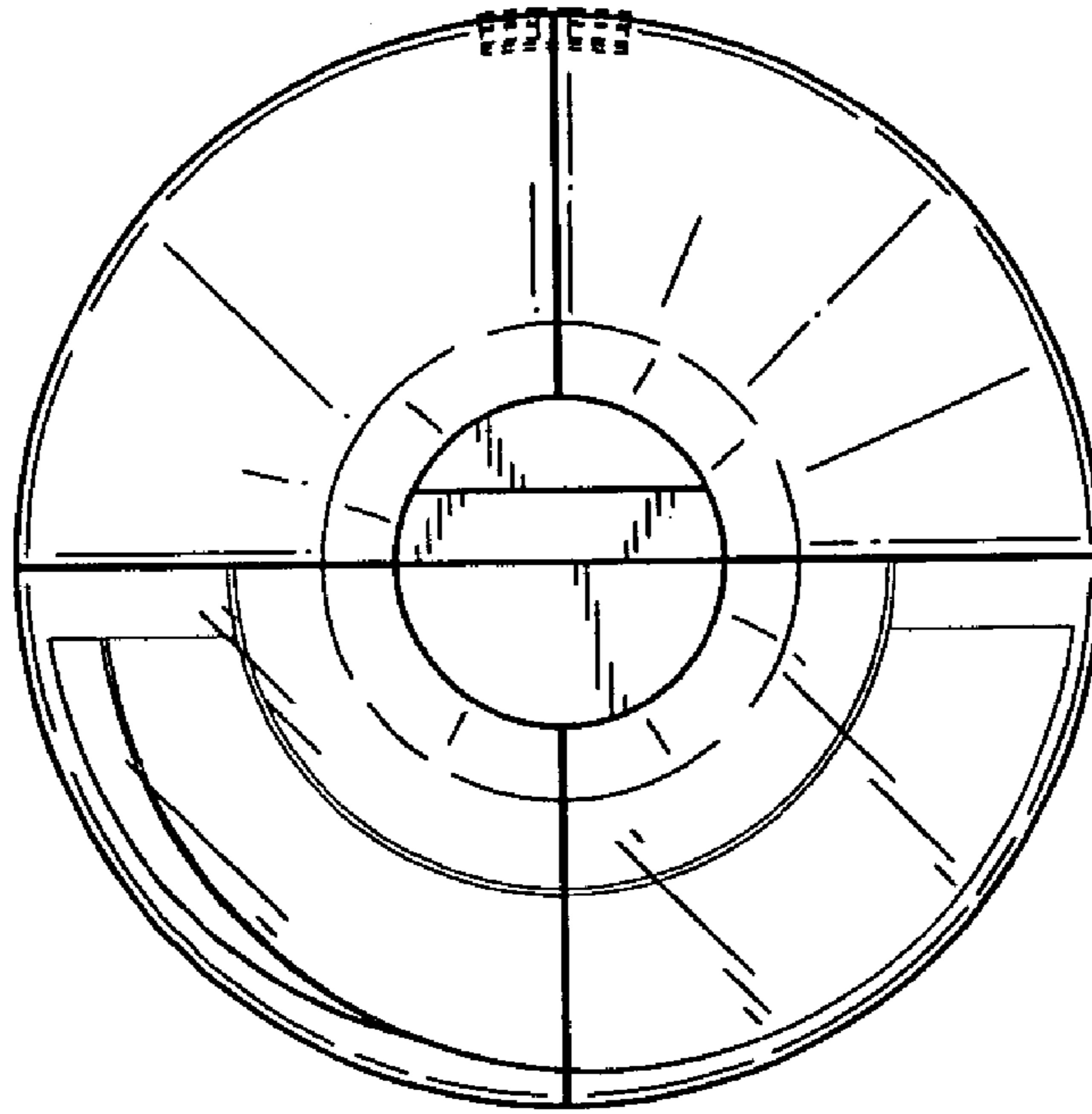

FIG. 10

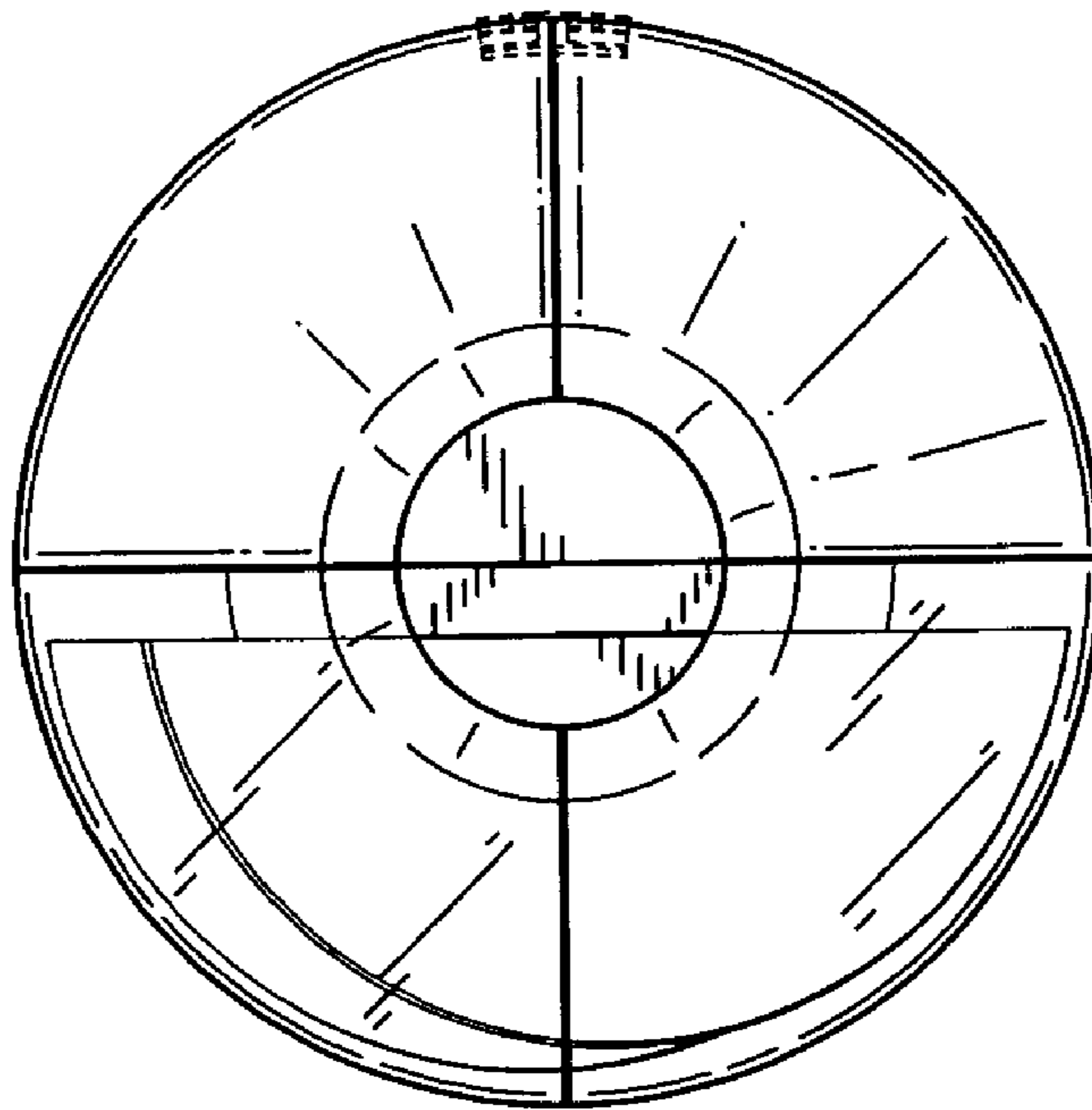

FIG. 11

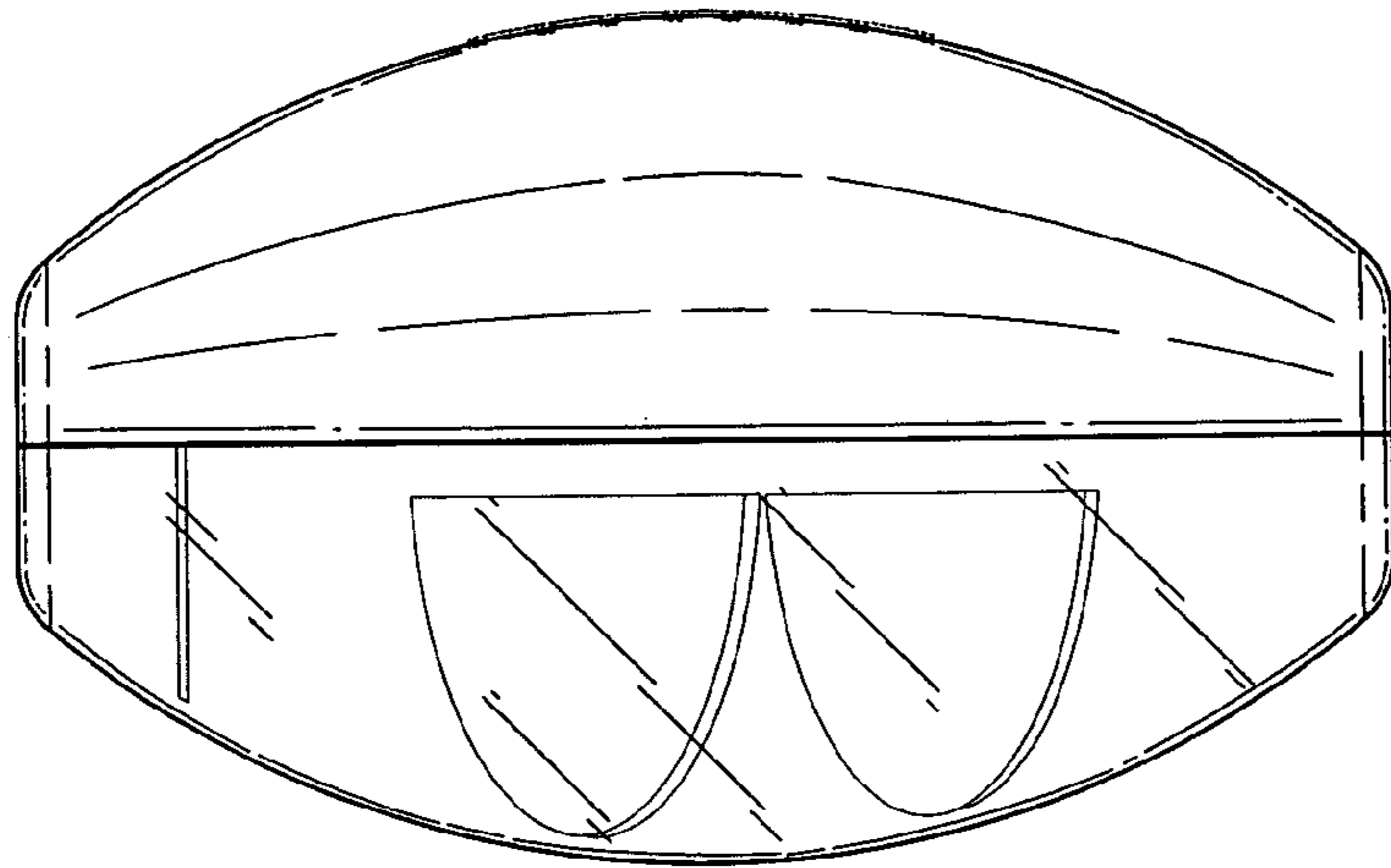

FIG.12

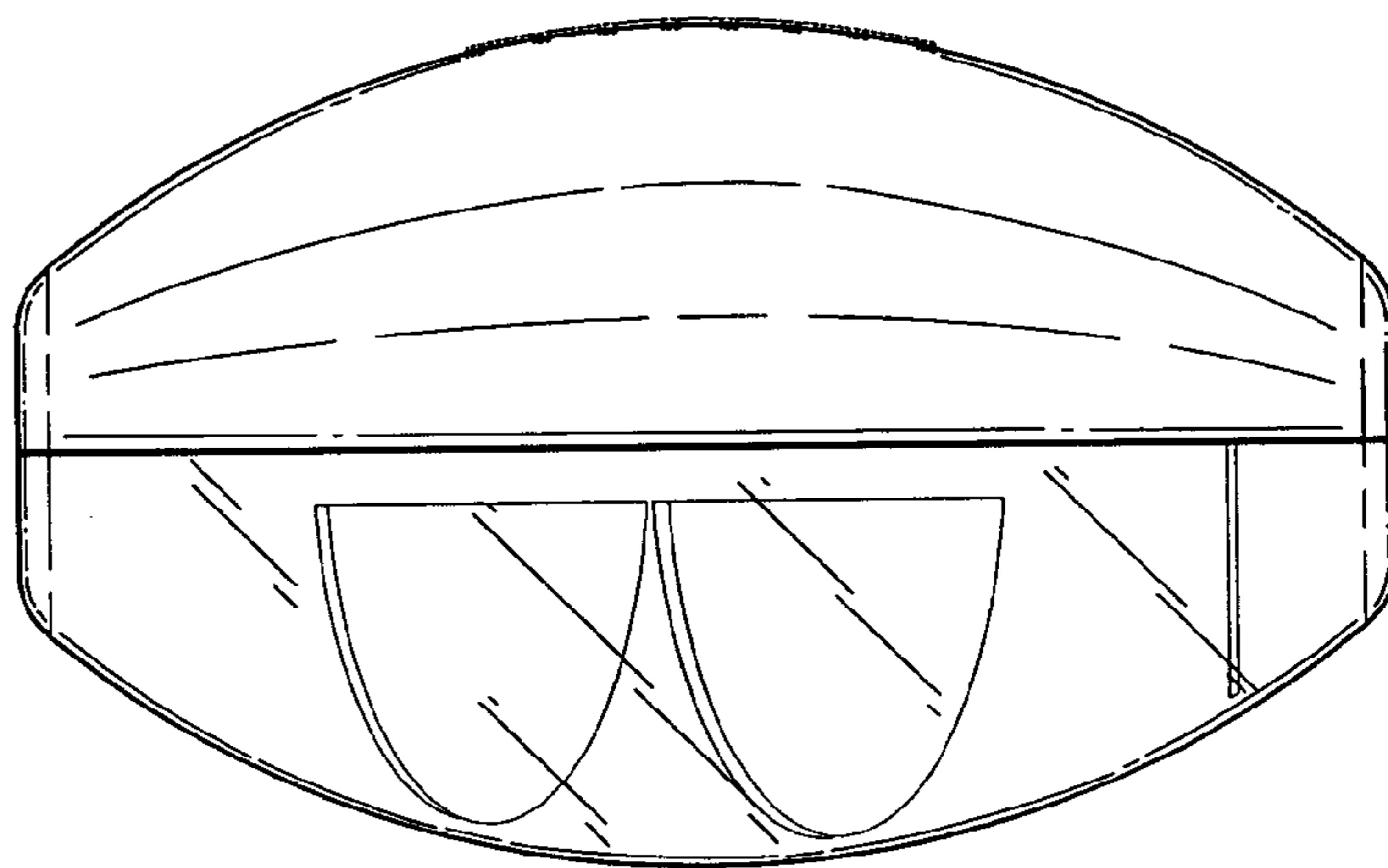

FIG.13

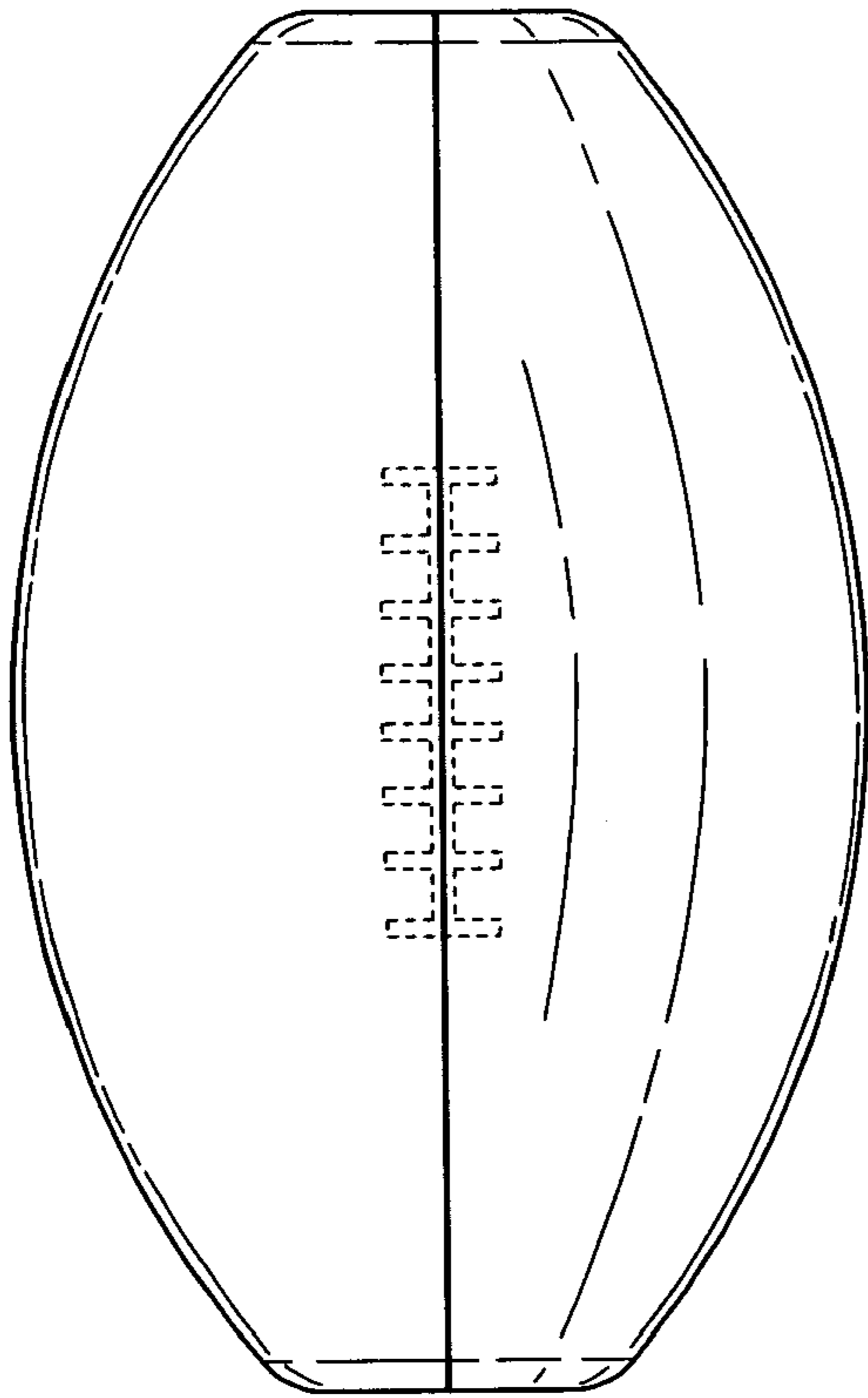

FIG.14

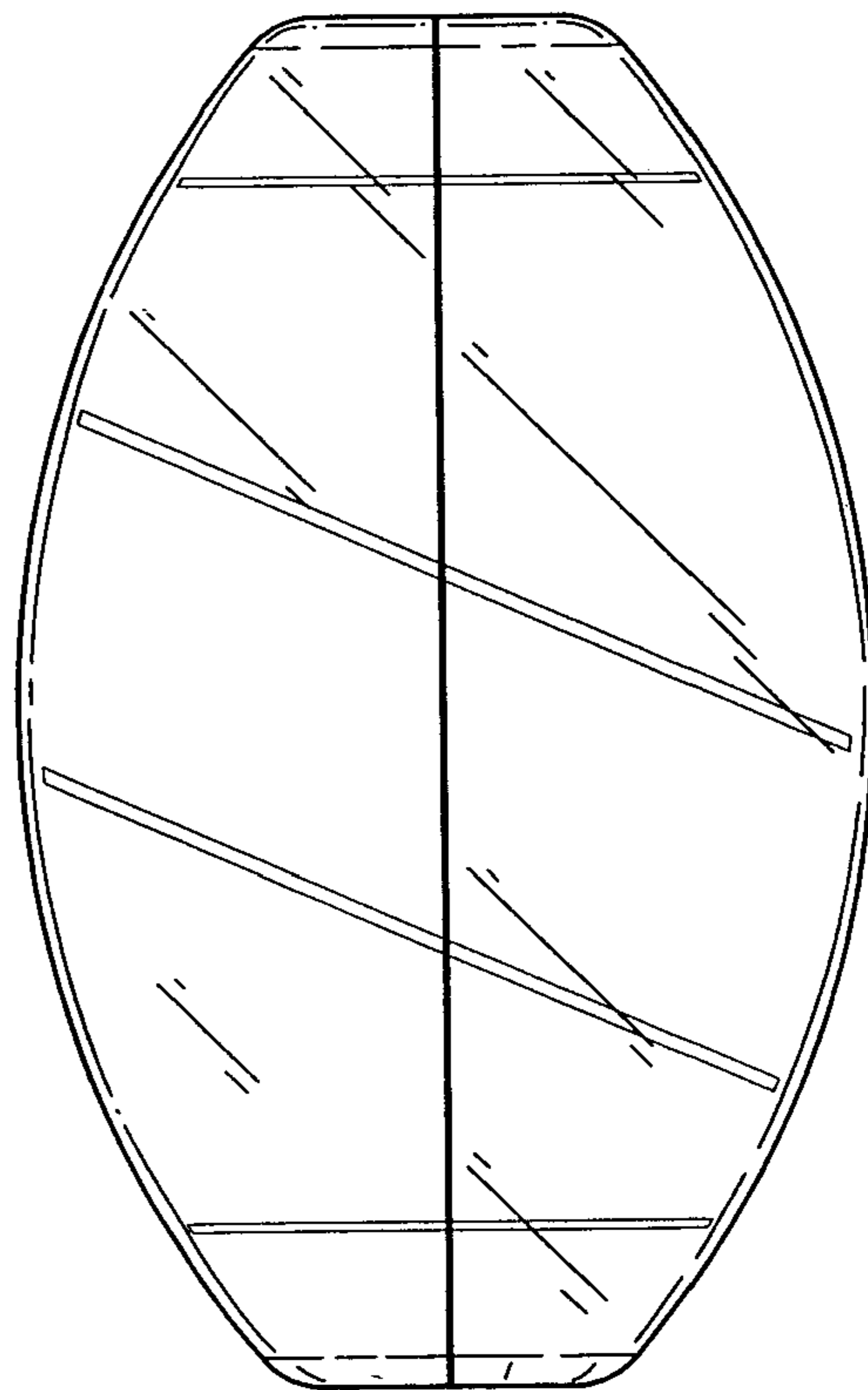

FIG.15