



US00D552275S

(12) **United States Design Patent**
Nishimoto et al.

(10) **Patent No.:** **US D552,275 S**
(45) **Date of Patent:** **** Oct. 2, 2007**

(54) **REAR COMBINATION LAMP FOR A MOTOR SCOOTER**

D523,980 S * 6/2006 Ito et al. D26/28

FOREIGN PATENT DOCUMENTS

(75) Inventors: **Akihiko Nishimoto**, Wako (JP); **Fujio Nakamura**, Wako (JP)

JP	937475	6/1995
JP	1024042 S	10/1998
JP	1040182	2/1999
JP	1120237	7/2001

(73) Assignee: **Honda Motor Co., Ltd.**, Tokyo (JP)

(**) Term: **14 Years**

* cited by examiner

(21) Appl. No.: **29/262,498**

Primary Examiner—Marcus A. Jackson

(22) Filed: **Jul. 5, 2006**

(74) *Attorney, Agent, or Firm*—Birch, Stewart, Kolasch & Birch, LLP

(30) **Foreign Application Priority Data**

(57) **CLAIM**

Jan. 5, 2006 (JP) 2006-000020

The ornamental design for a rear combination lamp for a motor scooter, as shown and described.

(51) **LOC (8) Cl.** **26-06**

DESCRIPTION

(52) **U.S. Cl.** **D26/28**

(58) **Field of Classification Search** D26/28-36;
362/459-468, 475-478, 485-487
See application file for complete search history.

FIG. 1 is a front elevational view of a rear combination lamp for a motor scooter showing our new design;
FIG. 2 is a top plan view thereof;
FIG. 3 is a bottom plan view thereof;
FIG. 4 is a right side elevational view thereof; and
FIG. 5 is a left side elevational view thereof;
FIG. 6 is a front perspective view thereof; and,
FIG. 7 is a rear perspective view thereof.

(56) **References Cited**

U.S. PATENT DOCUMENTS

D423,126 S	*	4/2000	Doss	D26/28
D462,467 S	*	9/2002	Nakazawa et al.	D26/28
D464,747 S	*	10/2002	Kokubu	D26/28
D498,012 S	*	11/2004	Ballentine	D26/28

1 Claim, 7 Drawing Sheets

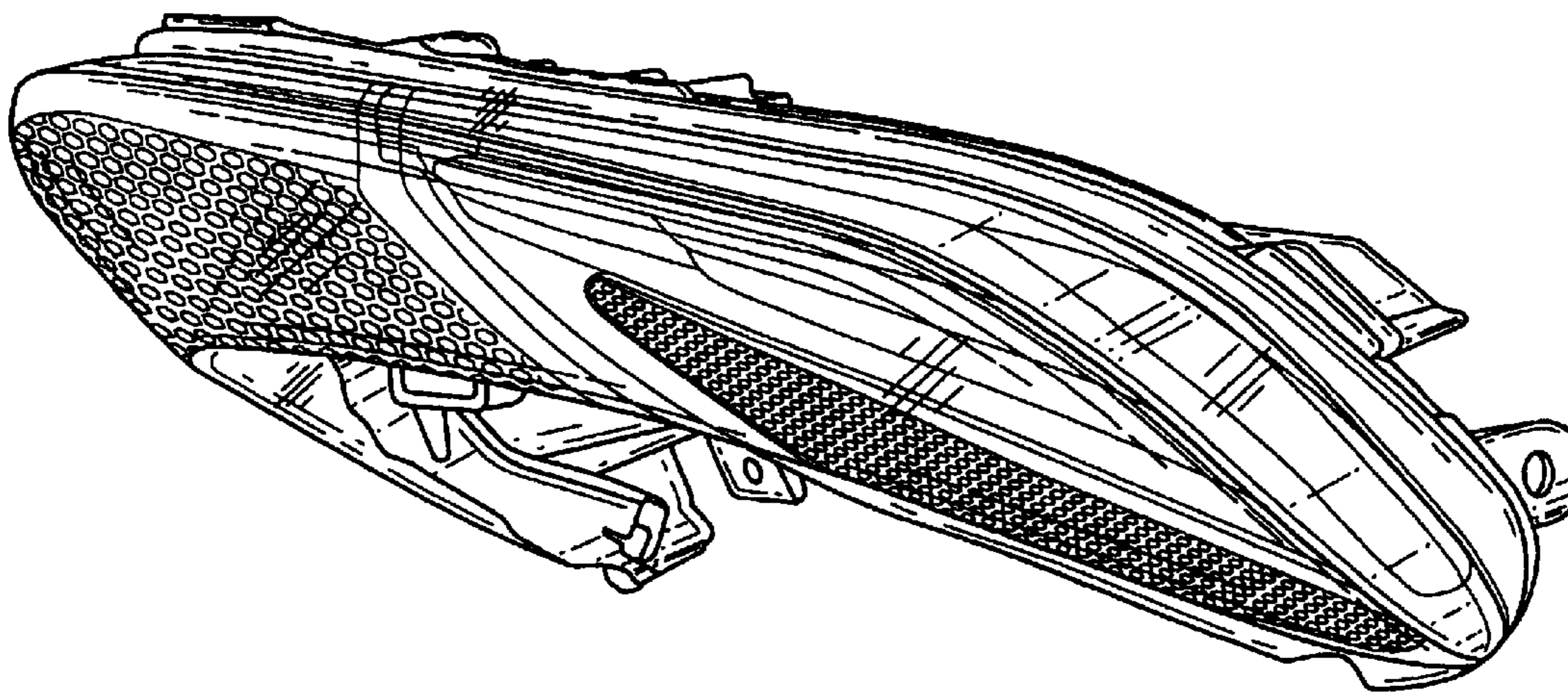

Fig.1

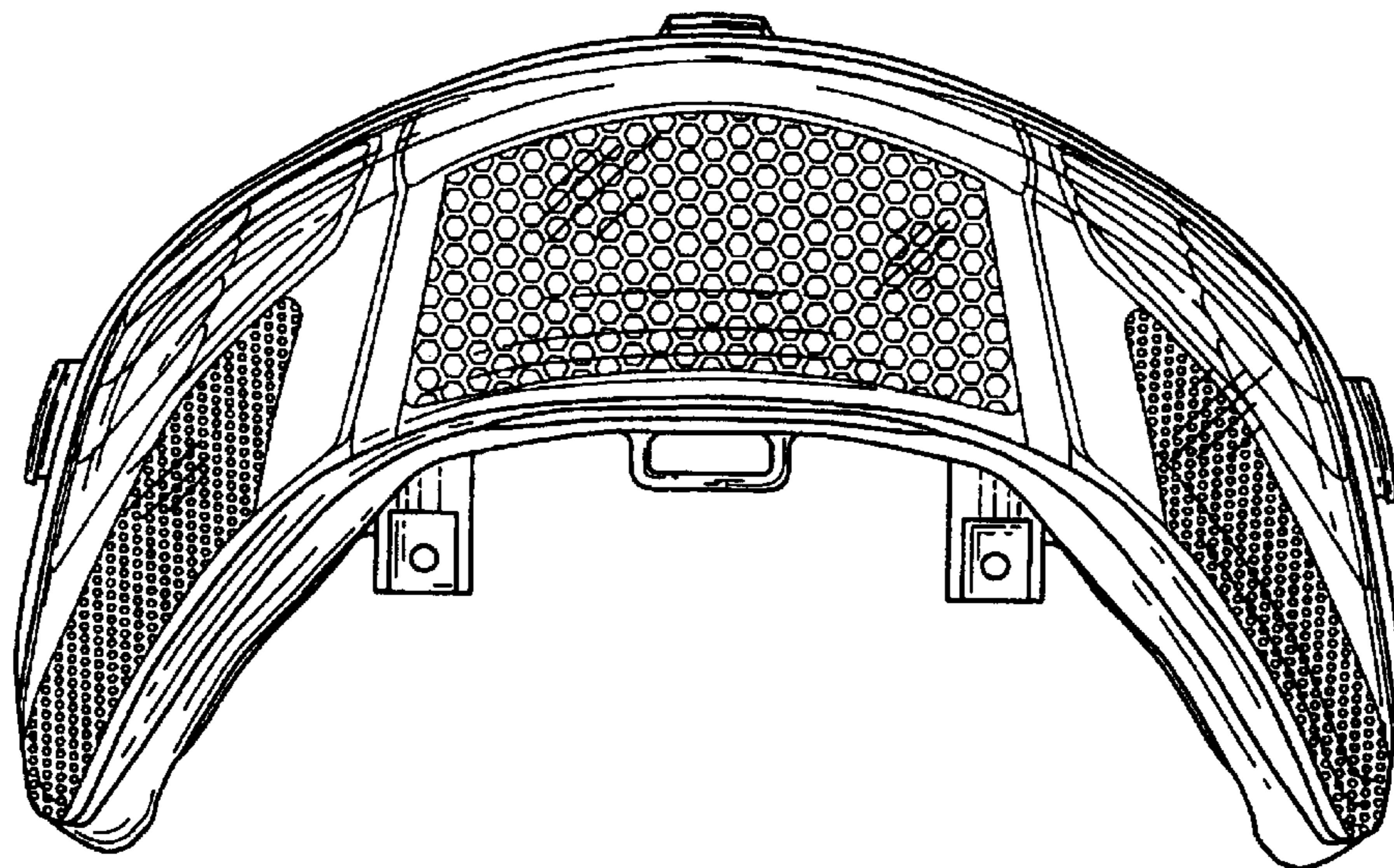

Fig.2

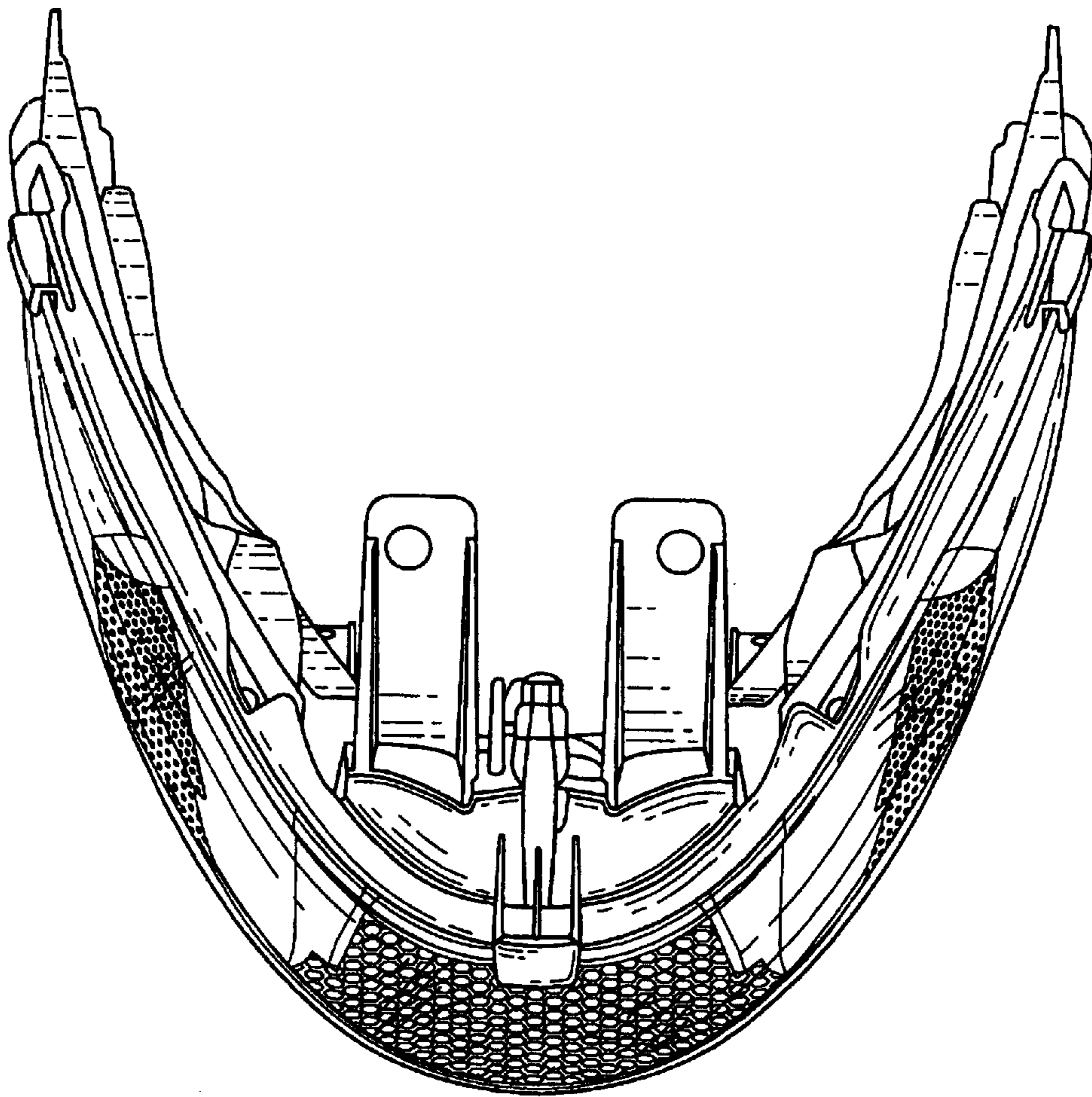

Fig.3

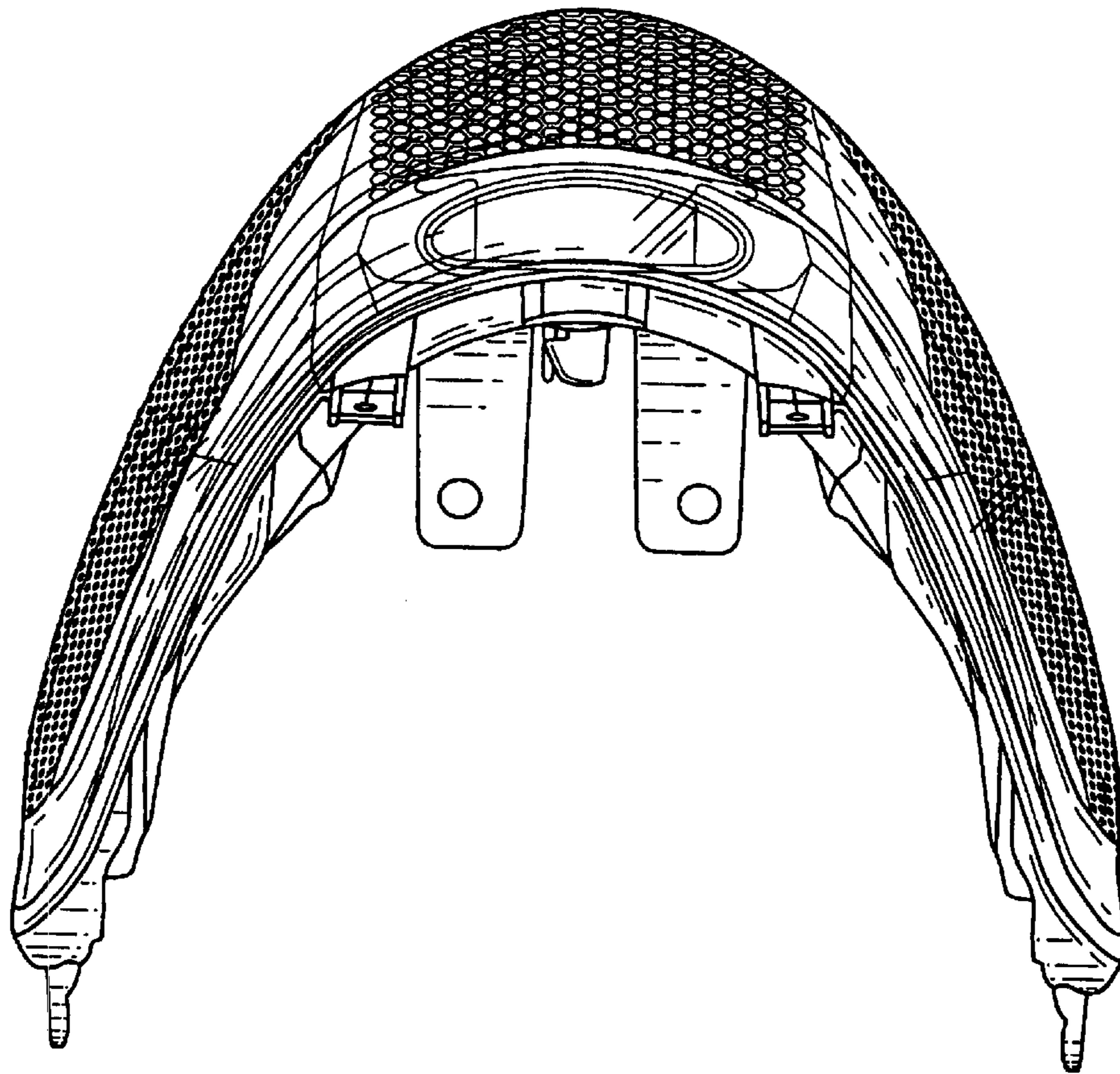

Fig.4

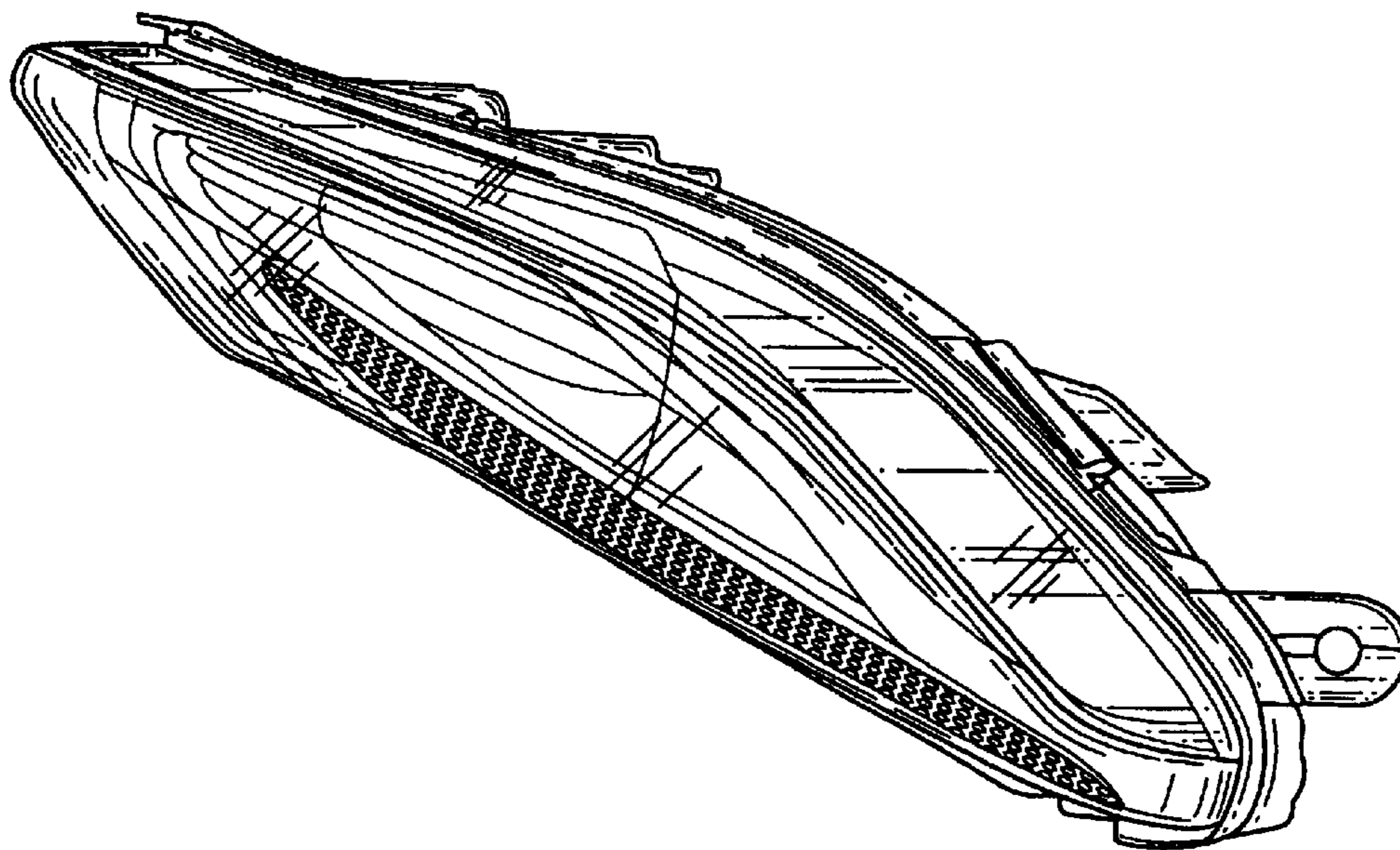

Fig.5

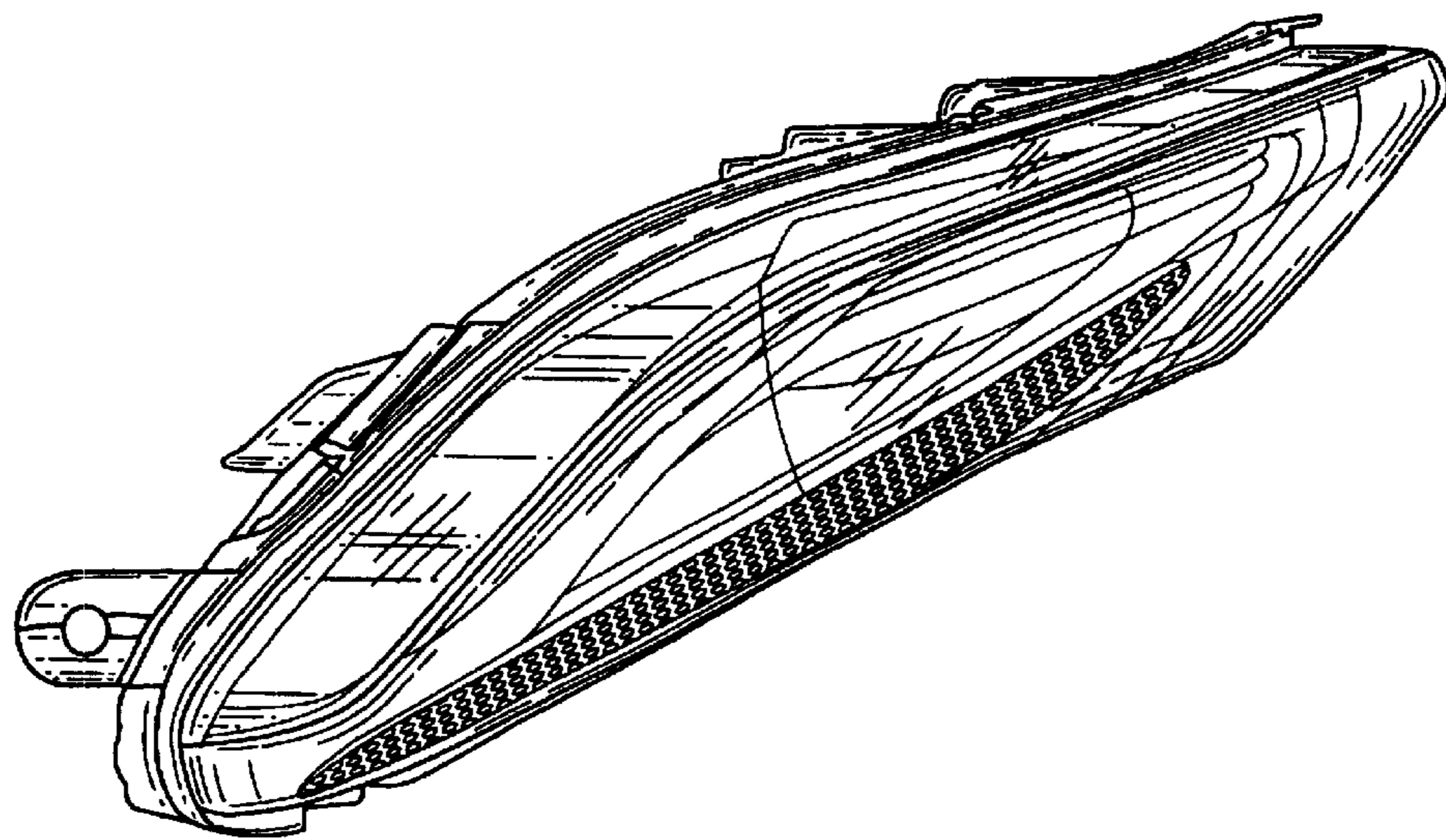

Fig.6

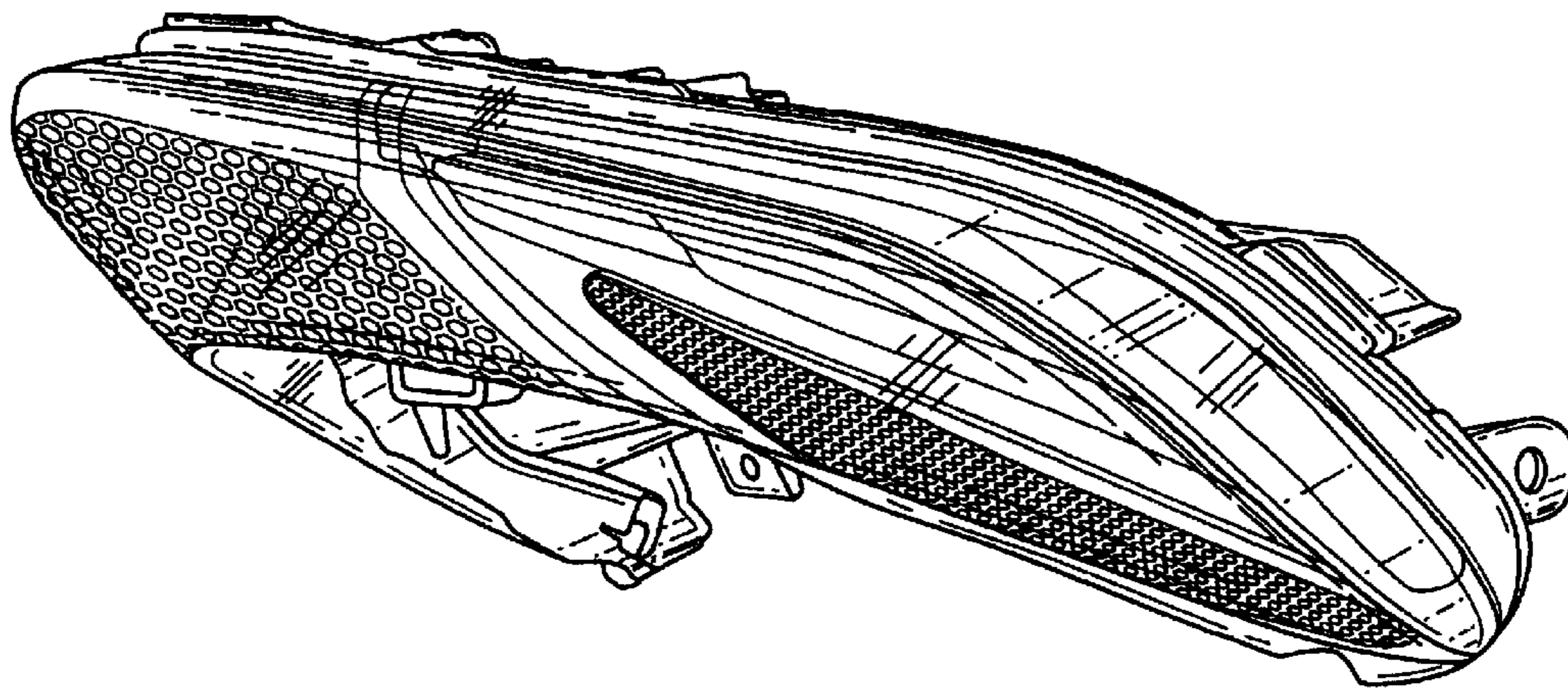

Fig.7

