



US00D552177S

(12) **United States Design Patent**
Cetera

(10) **Patent No.:** **US D552,177 S**

(45) **Date of Patent:** **** Oct. 2, 2007**

(54) **PEN CLIP**

(75) Inventor: **Carl Cetera**, Tenafly, NJ (US)

(73) Assignee: **Cotapaxi Custom Design and Manufacturing, LLC**, Carlstadt, NJ (US)

(**) Term: **14 Years**

(21) Appl. No.: **29/249,725**

(22) Filed: **Oct. 19, 2006**

Related U.S. Application Data

(62) Division of application No. 29/231,444, filed on Jun. 2, 2005, now Pat. No. Des. 536,035.

(51) **LOC (8) Cl.** **19-06**

(52) **U.S. Cl.** **D19/56**

(58) **Field of Classification Search** D19/35, D19/36, 41-51, 54-57; 24/11 R, 11 F, 11 P; 401/52, 99, 100, 104, 105, 106, 107, 108, 401/109, 192, 195, 196
See application file for complete search history.

(56) **References Cited**

U.S. PATENT DOCUMENTS

D366,498 S * 1/1996 Abe et al. D19/51
D395,448 S * 6/1998 Chevalier D19/51
D410,098 S * 5/1999 Chiu D26/38

6,280,110 B2 * 8/2001 Lin 401/106
D475,087 S * 5/2003 Stropkay et al. D19/56
D480,758 S * 10/2003 Keda D19/56
D493,835 S * 8/2004 Andrews et al. D19/56
D497,952 S * 11/2004 Bain D19/56
D501,030 S * 1/2005 Lecce D19/51
D529,089 S * 9/2006 Bhavnani D19/36

* cited by examiner

Primary Examiner—Elizabeth A. Albert

(74) *Attorney, Agent, or Firm*—The Soni Law Firm

(57) **CLAIM**

The ornamental design for a pen clip, as shown and described.

DESCRIPTION

FIG. 1 is a front side bottom perspective view of a pen clip showing my new design, with the phantom lines depicting environmental structure and forming no part of the claimed design;

FIG. 2 is a front elevational view thereof;

FIG. 3 is a right side elevational view thereof which is a mirror image of the left side thereof;

FIG. 4 is a bottom plan view thereof;

FIG. 5 is a back elevational view thereof; and,

FIG. 6 is a top plan view thereof.

1 Claim, 1 Drawing Sheet

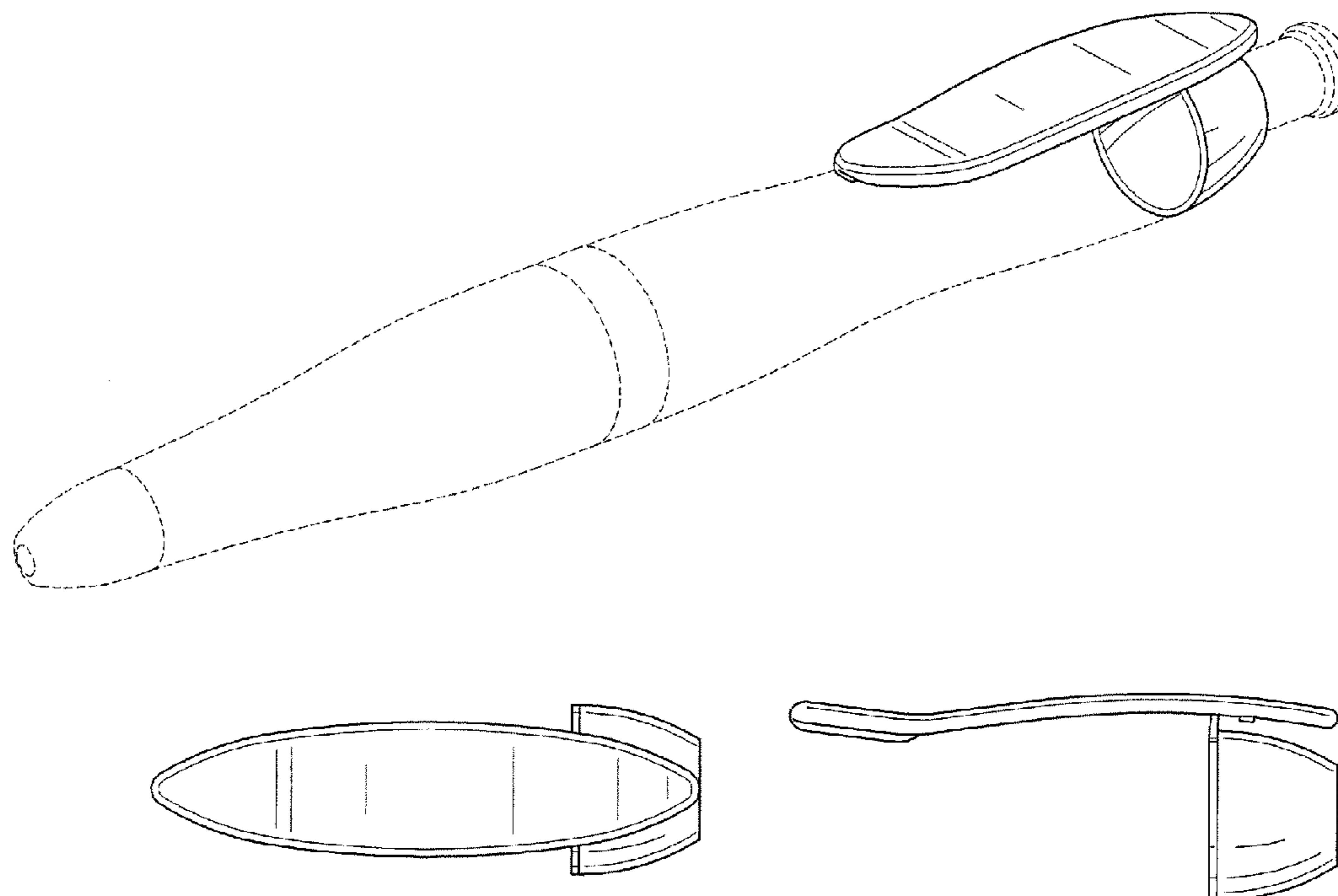

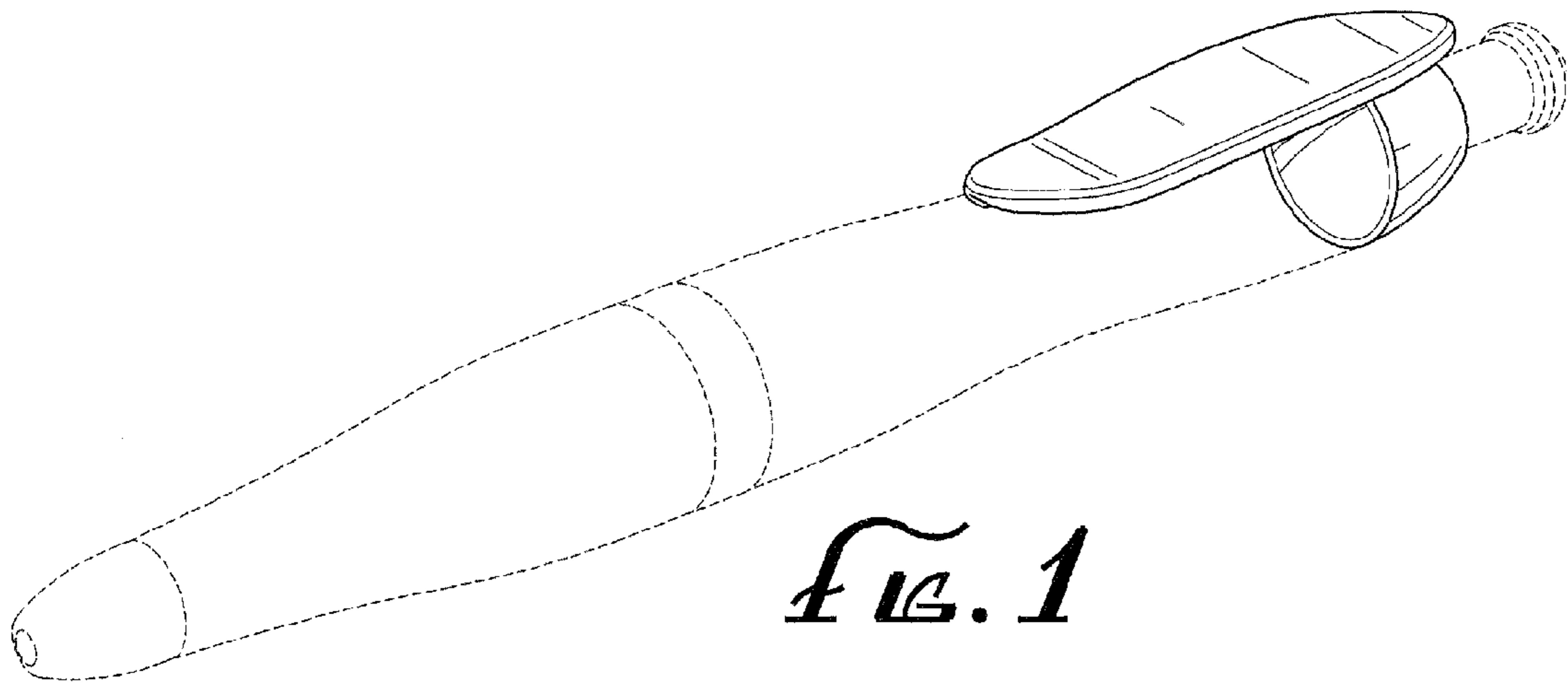

FIG. 1

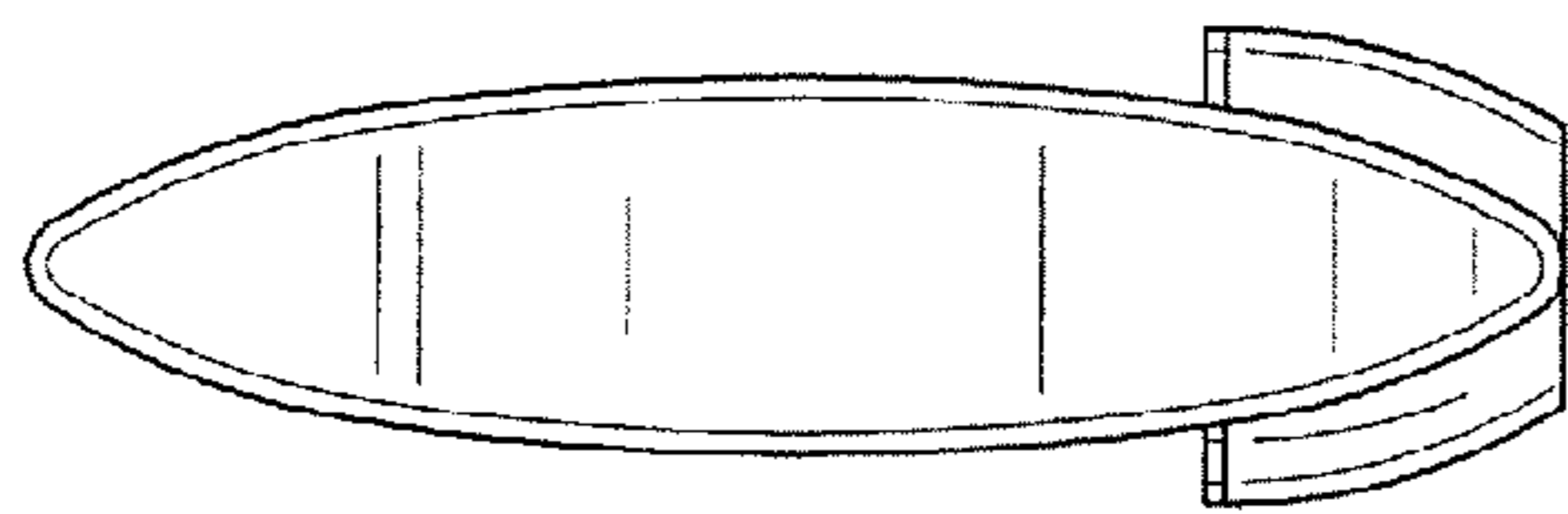

FIG. 2

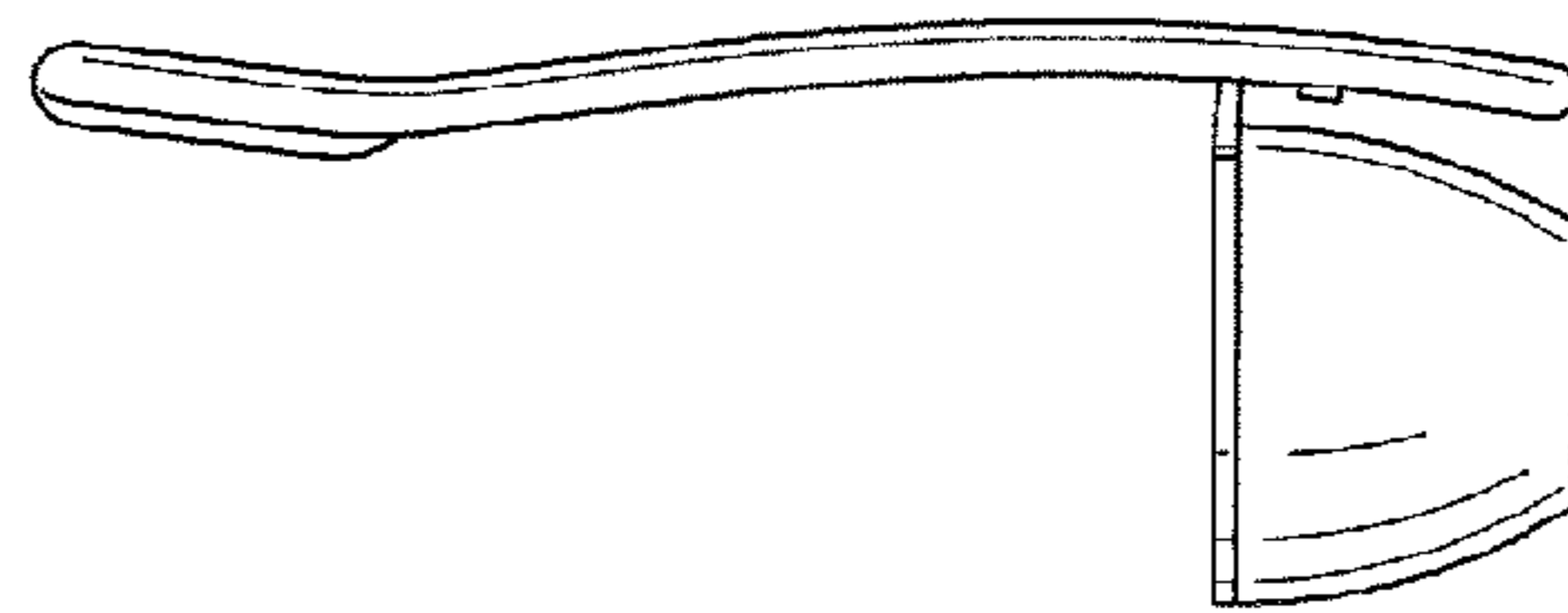

FIG. 3

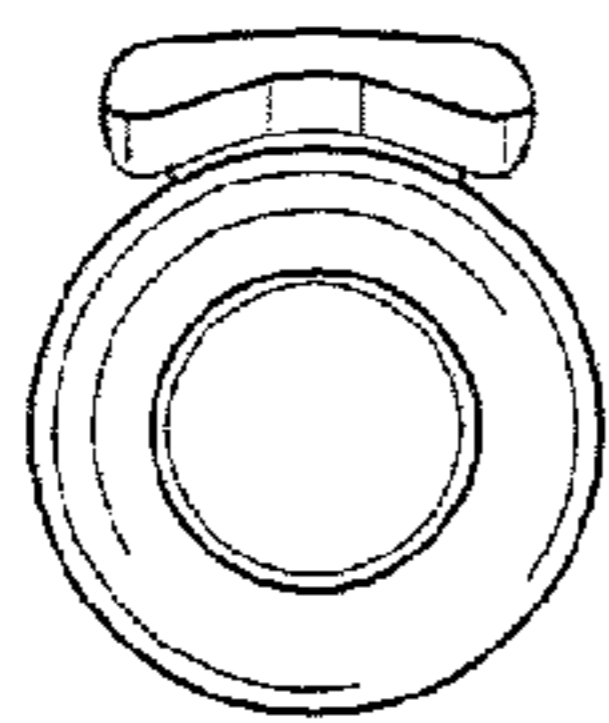

FIG. 4

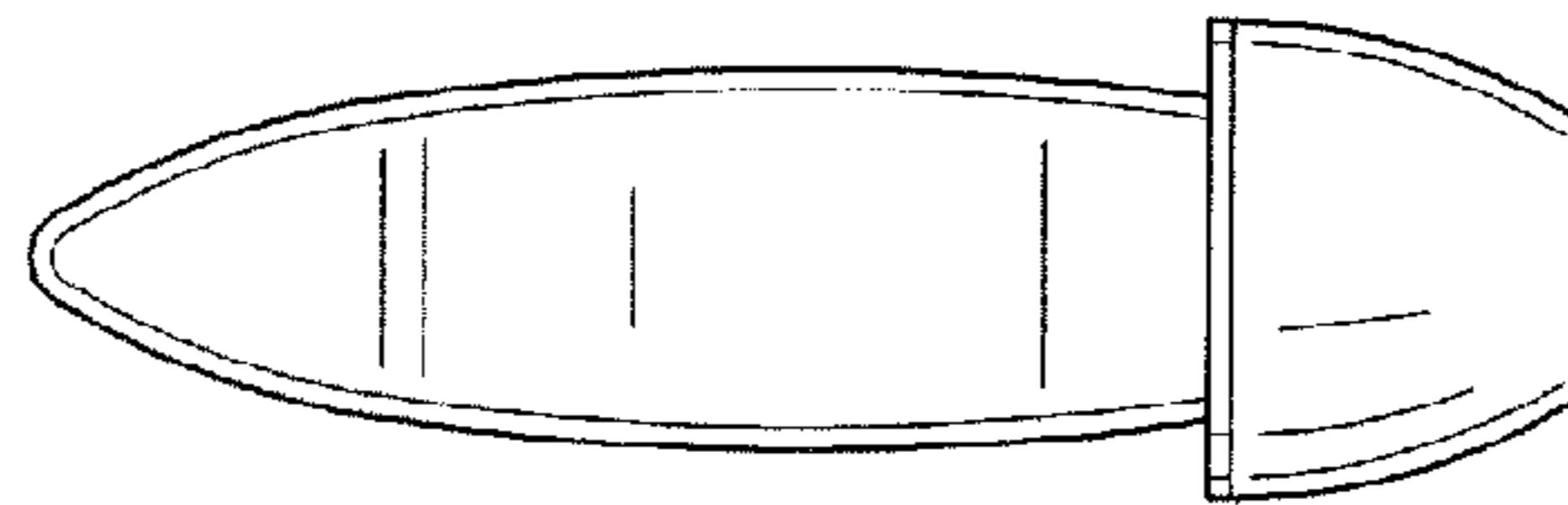

FIG. 5

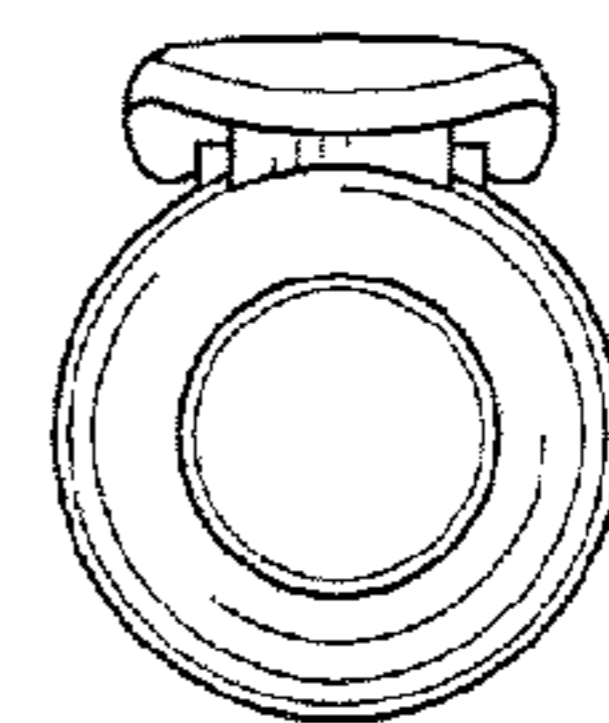

FIG. 6