



US00D552171S

(12) **United States Design Patent**
Motoki

(10) **Patent No.:** **US D552,171 S**

(45) **Date of Patent:** **** Oct. 2, 2007**

(54) **RIBBON CARTRIDGE FOR THERMAL-TRANSFER PRINTER**

(75) Inventor: **Zenko Motoki**, Fukushima-ken (JP)

(73) Assignee: **Alps Electric Co., Ltd.**, Tokyo (JP)

(**) Term: **14 Years**

(21) Appl. No.: **29/265,411**

(22) Filed: **Aug. 30, 2006**

(30) **Foreign Application Priority Data**

Jun. 8, 2006 (JP) 2006-014801

(51) **LOC (8) Cl.** **18-02**

(52) **U.S. Cl.** **D18/56; 347/86**

(58) **Field of Classification Search** D18/12,
D18/40, 43, 56; D14/471, 481, 483; 347/178,
347/214; 399/110; 400/193, 196, 196.1,
400/207-208, 208.1, 240.4, 242, 613
See application file for complete search history.

(56) **References Cited**

U.S. PATENT DOCUMENTS

4,978,240 A * 12/1990 Katsuno 347/214
D332,275 S * 1/1993 Katsuno D18/56

D446,239 S * 8/2001 Funaki D18/12
6,962,451 B2 * 11/2005 Narita et al. 400/207
D514,153 S * 1/2006 Tu D18/12
D523,891 S * 6/2006 Tu D18/12
2005/0052523 A1 * 3/2005 Kaida et al. 347/214

* cited by examiner

Primary Examiner—Cathy Anne MacCormac

(74) *Attorney, Agent, or Firm*—Brinks Hofer Gilson & Lione

(57) **CLAIM**

The ornamental design for a ribbon cartridge for a thermal-transfer printer, as shown and described.

DESCRIPTION

FIG. 1 is a front view of a ribbon cartridge for a thermal-transfer printer;

FIG. 2 is a rear view thereof;

FIG. 3 is a right side view thereof;

FIG. 4 is a left side view thereof;

FIG. 5 is a top view thereof;

FIG. 6 is a bottom view thereof; and,

FIG. 7 is a top perspective view thereof.

1 Claim, 4 Drawing Sheets

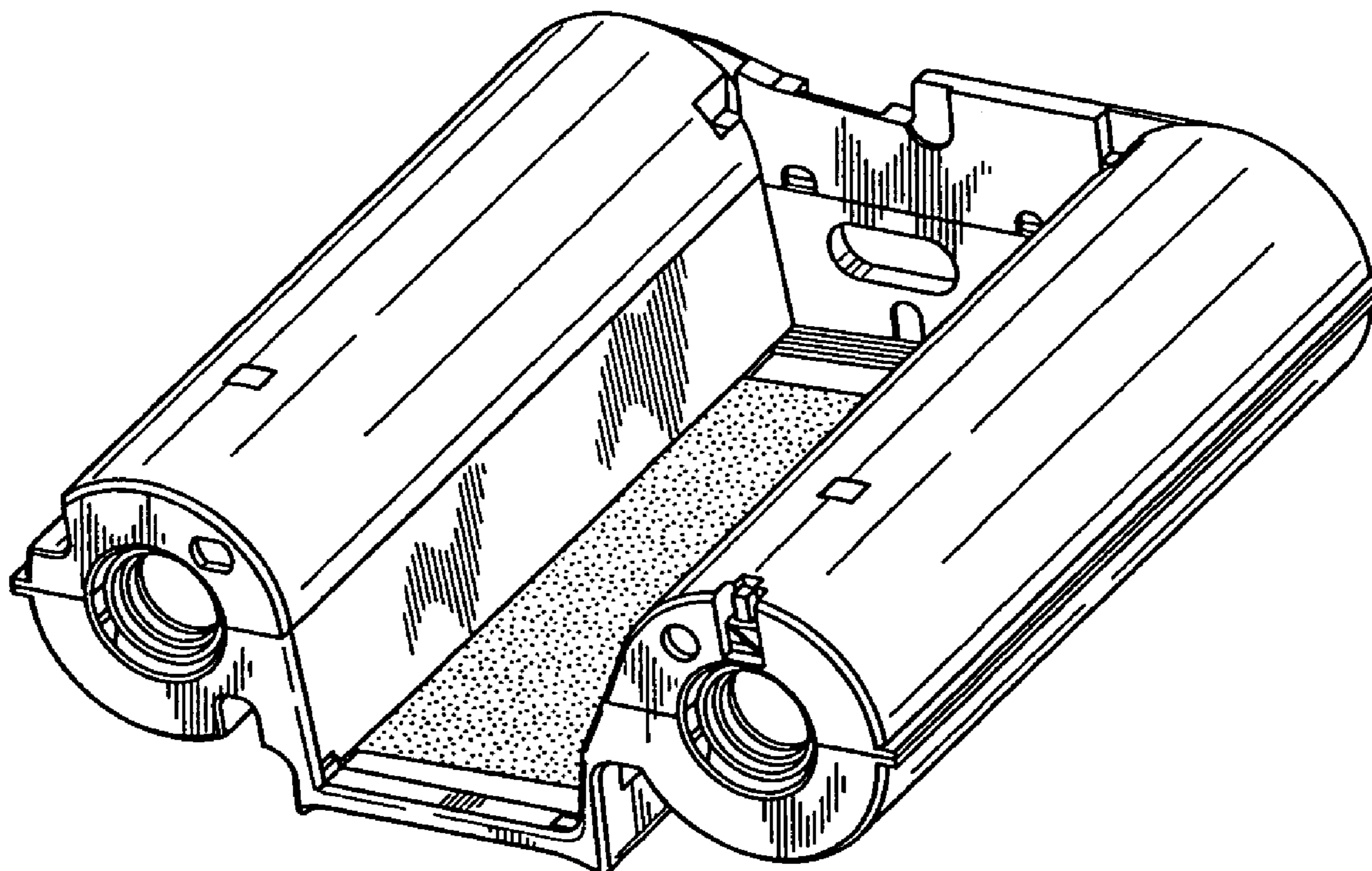

FIG. 1

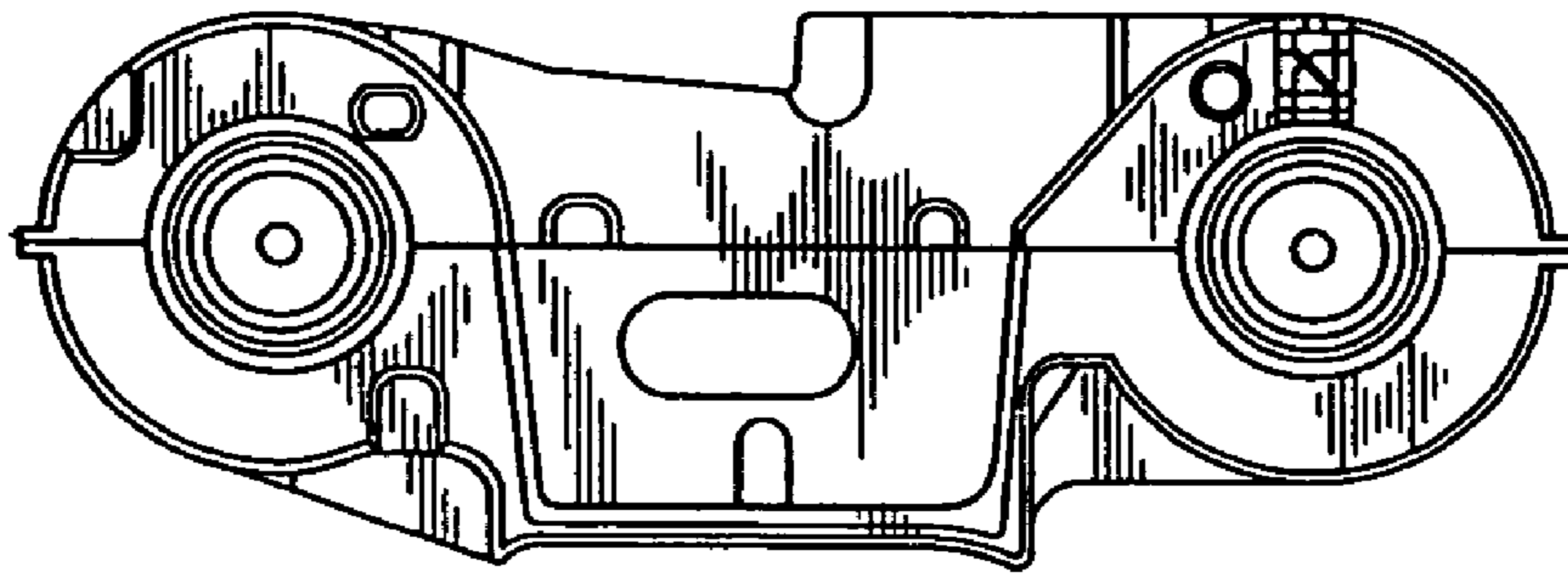

FIG. 2

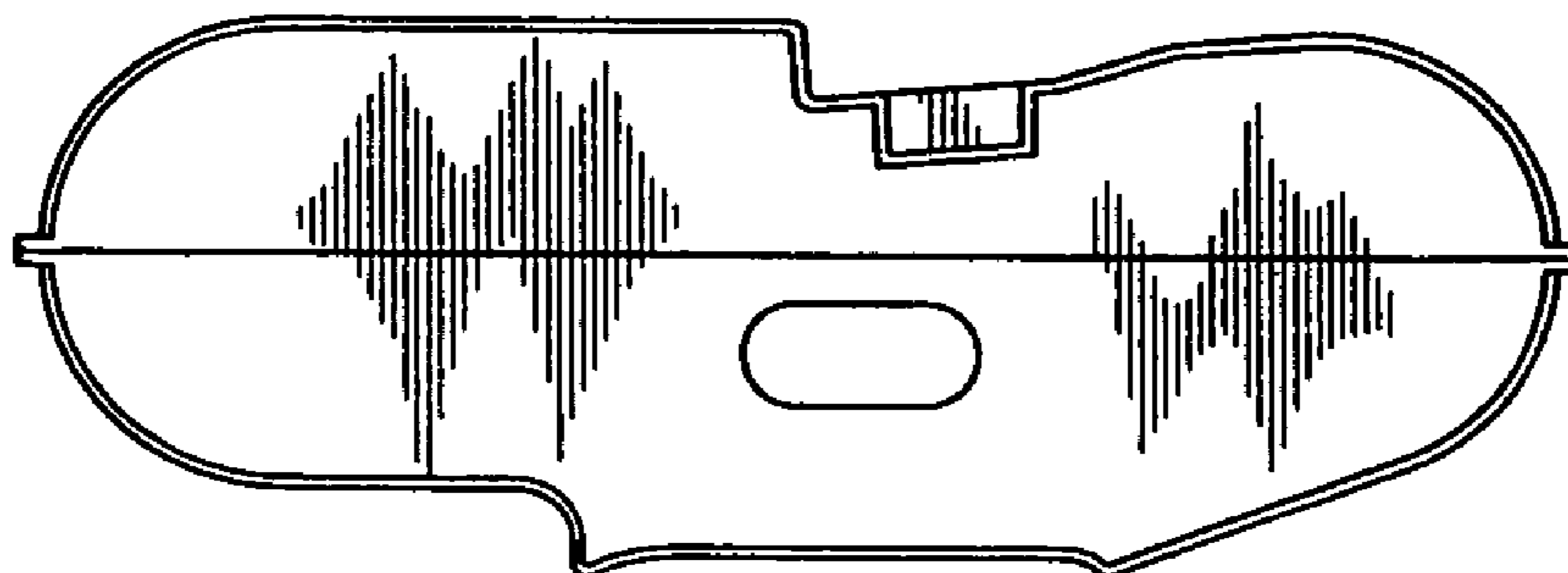

FIG. 3

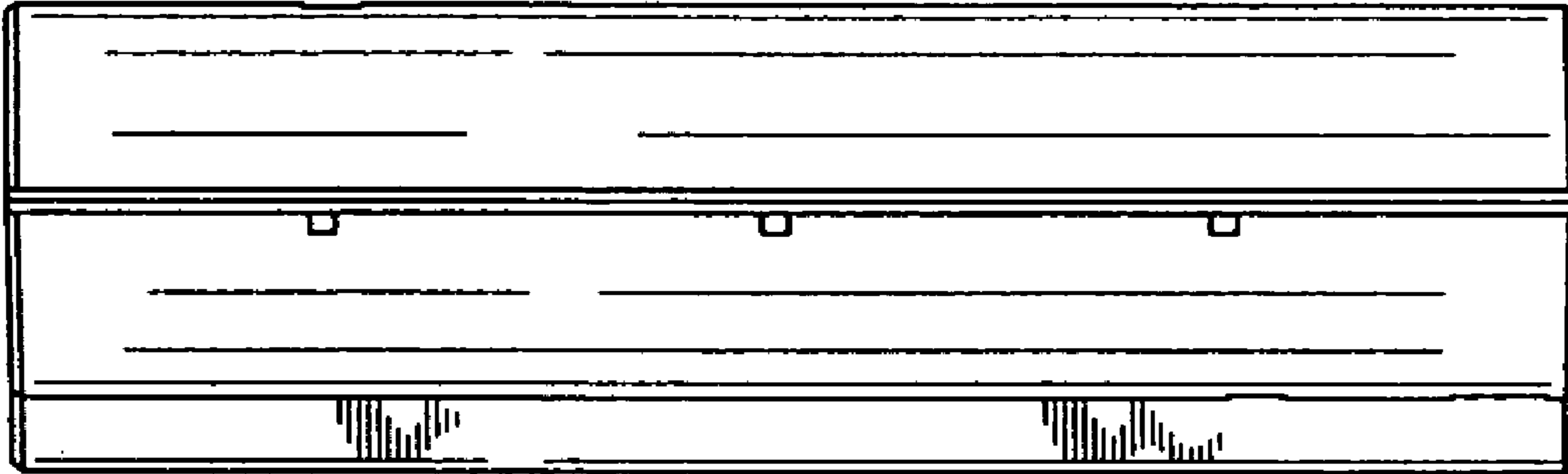

FIG. 4

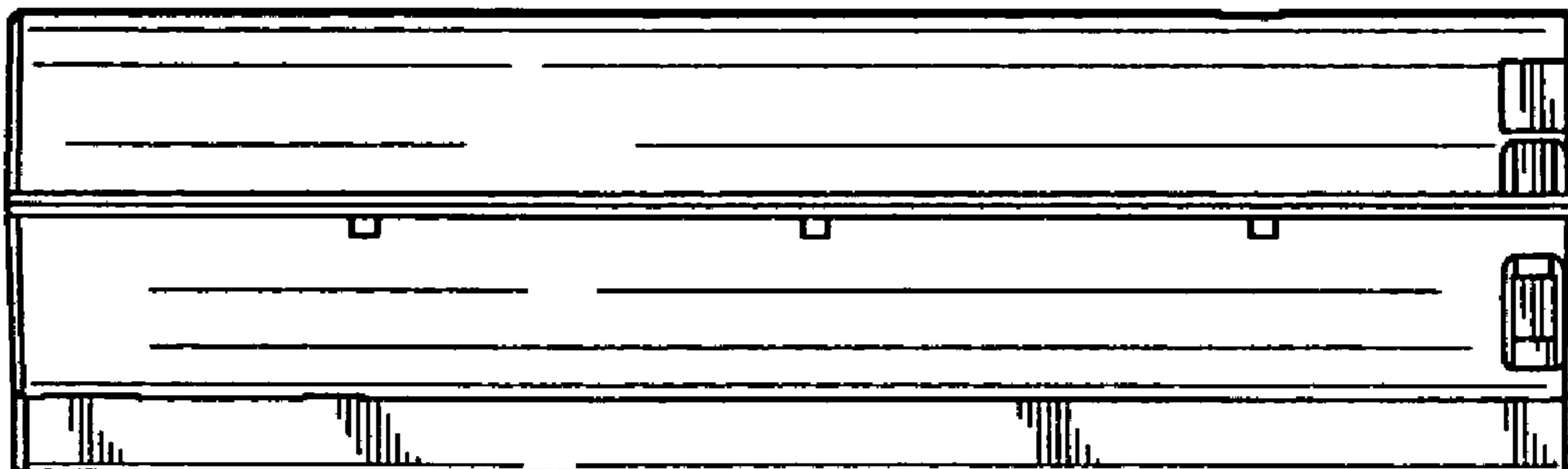

FIG. 5

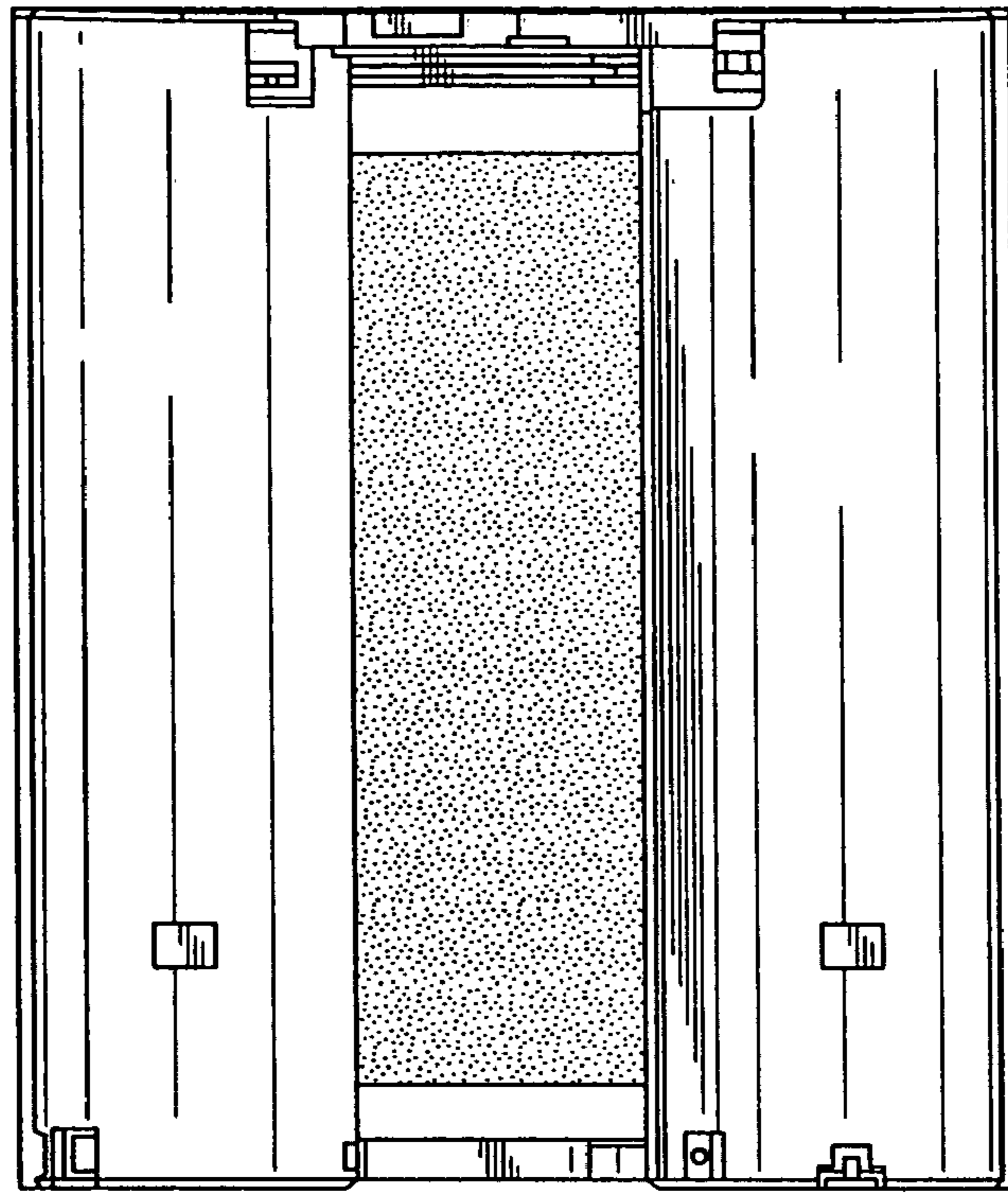

FIG. 6

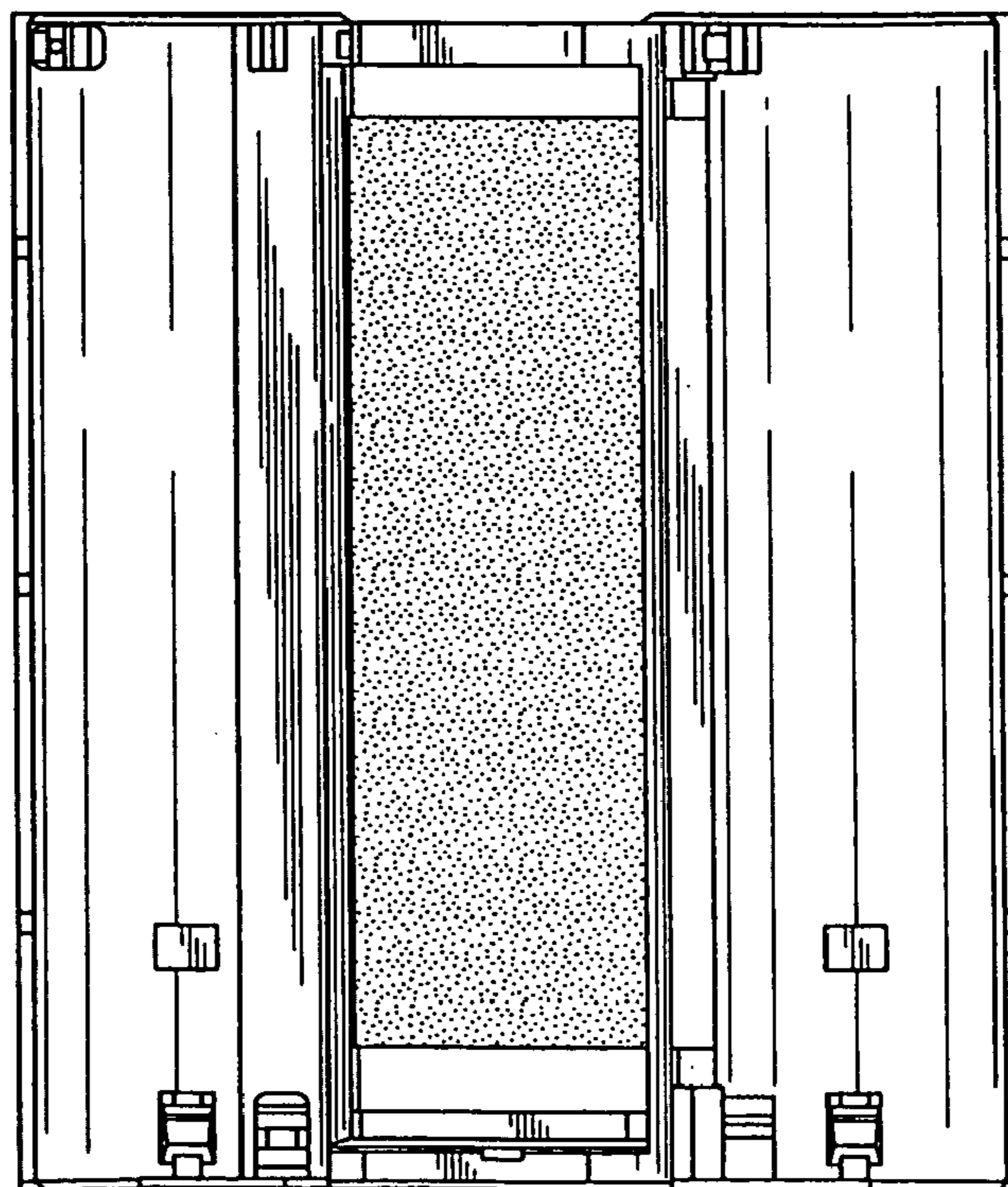

FIG. 7

