



US00D552142S

(12) **United States Design Patent**
Chung

(10) **Patent No.:** **US D552,142 S**

(45) **Date of Patent:** **** Oct. 2, 2007**

(54) **CAMCORDER**

(75) **Inventor:** **Yeon-Moo Chung**, Seoul (KR)

(73) **Assignee:** **Samsung Electronics Co., Ltd.**,
Kyunggi-do (KR)

(**) **Term:** **14 Years**

(21) **Appl. No.:** **29/251,086**

(22) **Filed:** **Jan. 4, 2006**

(51) **LOC (8) Cl.** **16-01**

(52) **U.S. Cl.** **D16/202; D16/205**

(58) **Field of Classification Search** **D16/200–205,**
D16/208, 218; 348/373–376; 358/906,
358/909.1; 396/535–541

See application file for complete search history.

(56) **References Cited**

U.S. PATENT DOCUMENTS

D356,806 S	3/1995	Kim	
D365,354 S	12/1995	Sung	
D366,886 S	2/1996	Choi	
D368,729 S	4/1996	Choi	
D372,925 S	8/1996	Choi	
D378,296 S	3/1997	Choi	
D383,767 S	9/1997	Sung et al.	
D386,506 S	11/1997	Choi	
D390,243 S	2/1998	Choi	
D396,051 S *	7/1998	Mori	D16/202
D407,097 S *	3/1999	Suzuki et al.	D16/205
D446,800 S *	8/2001	Fukushima et al.	D16/202
D450,736 S *	11/2001	Shinano	D16/202
D474,792 S	5/2003	Hyun	
D484,901 S	1/2004	Lim	
6,727,954 B1 *	4/2004	Kondo et al.	348/374
D499,437 S *	12/2004	Miyamori et al.	D16/202
D502,720 S *	3/2005	Egnoto et al.	D16/202
D503,731 S *	4/2005	Kinemura et al.	D16/202

D515,605 S *	2/2006	Hayashi et al.	D16/202
D520,044 S *	5/2006	Chung et al.	D16/202
D520,545 S *	5/2006	Chung et al.	D16/202
D520,546 S *	5/2006	Kim	D16/202
D521,041 S *	5/2006	Chung et al.	D16/202
D526,674 S *	8/2006	Byun et al.	D16/202
D528,142 S *	9/2006	Byun et al.	D16/202
D528,575 S *	9/2006	Suzuki et al.	D16/202
D528,576 S *	9/2006	Chung et al.	D16/202
D528,577 S *	9/2006	Byun et al.	D16/202

FOREIGN PATENT DOCUMENTS

JP 1095991 * 1/2001

* cited by examiner

Primary Examiner—Adir Aronovich

(74) *Attorney, Agent, or Firm*—Flynn, Thiel, Boutell & Tanis, P.C.

(57) **CLAIM**

The ornamental design for a camcorder, as shown and described.

DESCRIPTION

FIG. 1 is a top front perspective view of a camcorder showing our new design;

FIG. 2 is a front elevational view thereof;

FIG. 3 is a rear elevational view thereof;

FIG. 4 is a left side elevational view thereof;

FIG. 5 is a right side elevational view thereof;

FIG. 6 is a top plan view thereof;

FIG. 7 is a bottom plan view thereof; and,

FIG. 8 is a top, front perspective view thereof, the camcorder shown in an operational position.

1 Claim, 5 Drawing Sheets

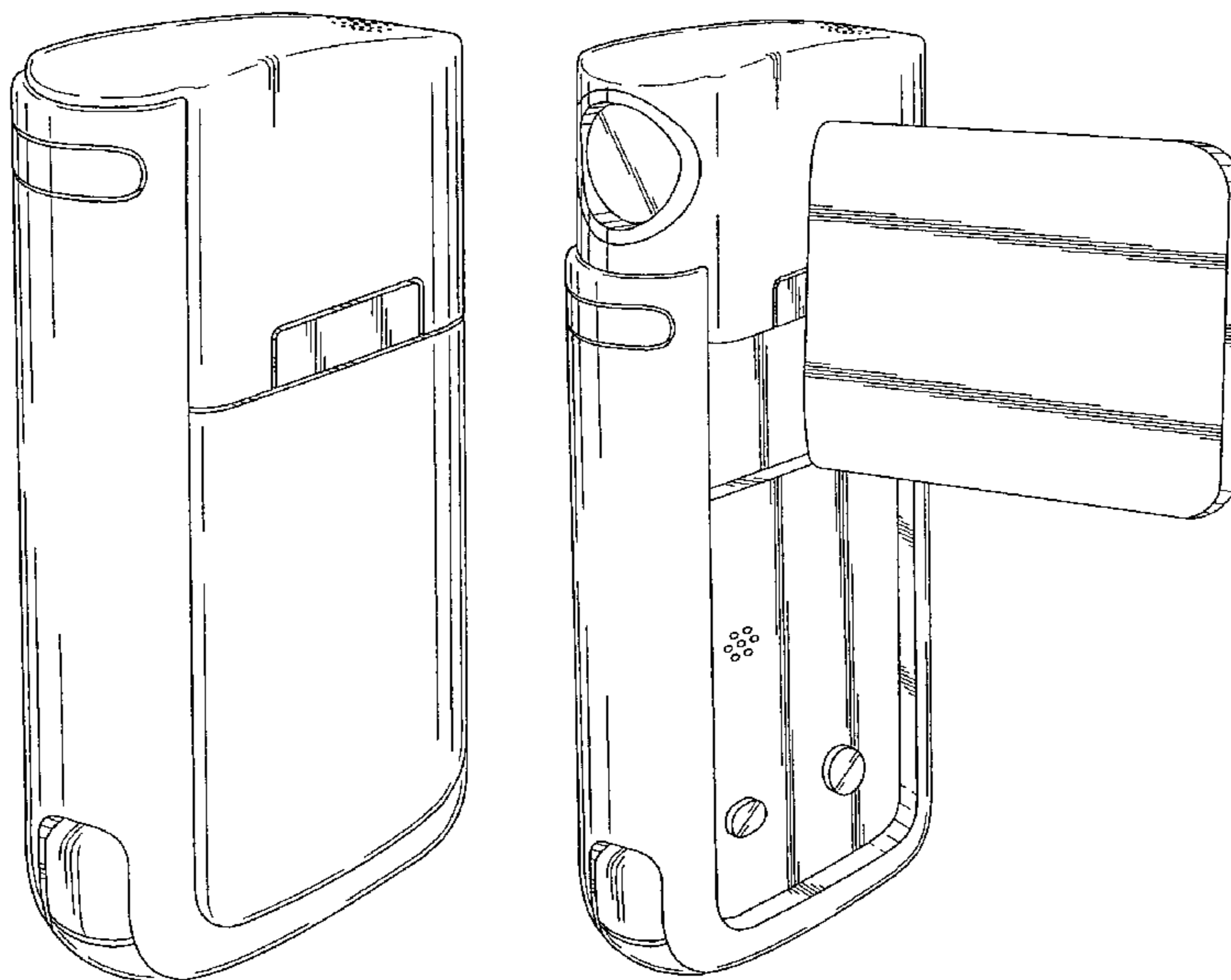

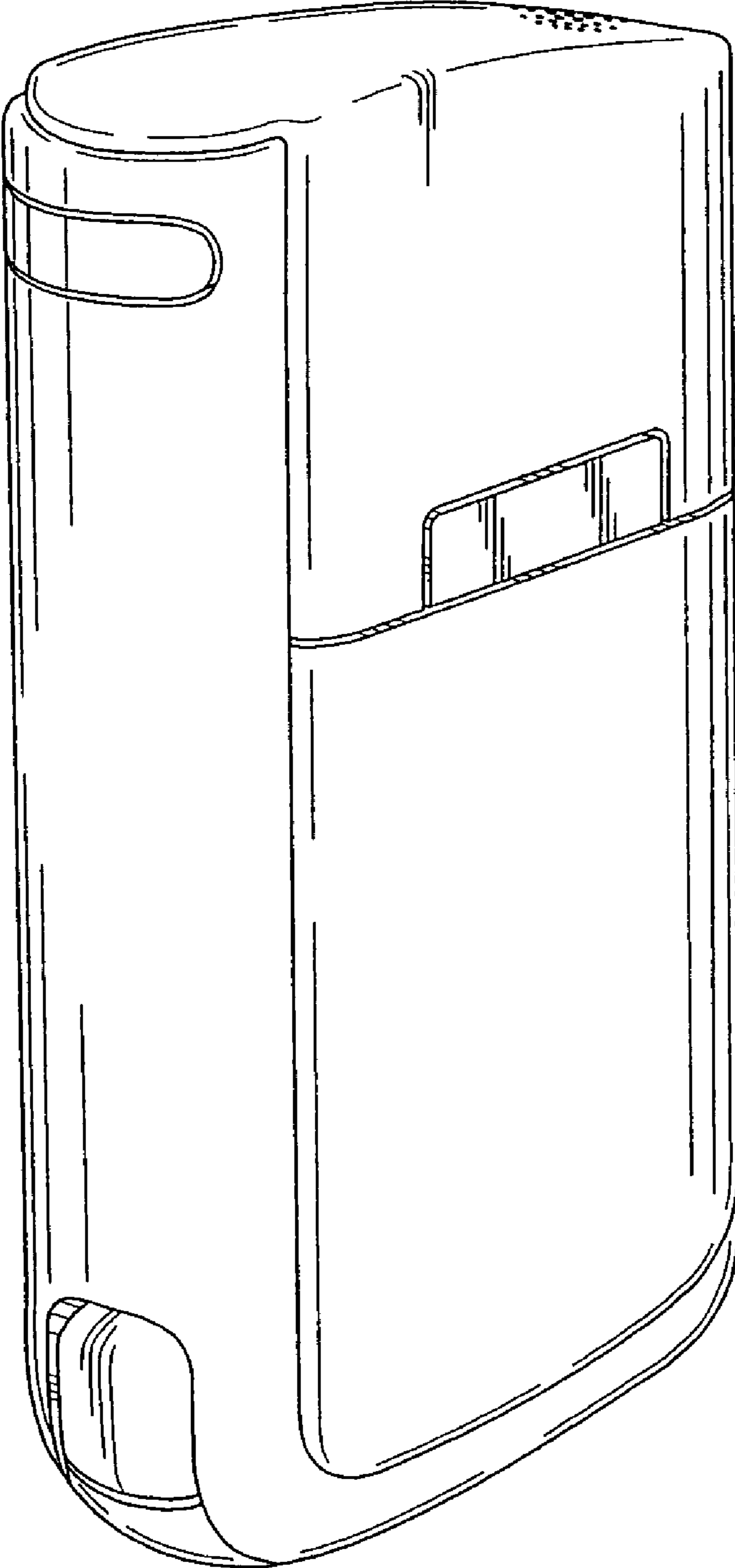

FIG. 1

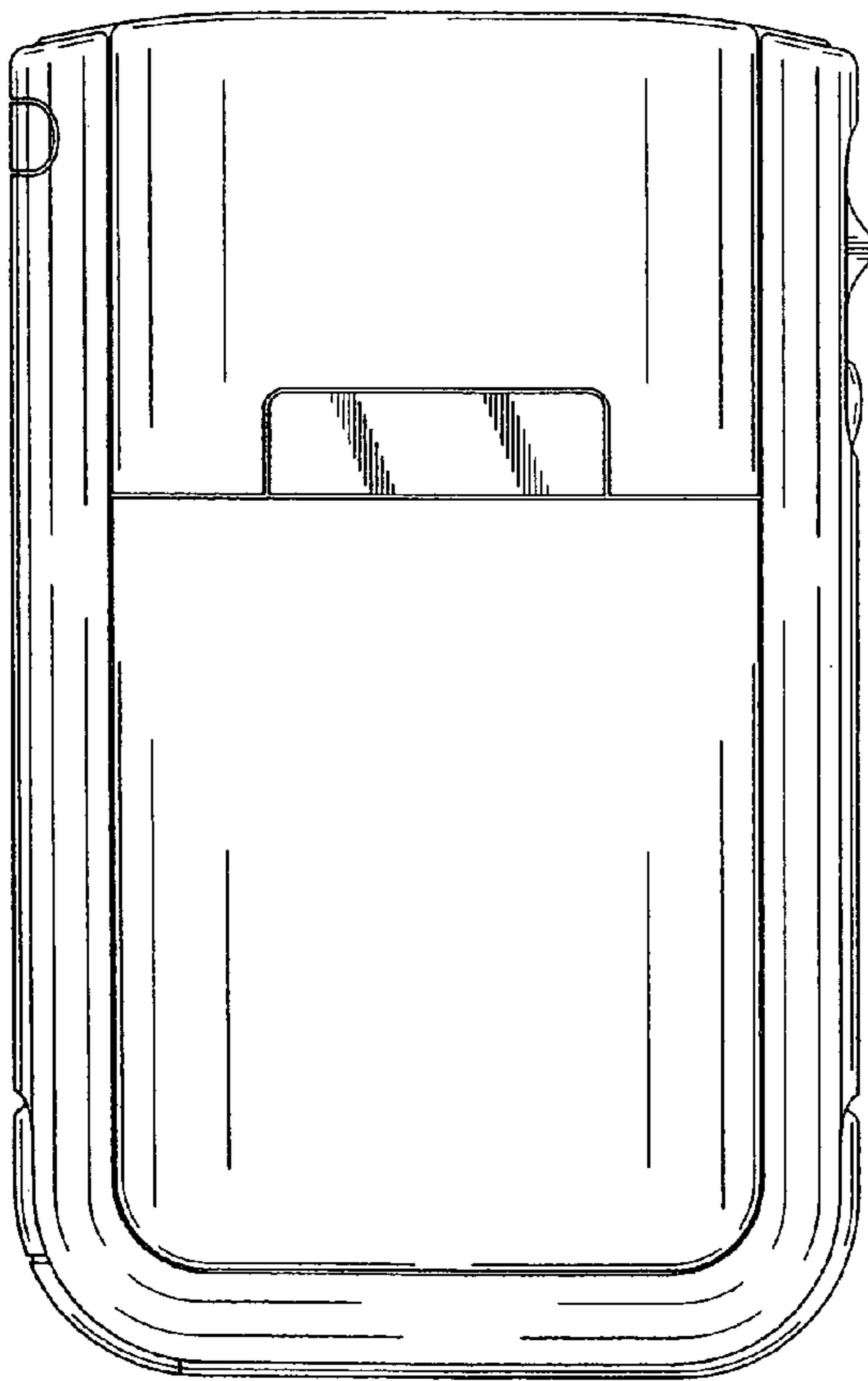

FIG. 2

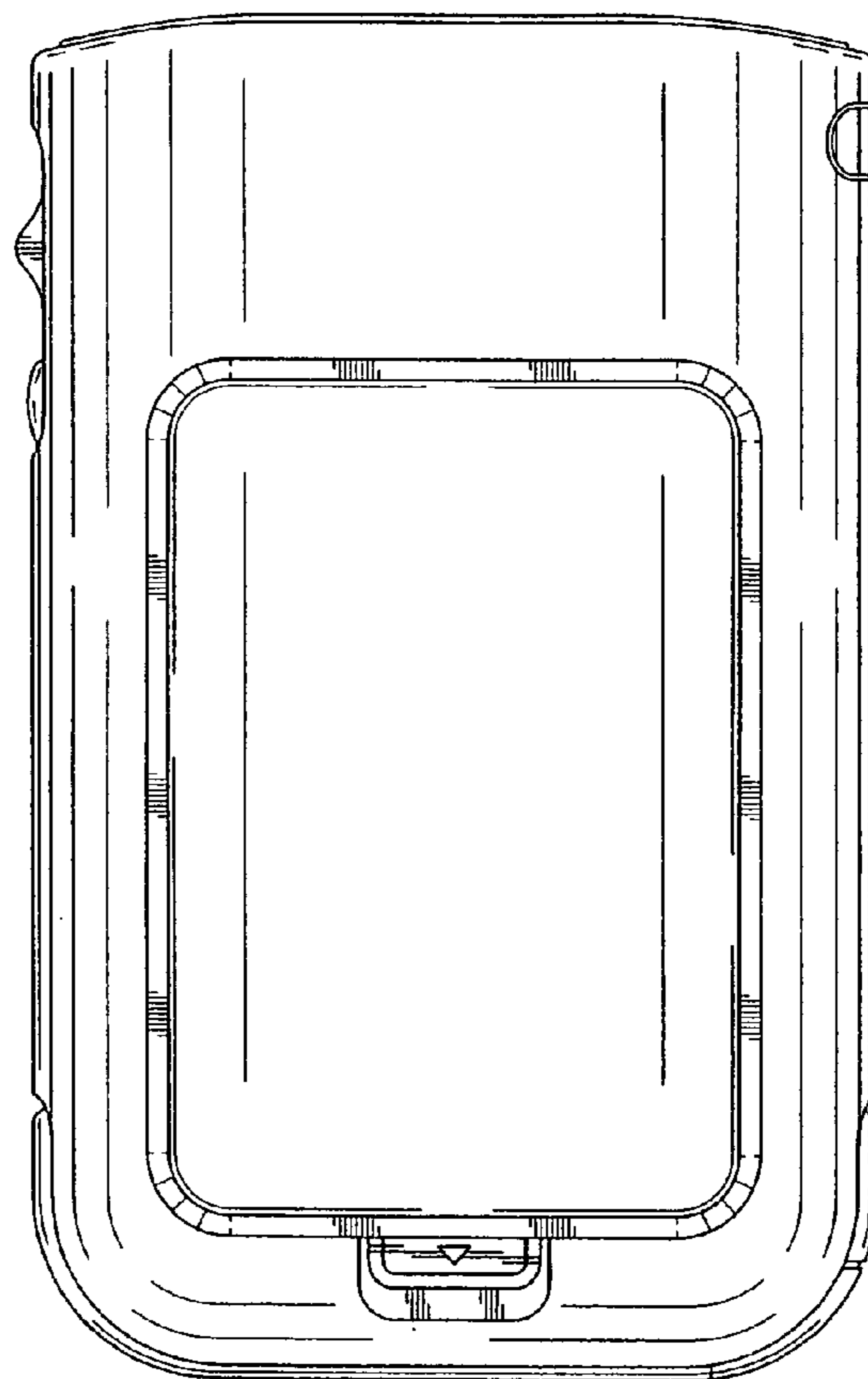

FIG. 3

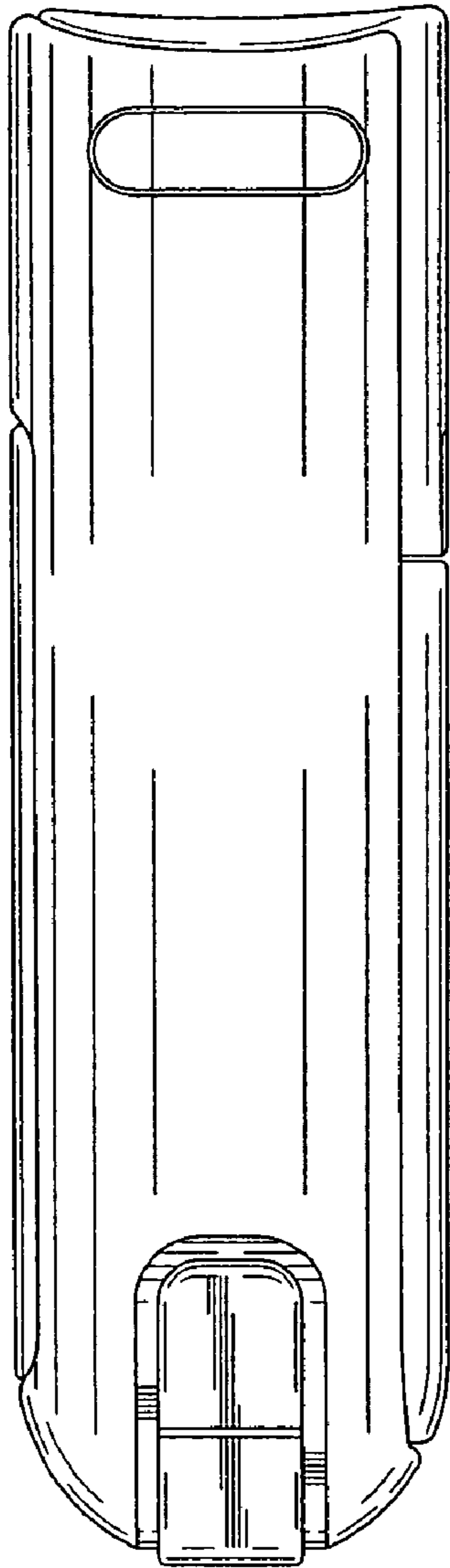

FIG. 4

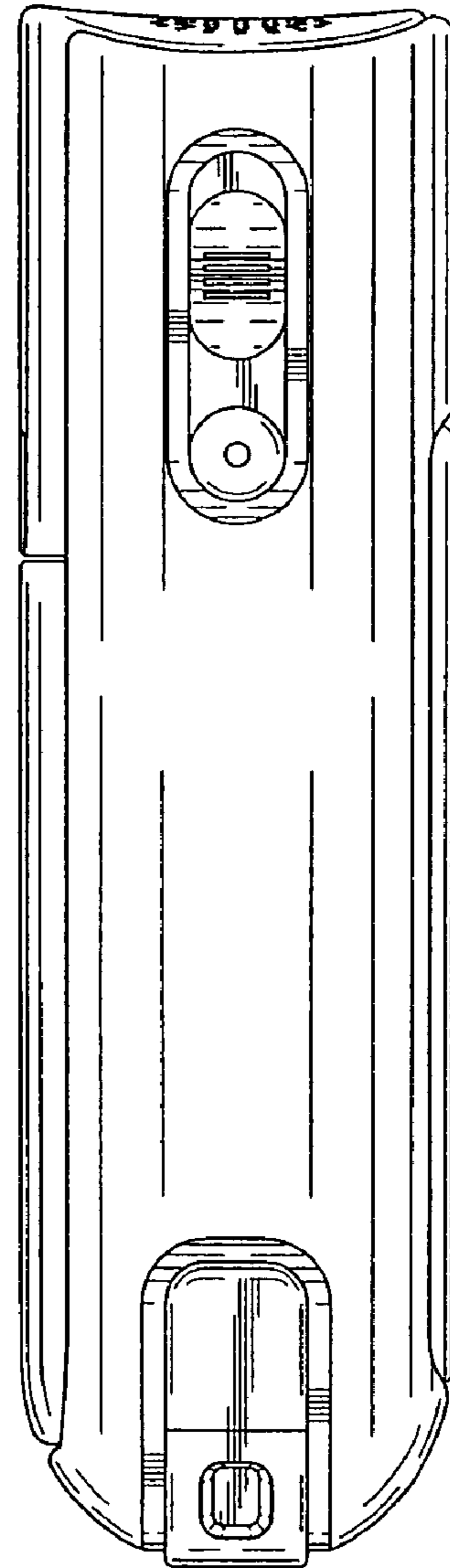

FIG. 5

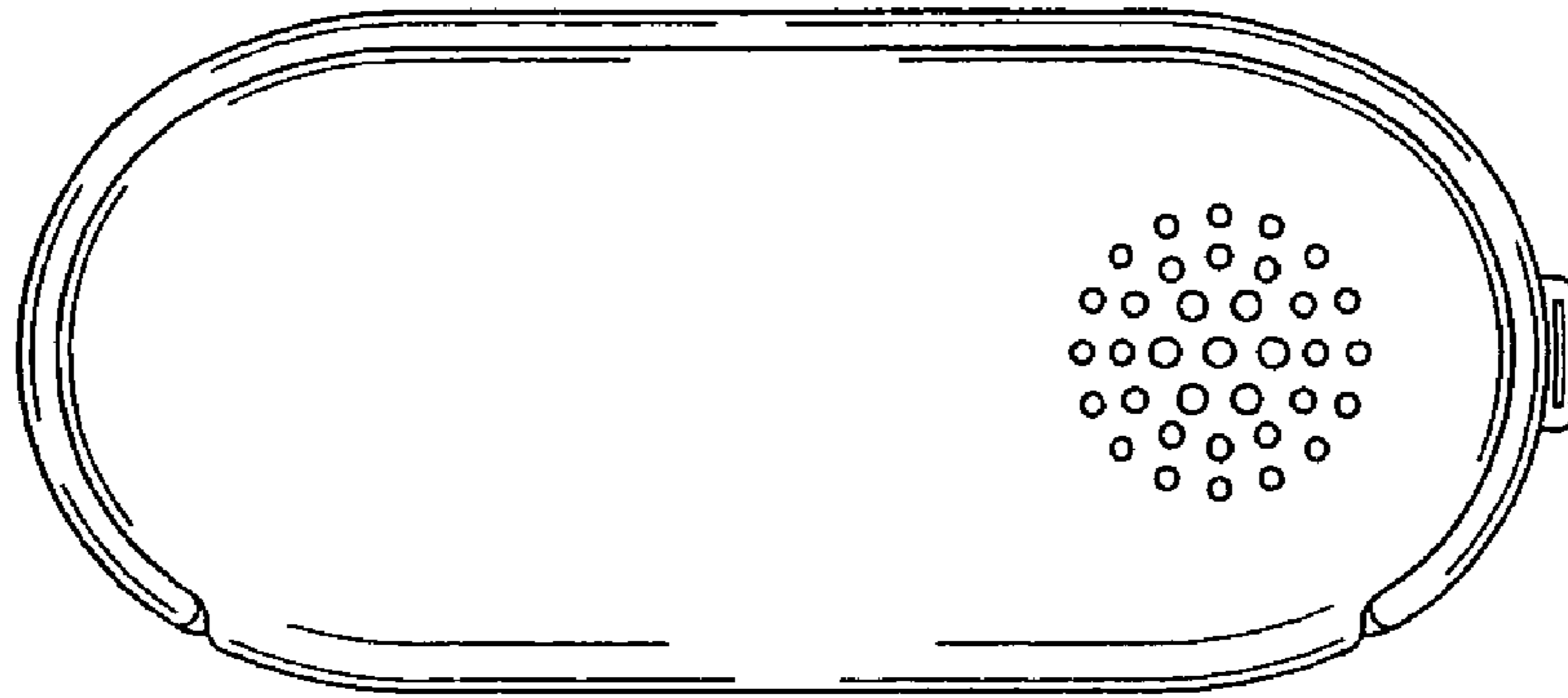

FIG. 6

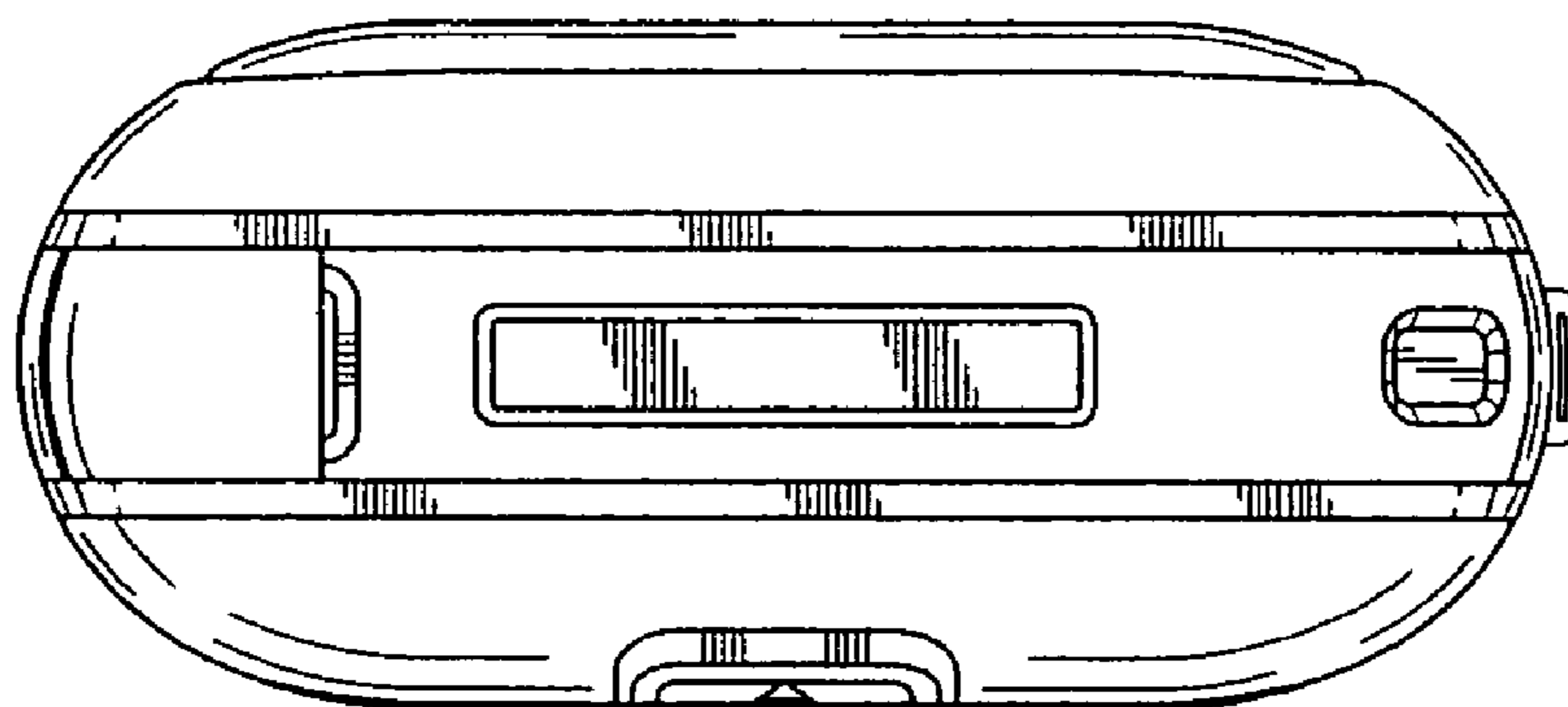

FIG. 7

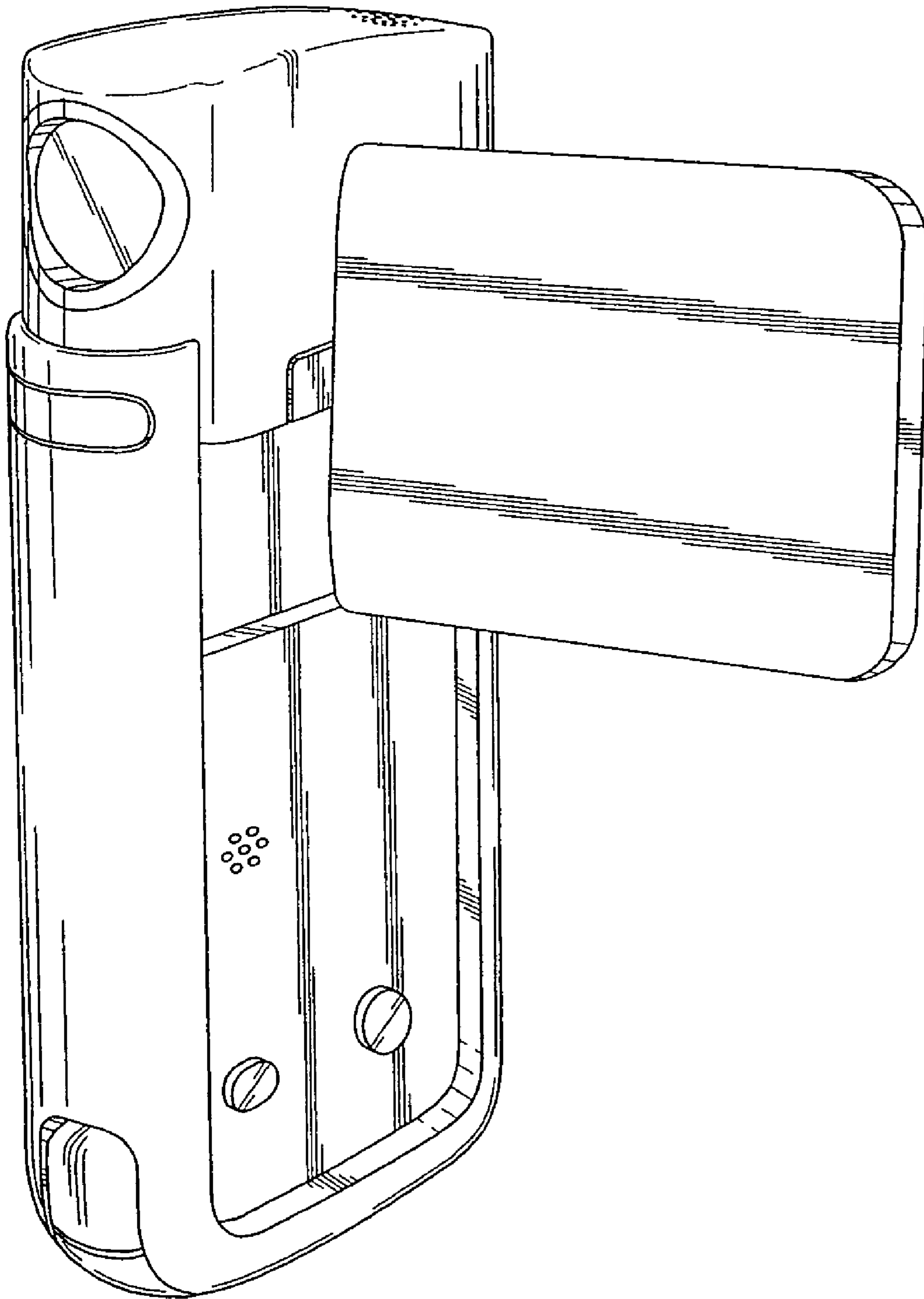

FIG. 8