



US00D552141S

(12) **United States Design Patent**  
**Kaplan et al.**

(10) **Patent No.:** **US D552,141 S**

(45) **Date of Patent:** **\*\* Oct. 2, 2007**

(54) **DIGITAL VIDEO RECORDER DEVICE**

(75) Inventors: **Jonathan Kaplan**, San Francisco, CA (US); **Ariel Braunstein**, San Francisco, CA (US); **Simon Flemingwood**, Oakland, CA (US); **John Furlan**, Belmont, CA (US); **Robert Evans**, San Francisco, CA (US)

(73) Assignee: **Pure Digital Technologies, Inc.**, San Francisco, CA (US)

(\*\*) Term: **14 Years**

(21) Appl. No.: **29/242,792**

(22) Filed: **Nov. 14, 2005**

(51) **LOC (8) Cl.** ..... **16-01**

(52) **U.S. Cl.** ..... **D16/202; D16/200; D16/218**

(58) **Field of Classification Search** ..... D16/200–206, D16/219, 208–209, 217, 242, 244–245; D21/514; 248/373–376; 358/906, 909.1; 396/419, 396/428, 427, 535–541; 348/143, 14, 13, 348/17, 838; 455/556, 557; D14/347, 496  
See application file for complete search history.

(56) **References Cited**

**U.S. PATENT DOCUMENTS**

D182,079 S *	2/1958	Macomber .....	D16/219
D323,843 S *	2/1992	Arai .....	D16/208
D345,987 S *	4/1994	Nihei .....	D16/209
D423,544 S *	4/2000	Yamamoto et al. ....	D16/218
6,220,770 B1 *	4/2001	Sakurai .....	396/538
D445,439 S *	7/2001	Yokokawa .....	D16/202
D508,711 S *	8/2005	Suzuki .....	D16/218
D512,450 S *	12/2005	Jinde .....	D16/202
2004/0017506 A1 *	1/2004	Livingston .....	348/374

2004/0169772 A1\* 9/2004 Matsui et al. .... 348/375  
\* cited by examiner

*Primary Examiner*—Ian Simmons  
*Assistant Examiner*—Wan Laymon  
(74) *Attorney, Agent, or Firm*—Blakely, Sokoloff Taylor & Zafman LLP

(57) **CLAIM**

The ornamental design for a digital video recorder device, as shown and described.

**DESCRIPTION**

FIG. 1 is a front perspective view of a digital video recorder device showing our new design;

FIG. 2 is a back perspective view thereof;

FIG. 3 is a back view thereof;

FIG. 4 is a front view thereof;

FIG. 5 is a right side view thereof;

FIG. 6 is a left side view thereof;

FIG. 7 is a top side view thereof;

FIG. 8 is a bottom side view thereof;

FIG. 9 is a front perspective view of a second embodiment of a digital video recorder device;

FIG. 10 is a back perspective view of FIG. 9;

FIG. 11 is a back view of FIG. 9;

FIG. 12 is a front view of FIG. 9;

FIG. 13 is a right side view of FIG. 9;

FIG. 14 is a left side view of FIG. 9;

FIG. 15 is a top side view of FIG. 9; and,

FIG. 16 is a bottom side view of FIG. 9.

**1 Claim, 8 Drawing Sheets**

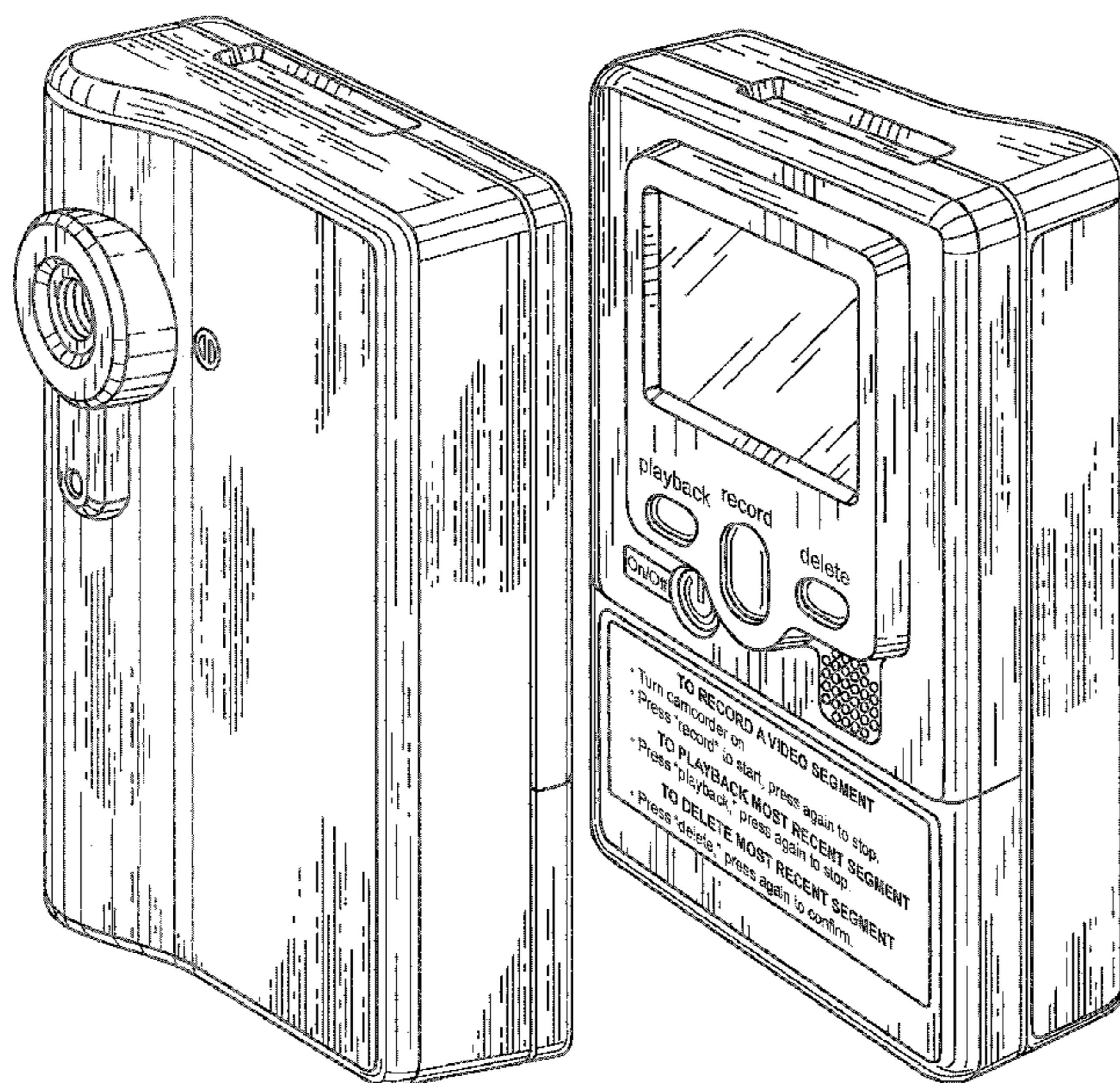

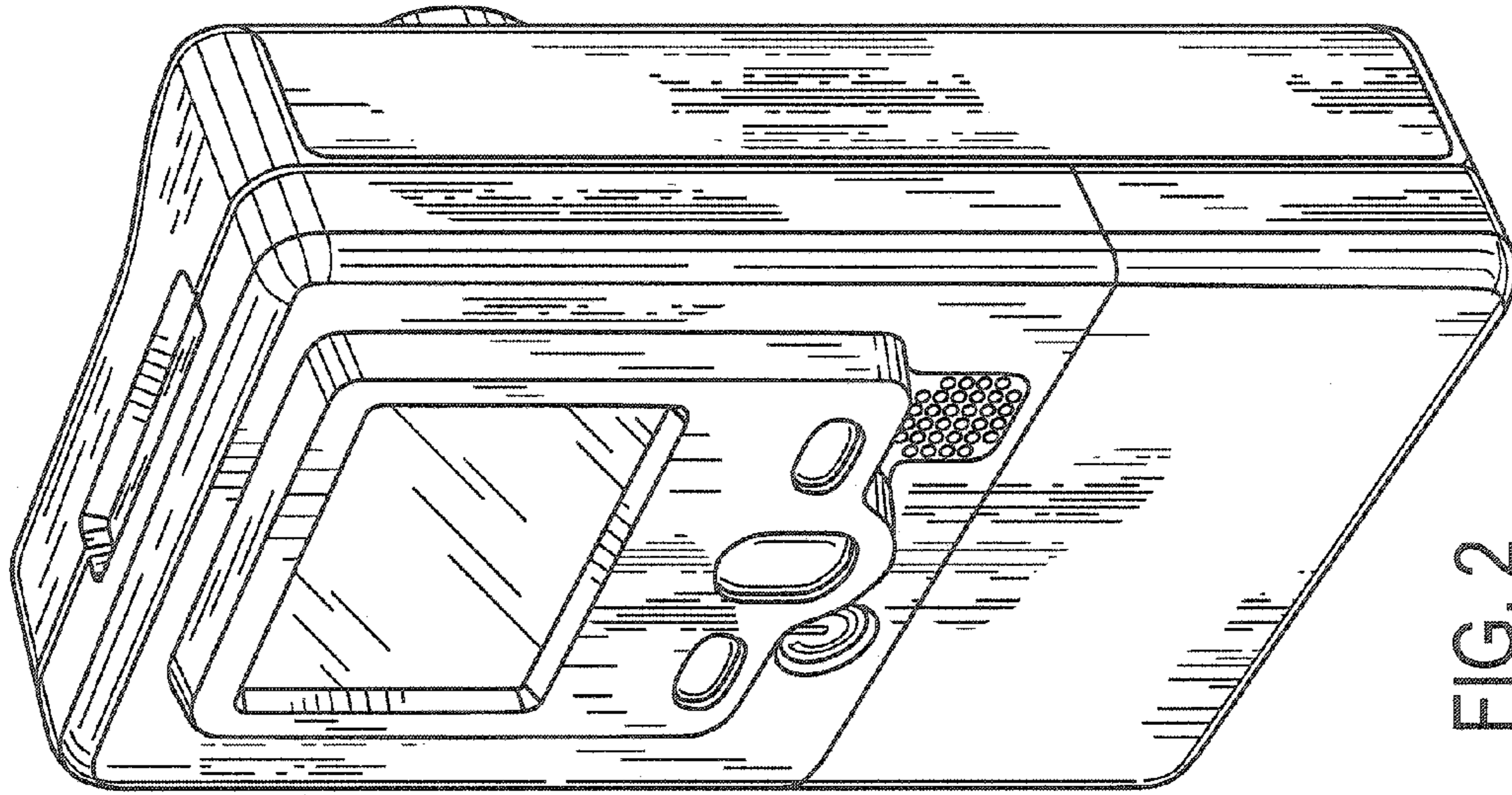

FIG. 2

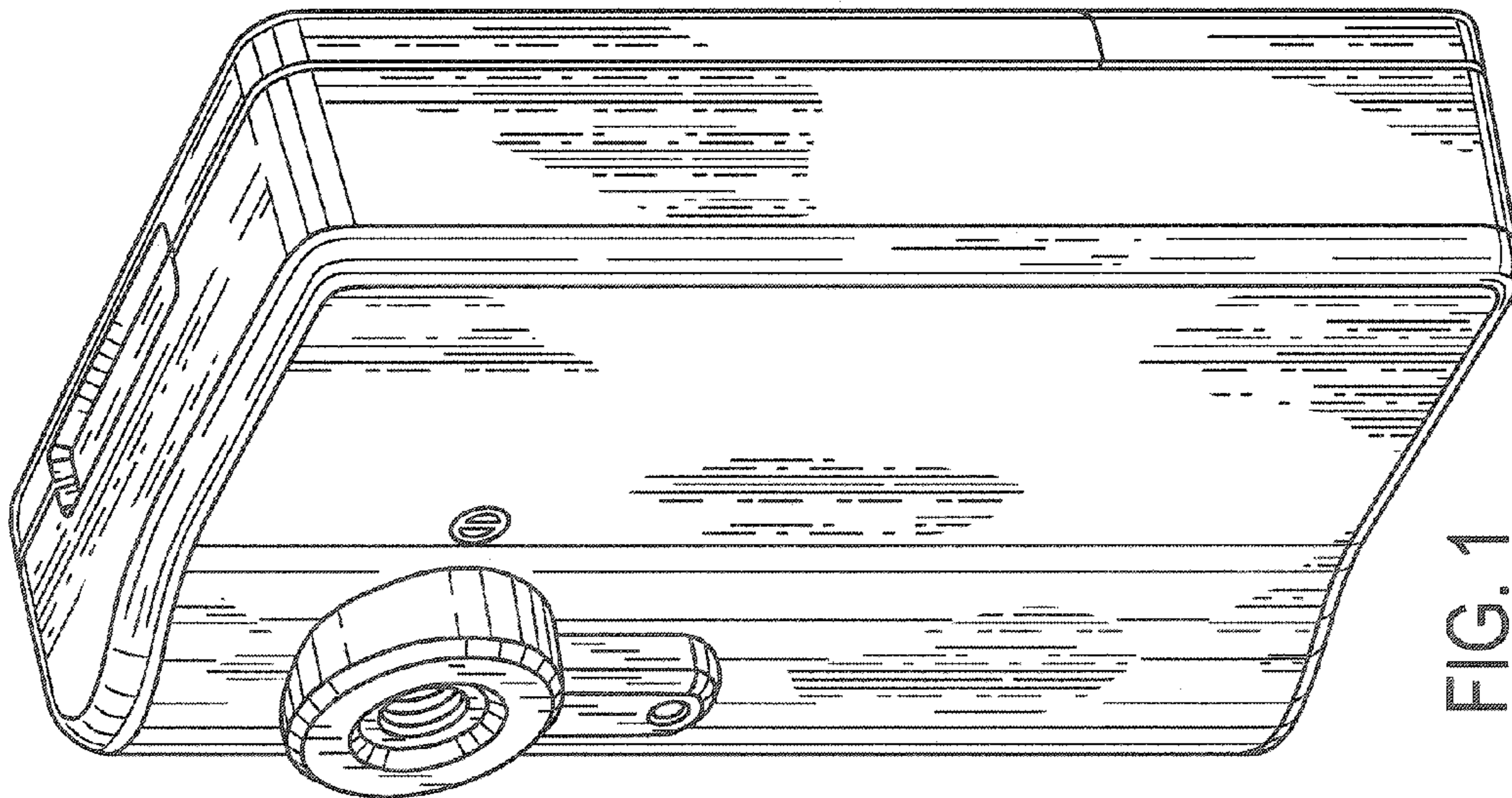

FIG. 1

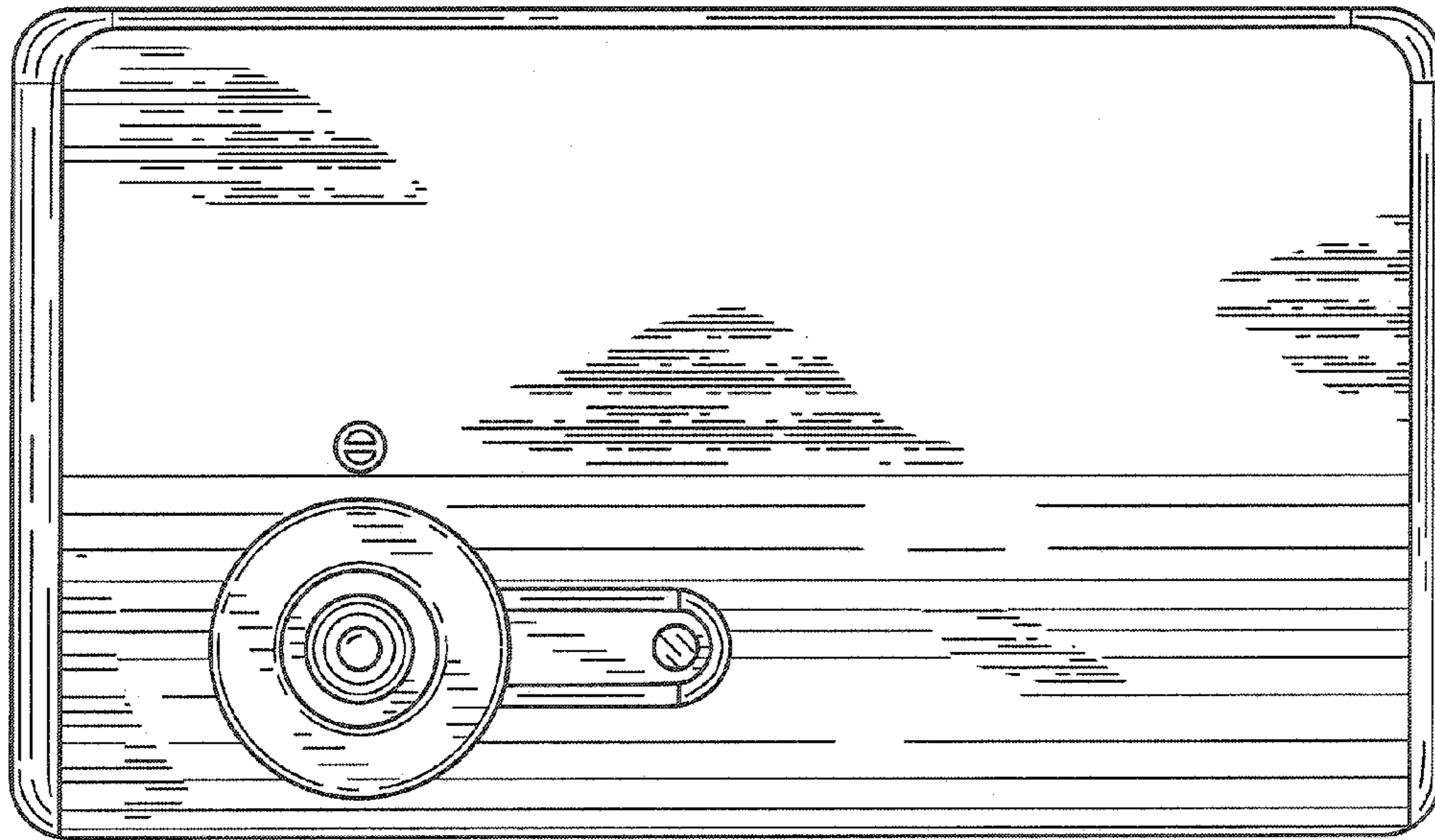

FIG. 4

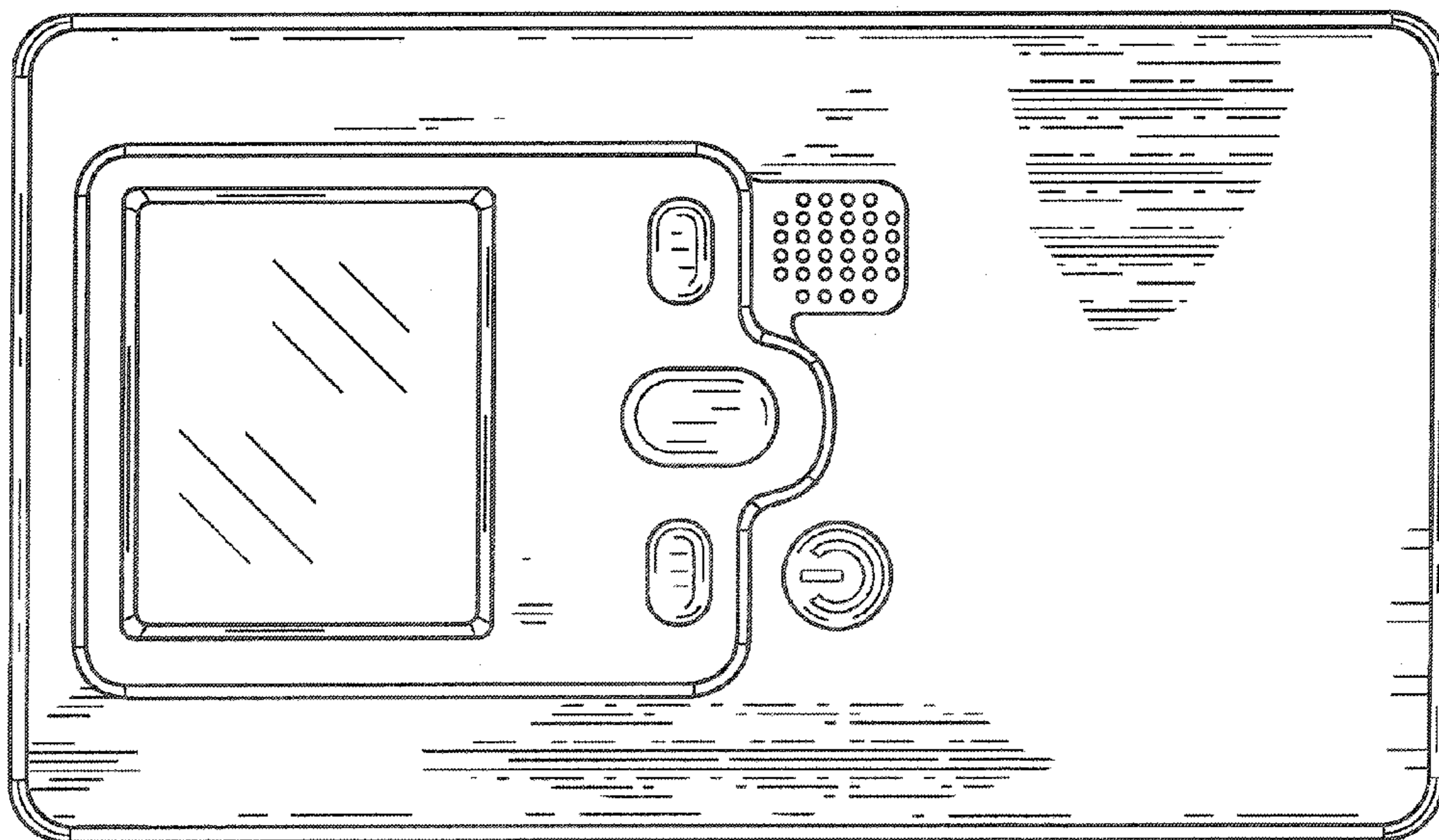

FIG. 3

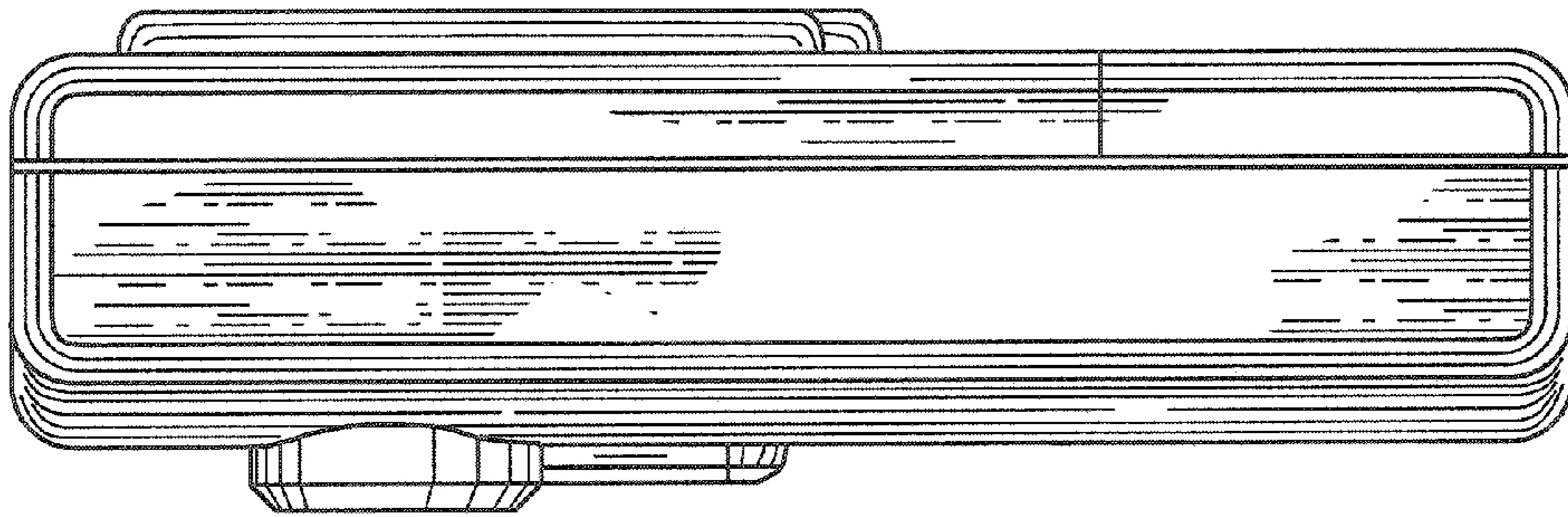

FIG. 6

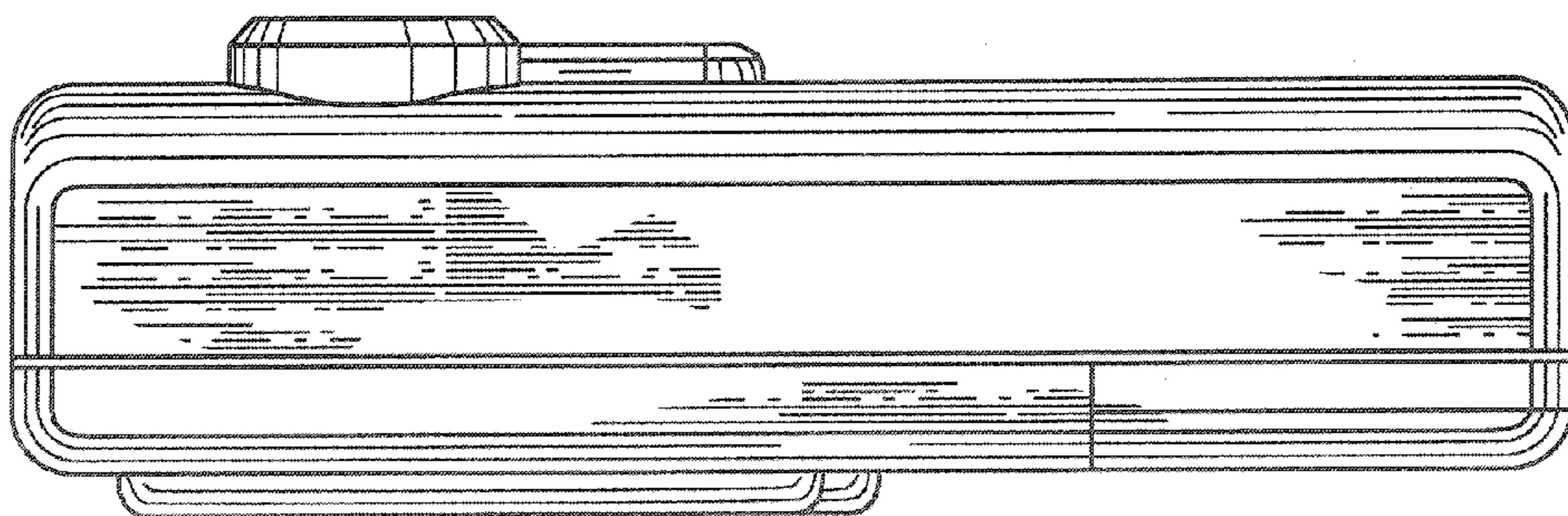

FIG. 5

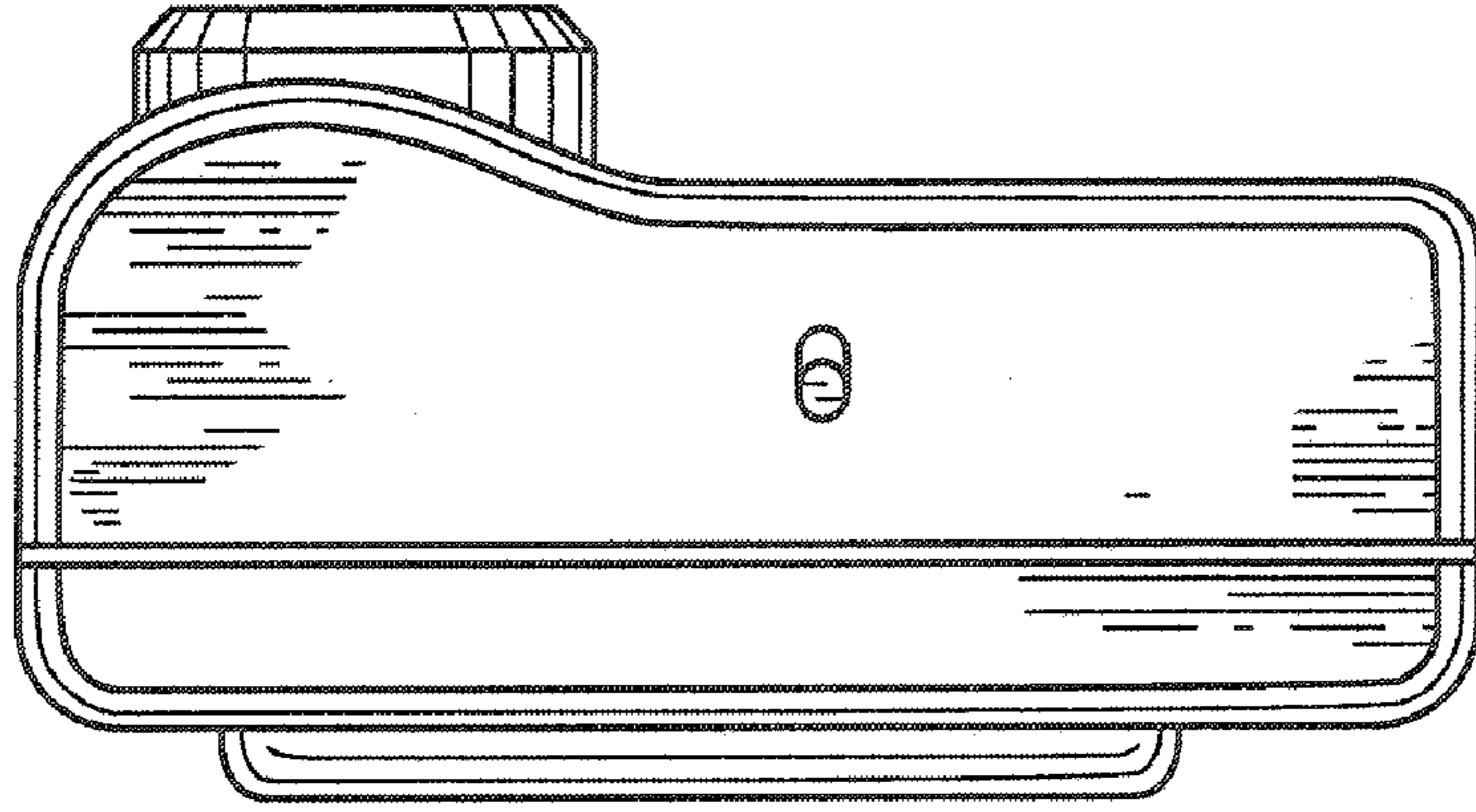

FIG. 8

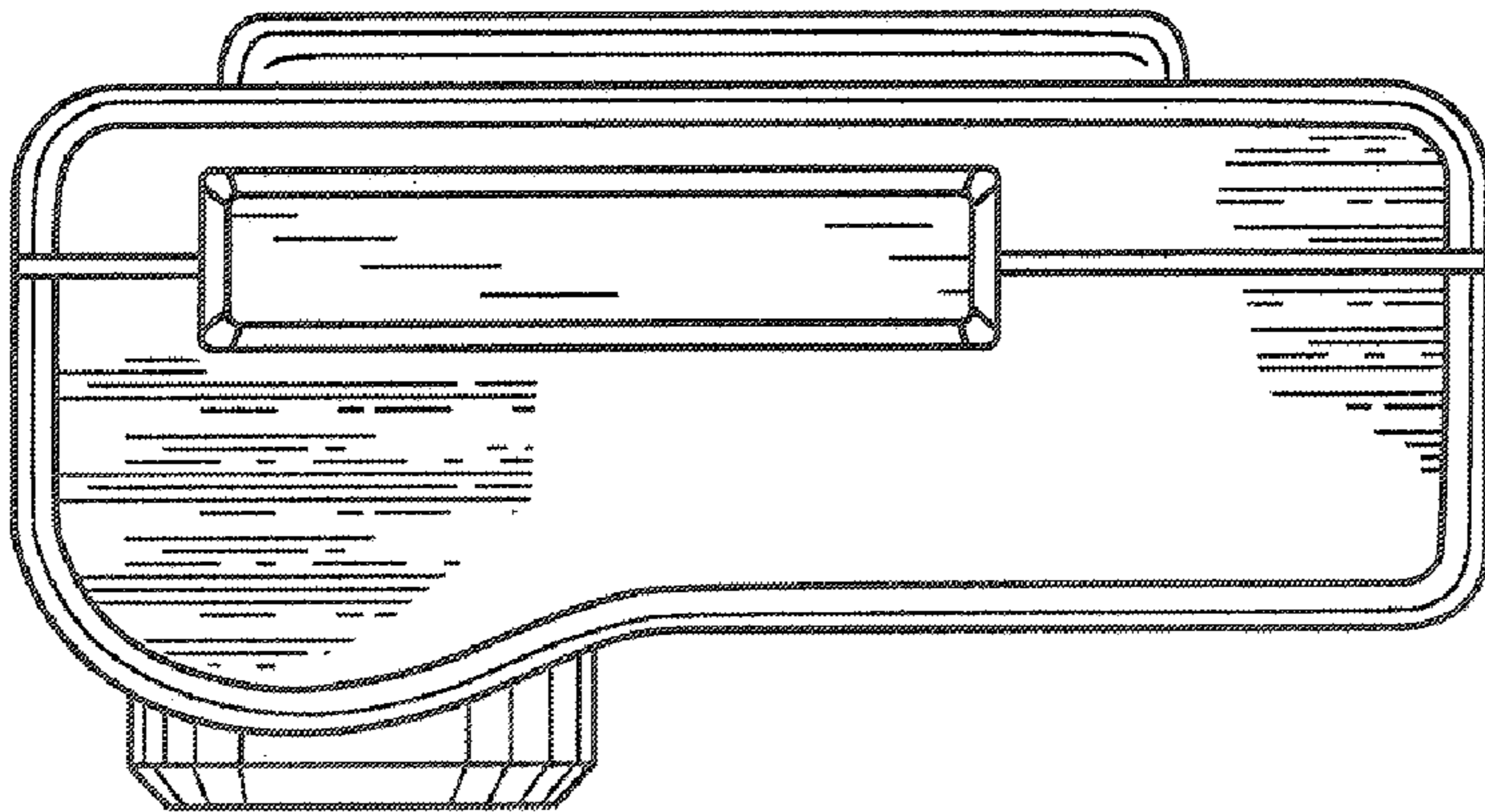

FIG. 7

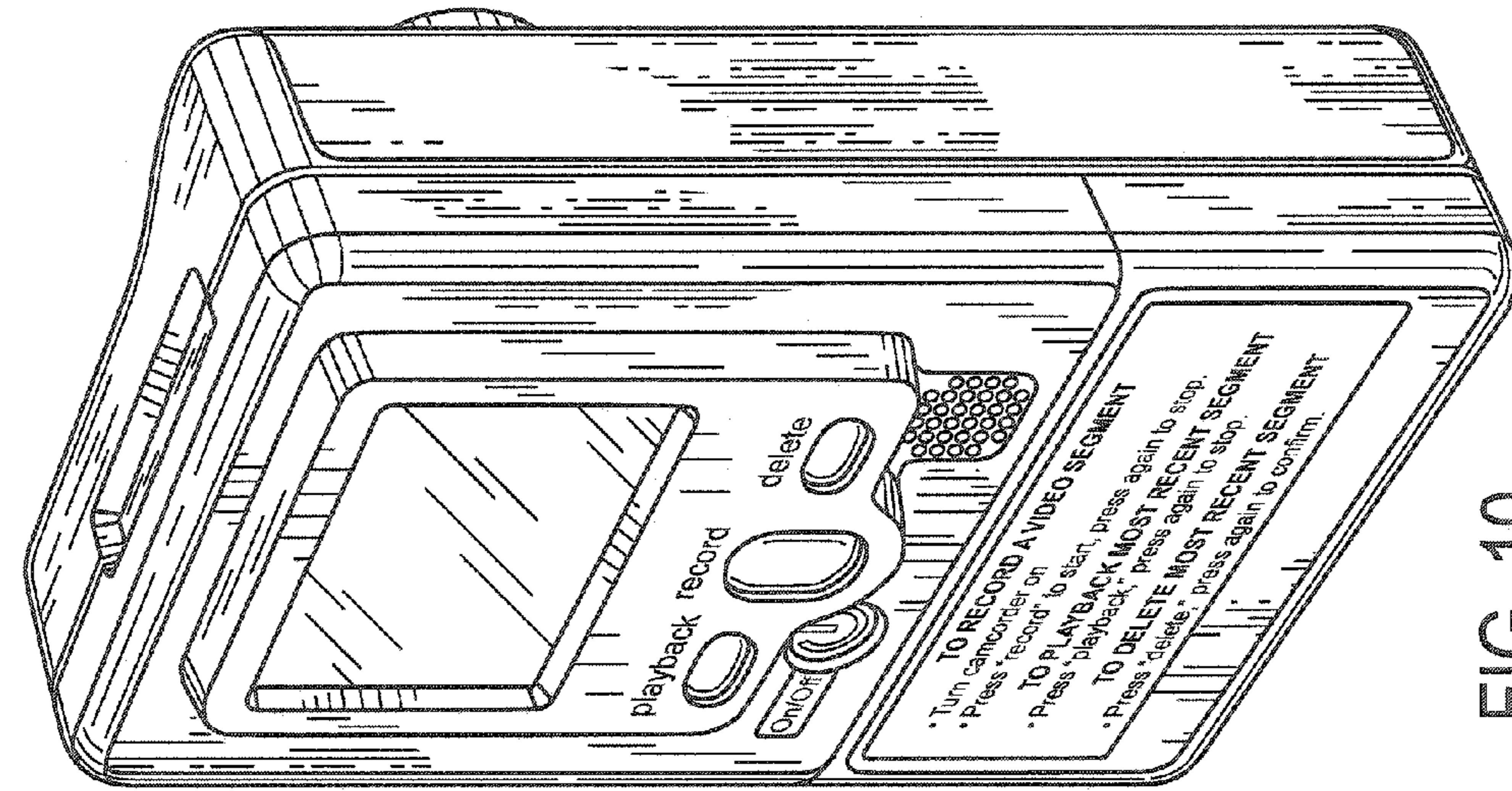

FIG. 9

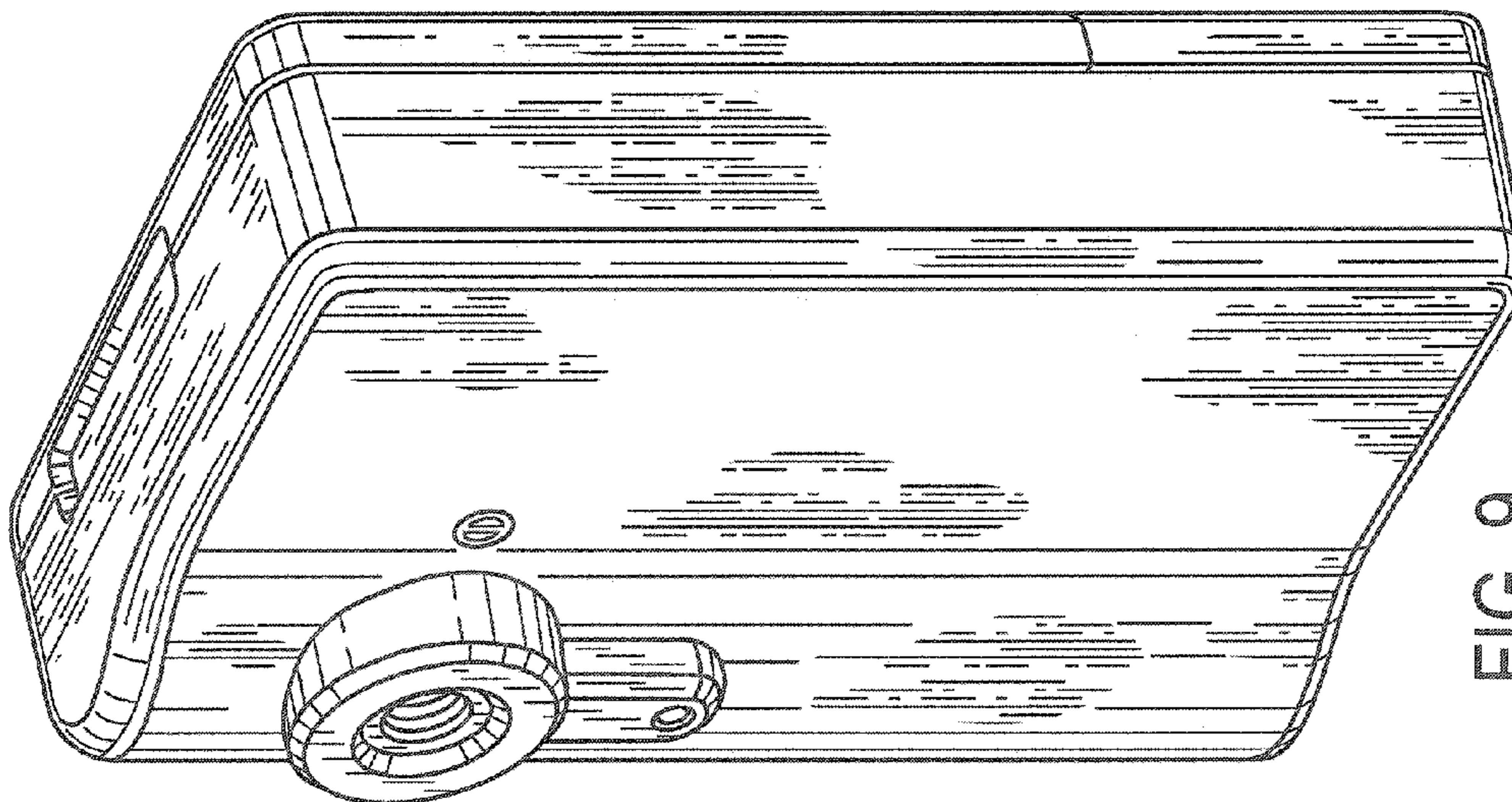

FIG. 10

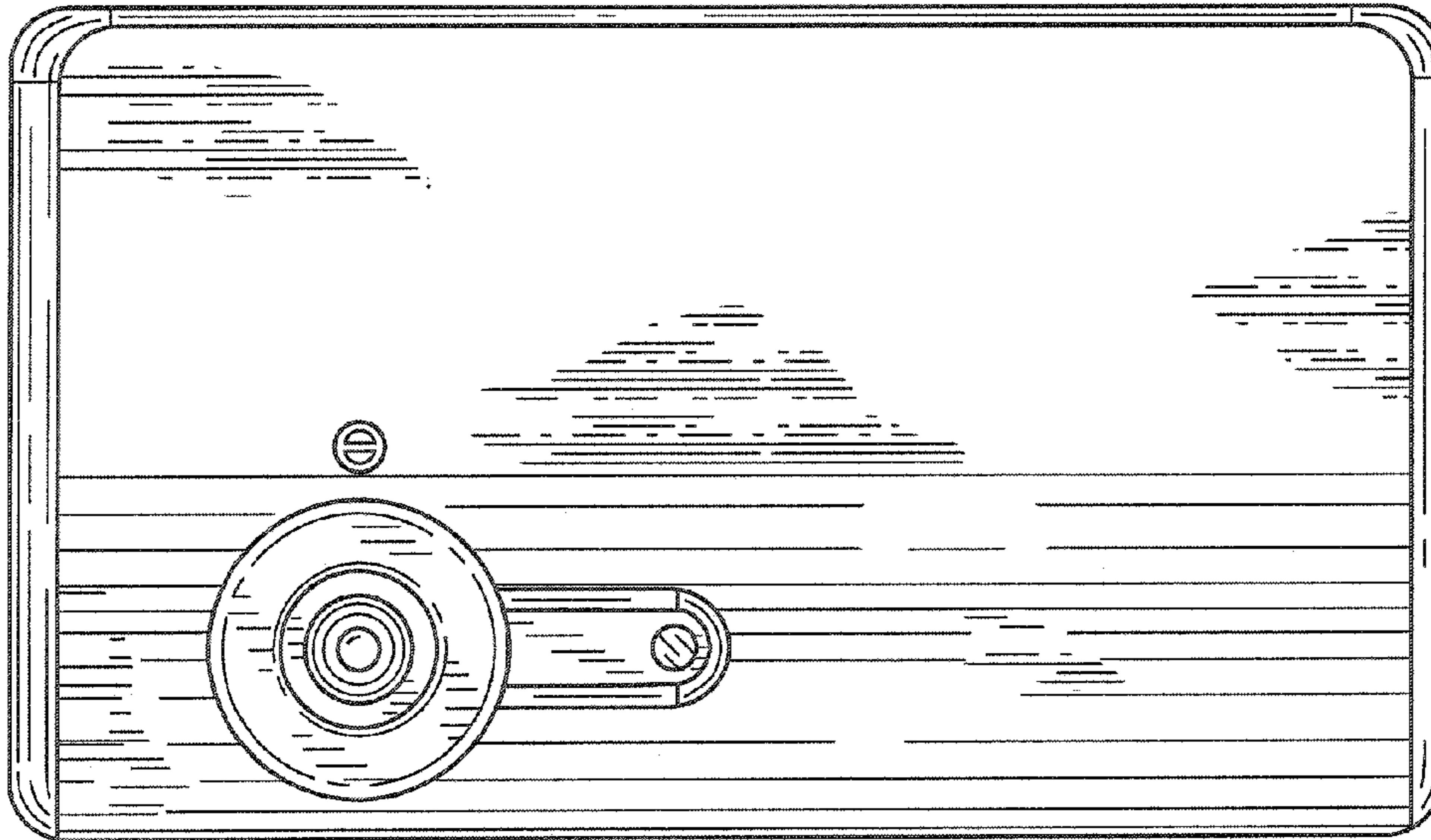

FIG. 12

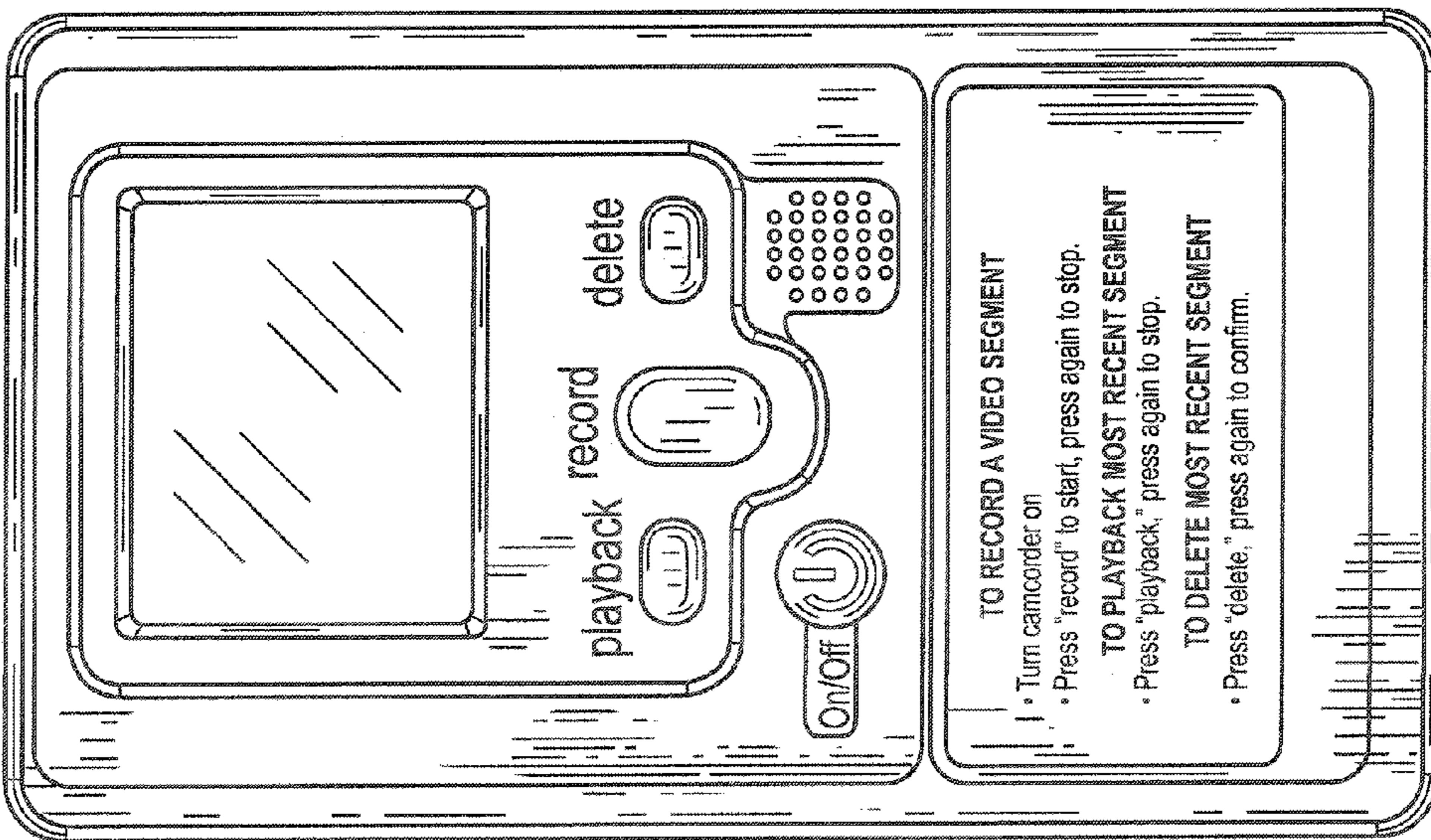

FIG. 11

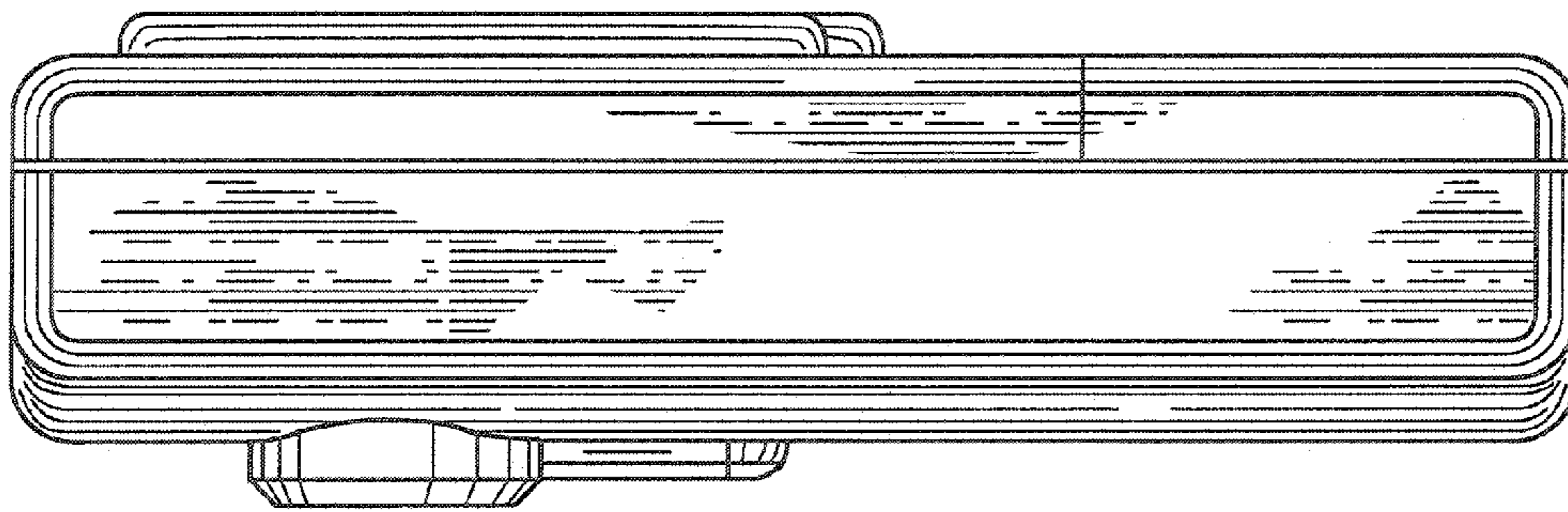

FIG. 14

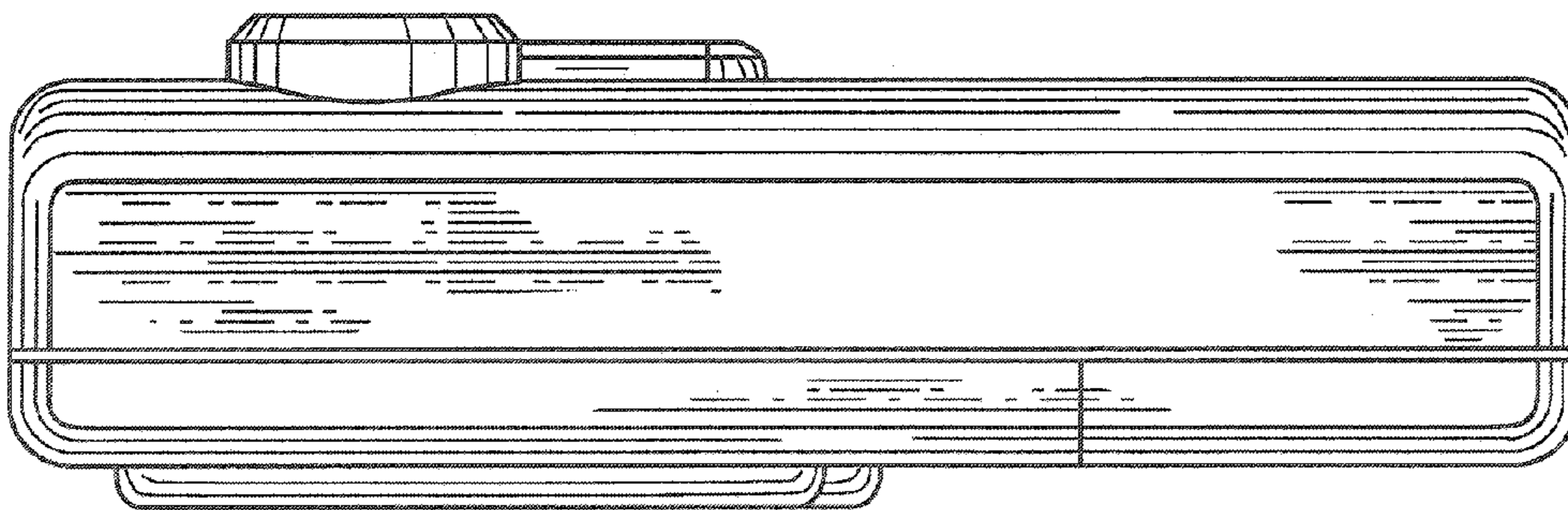

FIG. 13



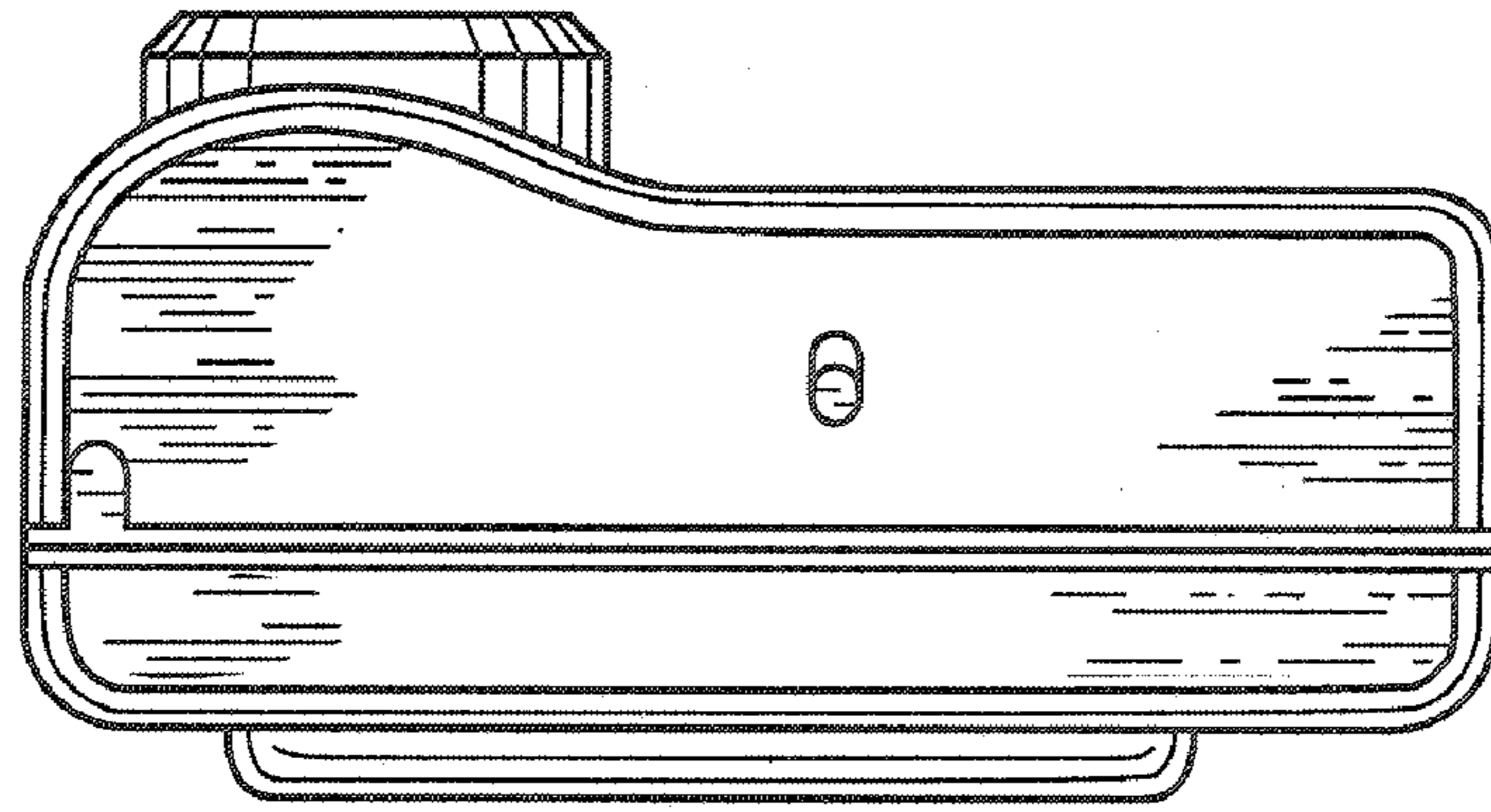

FIG. 16

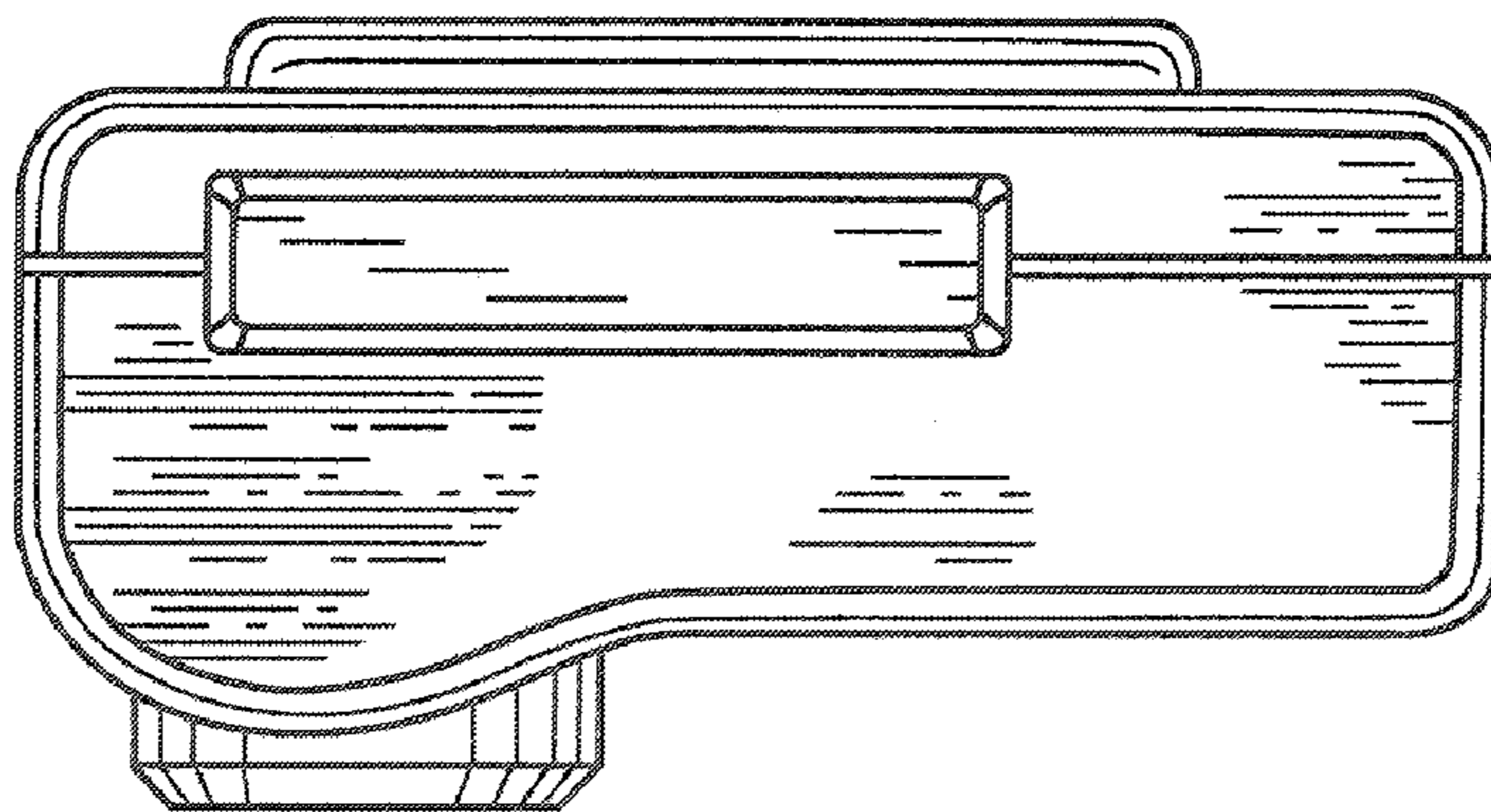

FIG. 15