



US00D552140S

(12) **United States Design Patent**  
**Tonegawa**

(10) **Patent No.:** **US D552,140 S**

(45) **Date of Patent:** **\*\* Oct. 2, 2007**

(54) **BINOCULARS**

(75) Inventor: **Kenji Tonegawa**, Kawasaki (JP)

(73) Assignee: **Nikon Corporation**, Tokyo (JP)

(\*\*) Term: **14 Years**

(21) Appl. No.: **29/262,502**

(22) Filed: **Jul. 5, 2006**

(30) **Foreign Application Priority Data**

Jan. 30, 2006 (JP) ..... 2006-001845

(51) **LOC (8) Cl.** ..... **16-06**

(52) **U.S. Cl.** ..... **D16/133**

(58) **Field of Classification Search** ..... D16/130,  
D16/133, 136; 39/408-412, 414-420, 804,  
39/809

See application file for complete search history.

(56) **References Cited**

**U.S. PATENT DOCUMENTS**

D238,304 S *	12/1975	Hengst et al.	.....	D16/133
4,306,764 A *	12/1981	Kikuchi	.....	359/414
4,329,013 A *	5/1982	Hengst	.....	359/418
D299,724 S *	2/1989	Aoki	.....	D16/133
D392,986 S *	3/1998	Katou	.....	D16/133
D395,055 S *	6/1998	Lee	.....	D16/133
D412,177 S *	7/1999	Fujii	.....	D16/133
6,476,963 B1 *	11/2002	Chen	.....	359/412

D473,248 S *	4/2003	Ono	.....	D16/133
D492,335 S *	6/2004	Watanabe	.....	D16/133
D513,026 S *	12/2005	Yanai et al.	.....	D16/133
D519,538 S *	4/2006	Hayamizu	.....	D16/133

**FOREIGN PATENT DOCUMENTS**

JP S 1209746 6/2004

\* cited by examiner

*Primary Examiner*—Paula A. Greene

(74) *Attorney, Agent, or Firm*—Oliff & Berridge, PLC

(57) **CLAIM**

The ornamental design for a binoculars, as shown and described.

**DESCRIPTION**

FIG. 1 is a front perspective view of a binoculars showing my new design;

FIG. 2 is a front elevational view thereof;

FIG. 3 is a rear elevational view thereof;

FIG. 4 is a top plan view thereof;

FIG. 5 is a bottom plan view thereof;

FIG. 6 is a left side view thereof;

FIG. 7 is a right side view thereof; and,

FIG. 8 is a front perspective view thereof, in a folded position.

**1 Claim, 8 Drawing Sheets**

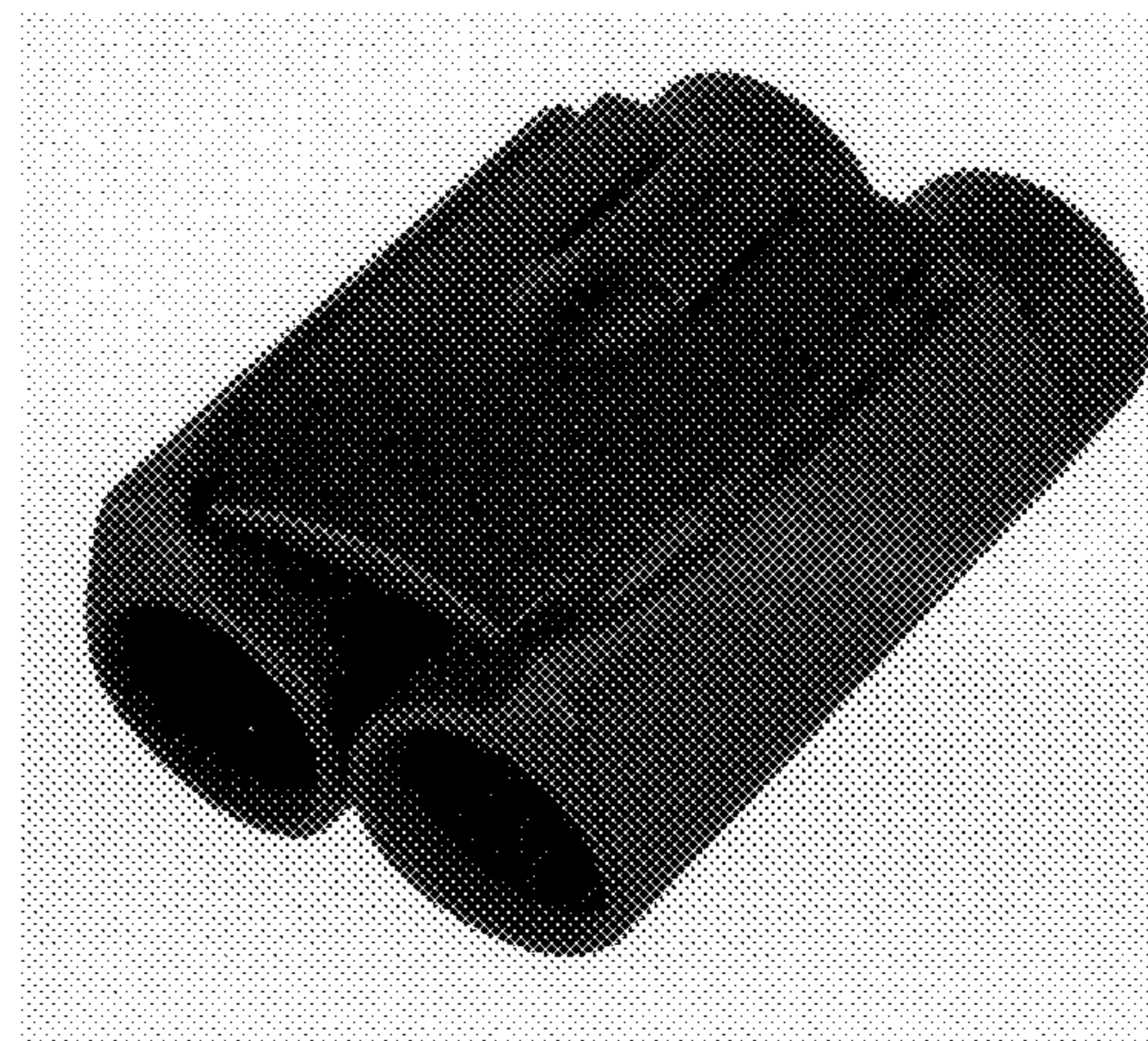
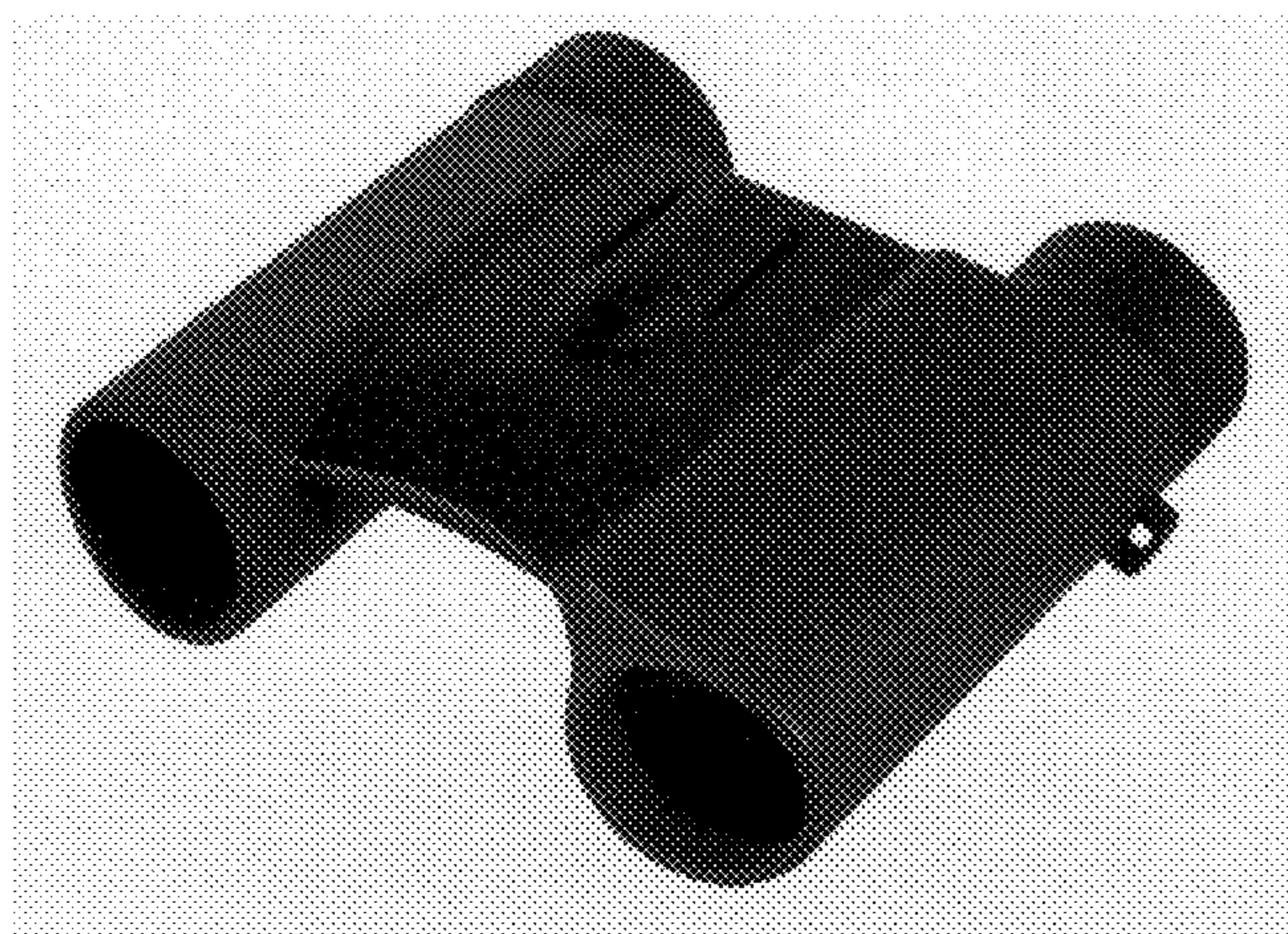

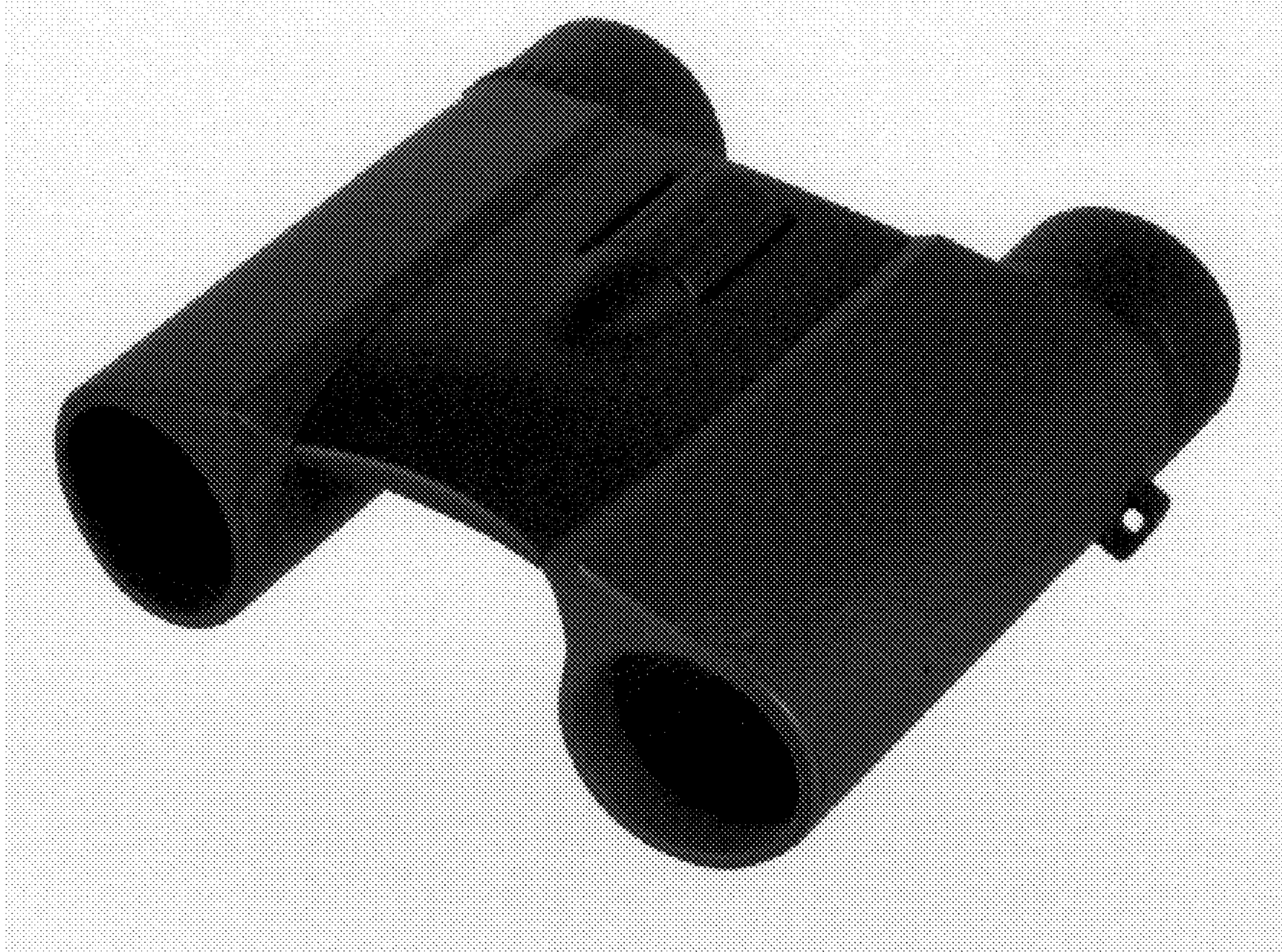

FIG. 1

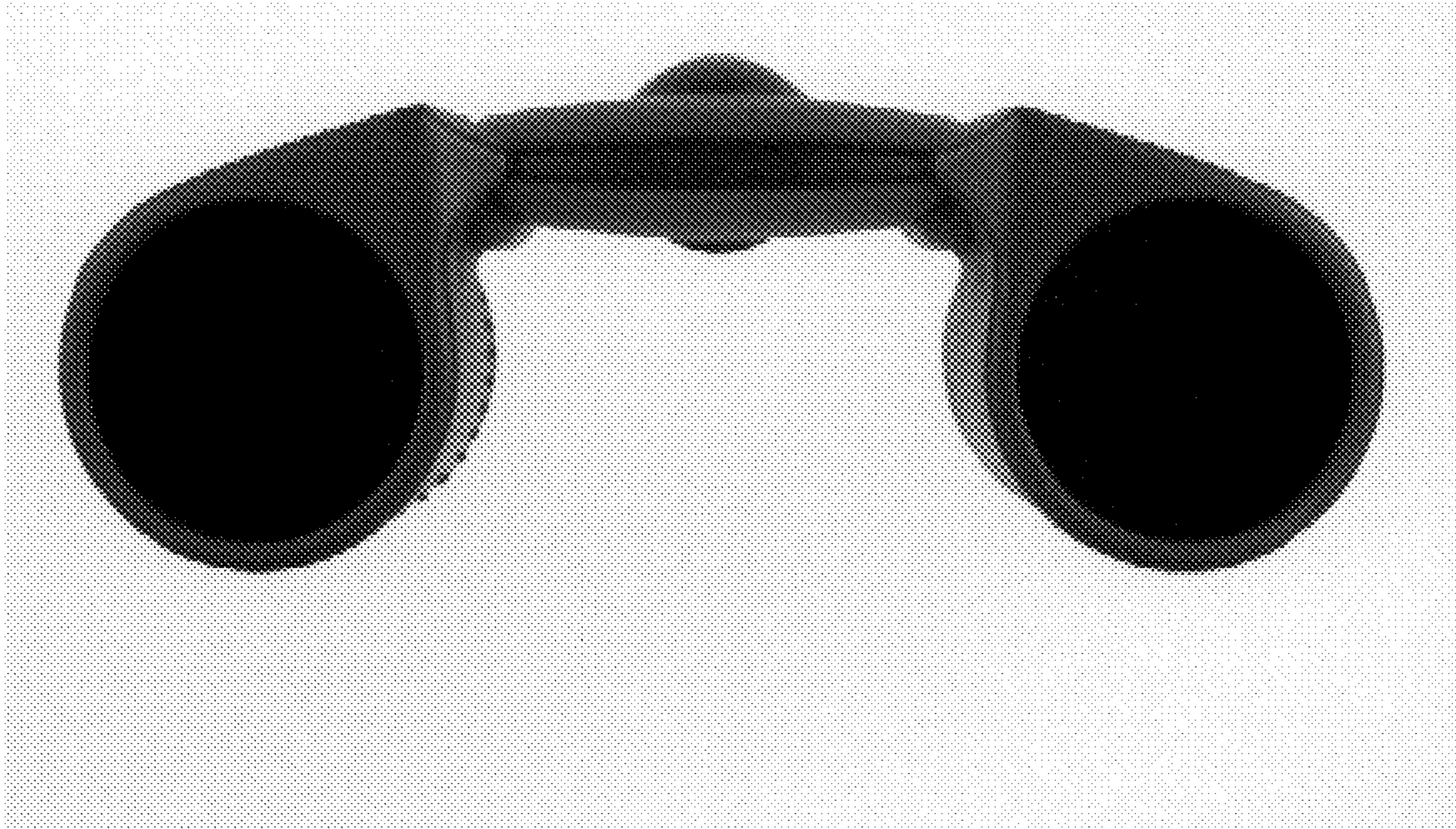

FIG. 2

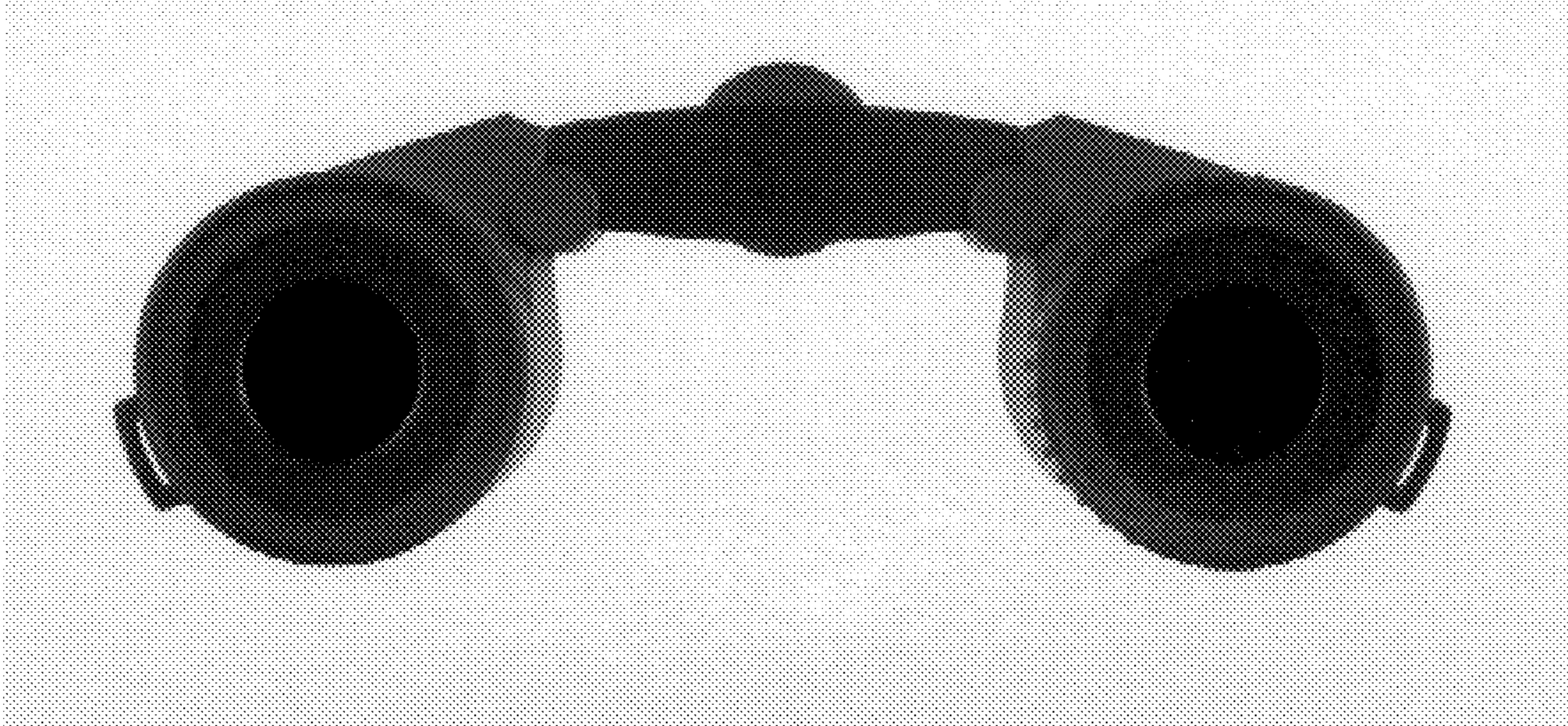

FIG.3



FIG.4



FIG. 5

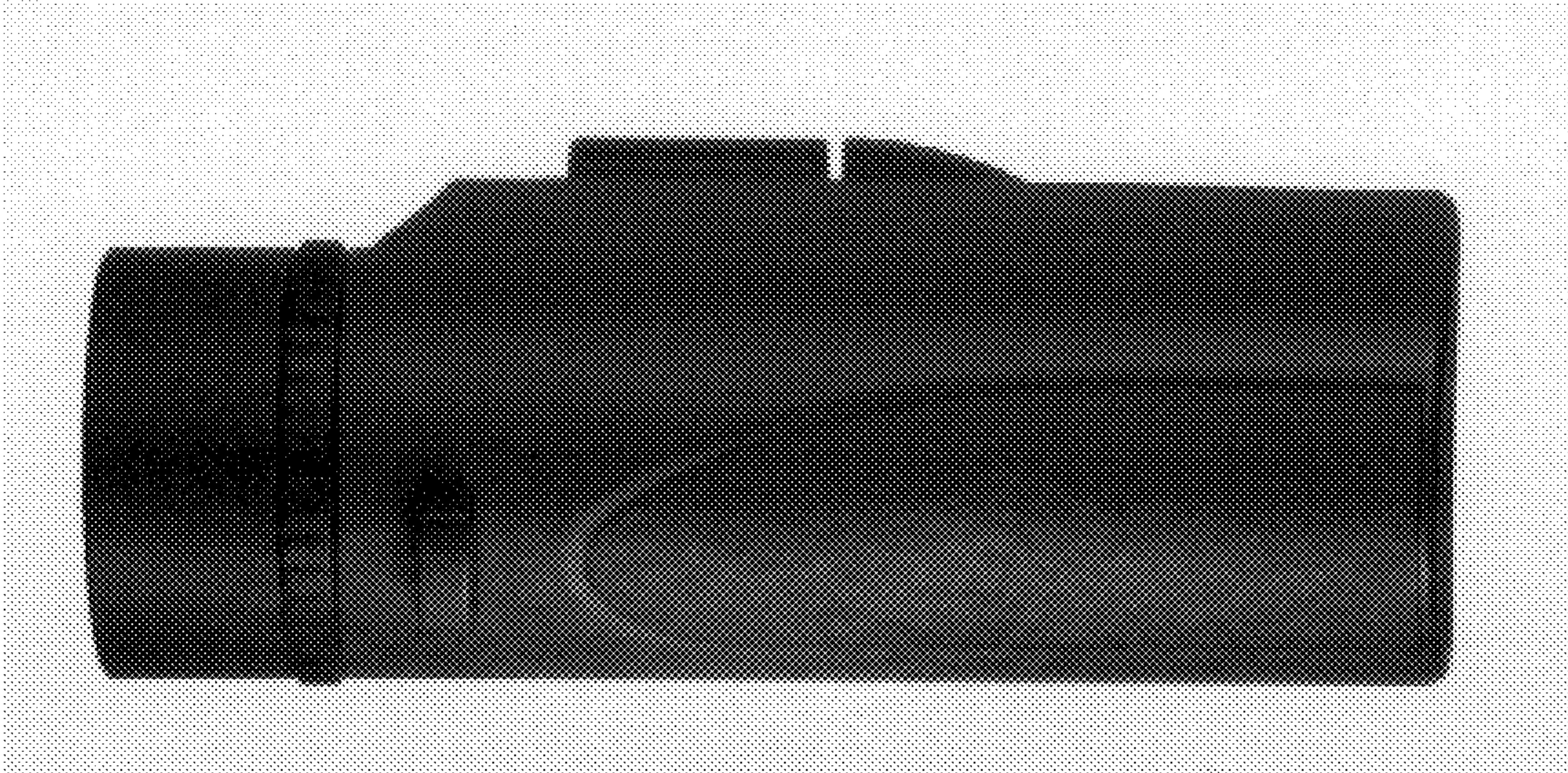

FIG.6

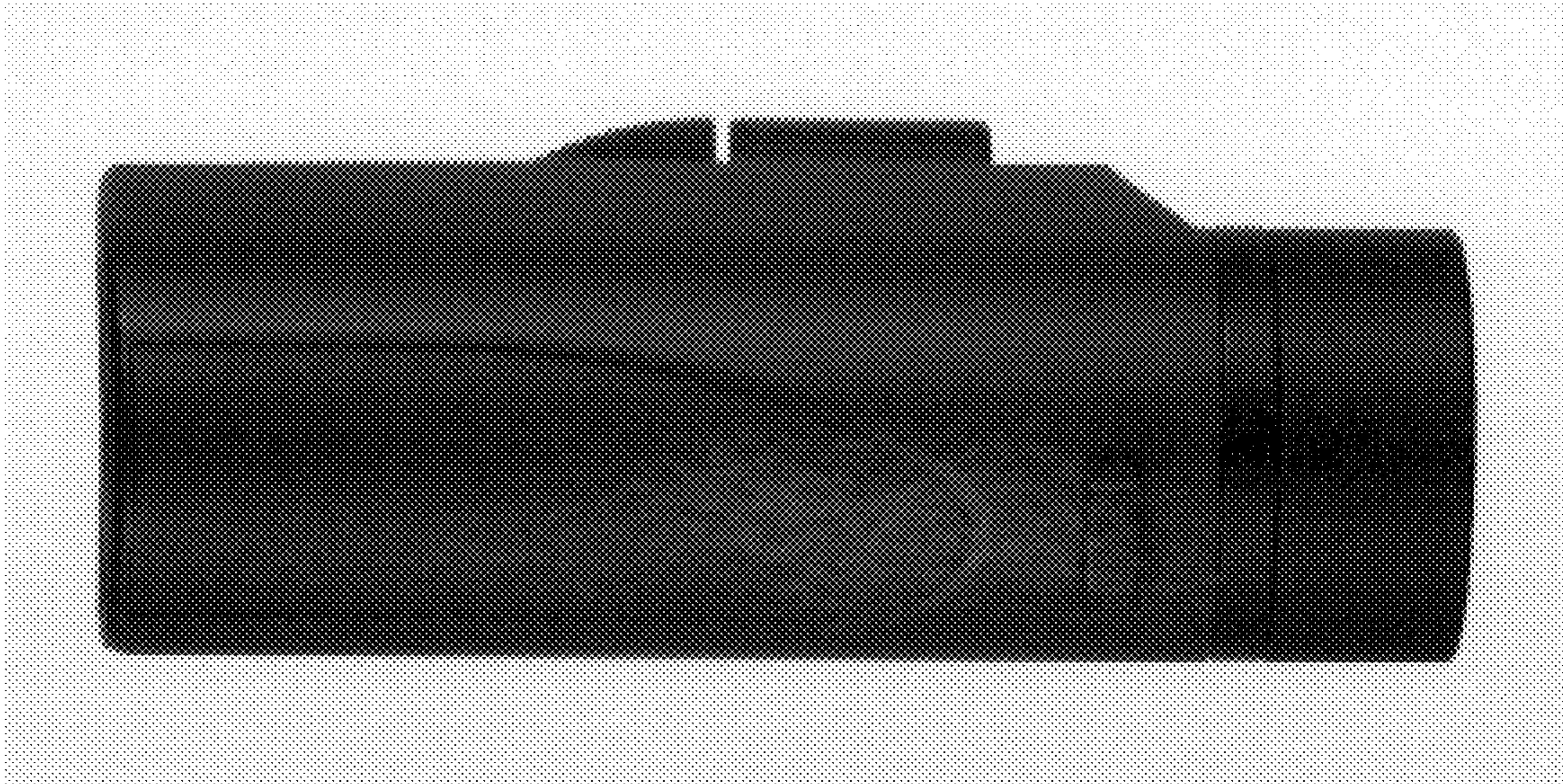

FIG.7





FIG.8