



US00D552069S

(12) **United States Design Patent**
Lee et al.

(10) **Patent No.:** **US D552,069 S**
(45) **Date of Patent:** **** Oct. 2, 2007**

(54) **PORTABLE PHONE**

(75) Inventors: **Ji-Young Lee**, Seongnam-si (KR);
Sang-Min Hyun, Seoul (KR);
Chang-Soo Lee, Incheon (KR)

(73) Assignee: **Samsung Electronics Co., Ltd.**,
Suwon-Si (KR)

(**) Term: **14 Years**

(21) Appl. No.: **29/255,181**

(22) Filed: **Mar. 7, 2006**

(30) **Foreign Application Priority Data**

Sep. 29, 2005 (KR) 30-2005-0032990

(51) **LOC (8) Cl.** **14-03**

(52) **U.S. Cl.** **D14/138**

(58) **Field of Classification Search** D14/137,
D14/138, 147, 218, 341-347, 496; 455/90.3,
455/556.1, 556.2, 575.1, 575.3, 575.4; 379/433.01-433.13;
361/814; 348/14.02

See application file for complete search history.

(56) **References Cited**

U.S. PATENT DOCUMENTS

D466,096 S *	11/2002	Takada	D14/138
D479,215 S *	9/2003	Yokoyama	D14/138
D495,695 S *	9/2004	Yugaya	D14/346
D508,240 S *	8/2005	Lee et al.	D14/138
D508,473 S *	8/2005	Lee et al.	D14/138
D519,998 S *	5/2006	Park	D14/346
D525,608 S *	7/2006	Ryu	D14/138
D525,609 S *	7/2006	Kim et al.	D14/138
D526,302 S *	8/2006	Kim	D14/138
D526,303 S *	8/2006	Kim et al.	D14/138
D527,364 S *	8/2006	Lee et al.	D14/138
D527,366 S *	8/2006	Lee	D14/138
D528,096 S *	9/2006	Park	D14/138
D528,532 S *	9/2006	Dimitriadis et al.	D14/138
D529,472 S *	10/2006	Kim et al.	D14/138
D529,888 S *	10/2006	Lee et al.	D14/138
D529,891 S *	10/2006	Hyun et al.	D14/138

D531,608 S *	11/2006	Kim et al.	D14/138
D531,609 S *	11/2006	Kim et al.	D14/138
D531,977 S *	11/2006	Kim et al.	D14/138

(Continued)

OTHER PUBLICATIONS

Samsung D720, announced 1st quarter 2005, [online], [retrieved on Feb. 8, 2007]. Retrieved from Internet ,<URL: <http://www.gsmarena.com>>.*

(Continued)

Primary Examiner—Jeffrey Asch

Assistant Examiner—Bridget L. Eland

(74) *Attorney, Agent, or Firm*—Staas & Halsey LLP

(57) **CLAIM**

The ornamental design for a portable phone, as shown and described.

DESCRIPTION

This application claims subject matter that is related to that shown in co-pending U.S. patent application Ser. No. 29/255,182, filed concurrently herewith, and claiming the benefit of Korean Patent Application Serial No. 30-2005-32991, filed Sep. 29, 2005, and that shown in co-pending U.S. patent application Ser. No. 29/255,221, filed concurrently herewith, and claiming the benefit of Korean Patent Application Serial No. 30-2005-32992, filed Sep. 29, 2005.

FIG. 1 is a perspective view of the portable phone showing our design;

FIG. 2 is a front view thereof;

FIG. 3 is a rear view thereof;

FIG. 4 is a left side view thereof;

FIG. 5 is a right side view thereof;

FIG. 6 is a top plan view thereof;

FIG. 7 is a bottom plan view thereof;

FIG. 8 is a front, open view thereof; and,

FIG. 9 is a rear, open view thereof.

1 Claim, 6 Drawing Sheets

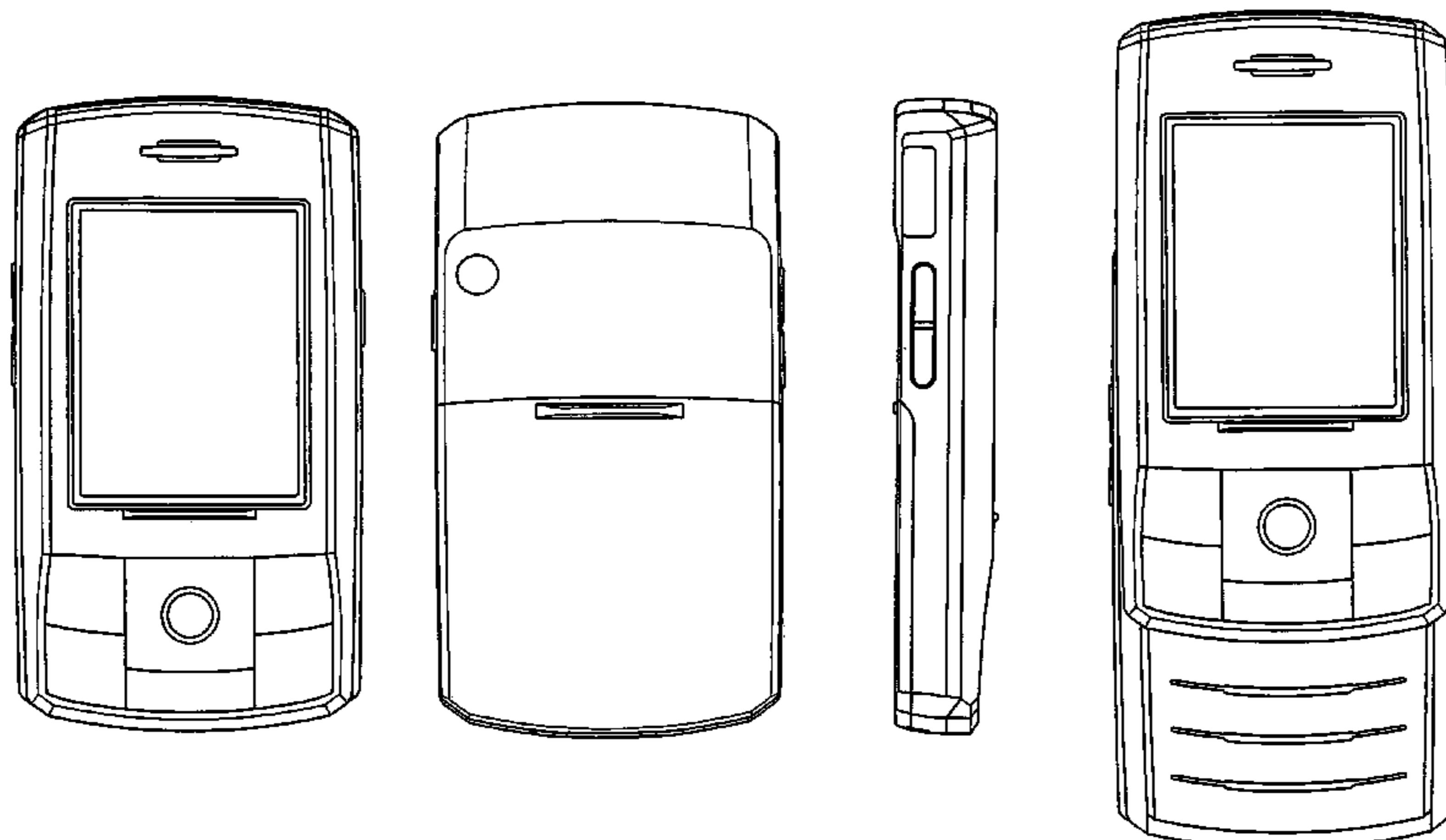

U.S. PATENT DOCUMENTS

D534,515 S * 1/2007 Kim et al. D14/138
D534,892 S * 1/2007 Lee et al. D14/138
D535,275 S * 1/2007 Kim et al. D14/138
2005/0233708 A1* 10/2005 Im et al. 455/90.3
2005/0255897 A1* 11/2005 Lee et al. 455/575.4
2006/0205450 A1* 9/2006 Amano et al. 455/575.4

OTHER PUBLICATIONS

Samsung D800, announced 4th quarter 2005, [online], [retrieved on Feb. 8, 2007]. Retrieved from Internet ,<URL: <http://www.gsmarena.com>>.*

BenQ U700, announced 1st quarter 2005, [online], [retrieved on Feb. 20, 2007]. Retrieved from Internet ,<URL: <http://www.gsmarena.com>>.*

Nokia 6280, announced Jun. 2005, [online], [retrieved on Feb. 16, 2007]. Retrieved from Internet ,<URL: <http://www.gsmarena.com>>.*

Samsung D410, announced 4th quarter 2003, [online], [retrieved on Feb. 8, 2007]. Retrieved from Internet ,<URL: <http://www.gsmarena.com>>.*

LG KS10, announced Feb. 2007, [online], [retrieved on Feb. 20, 2007]. Retrieved from Internet ,<URL: <http://www.gsmarena.com>>.*

Samsung D820, announced 4th quarter 2005, [online], [retrieved on Feb. 8, 2007]. Retrieved from Internet ,<URL: <http://www.gsmarena.com>>.*

Samsung E250, announced Oct. 2006, [online], [retrieved on Feb. 8, 2007]. Retrieved from Internet ,<URL: <http://www.gsmarena.com>>.*

U.S. Appl. No. 29/264,362, filed Aug. 9, 2006, Ji-Young Lee et al., Samsung Electronics Co., Ltd.

U.S. Appl. No. 29/255,221, filed Mar. 7, 2006, Ji-Young Lee et al., Samsung Electronics Co., Ltd.

* cited by examiner

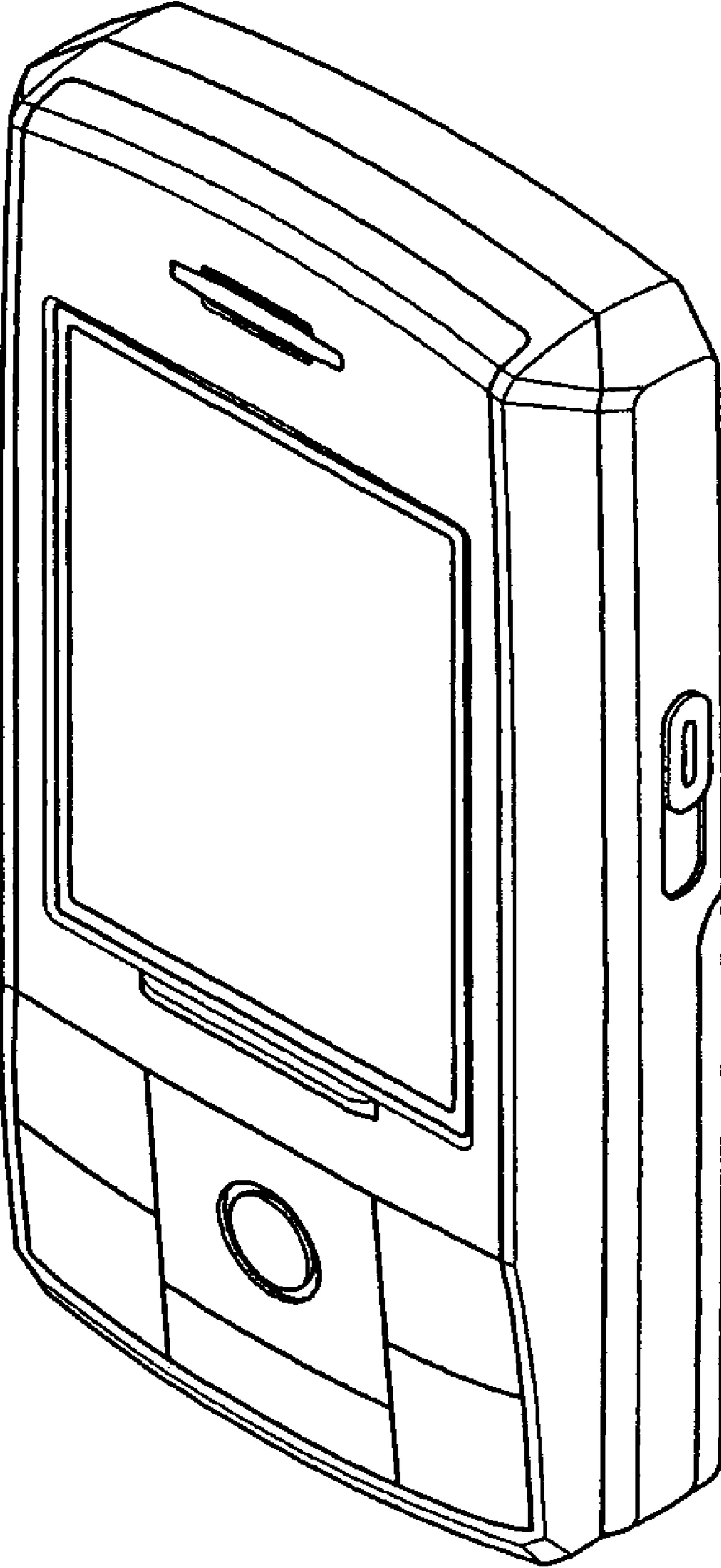

FIGURE 1

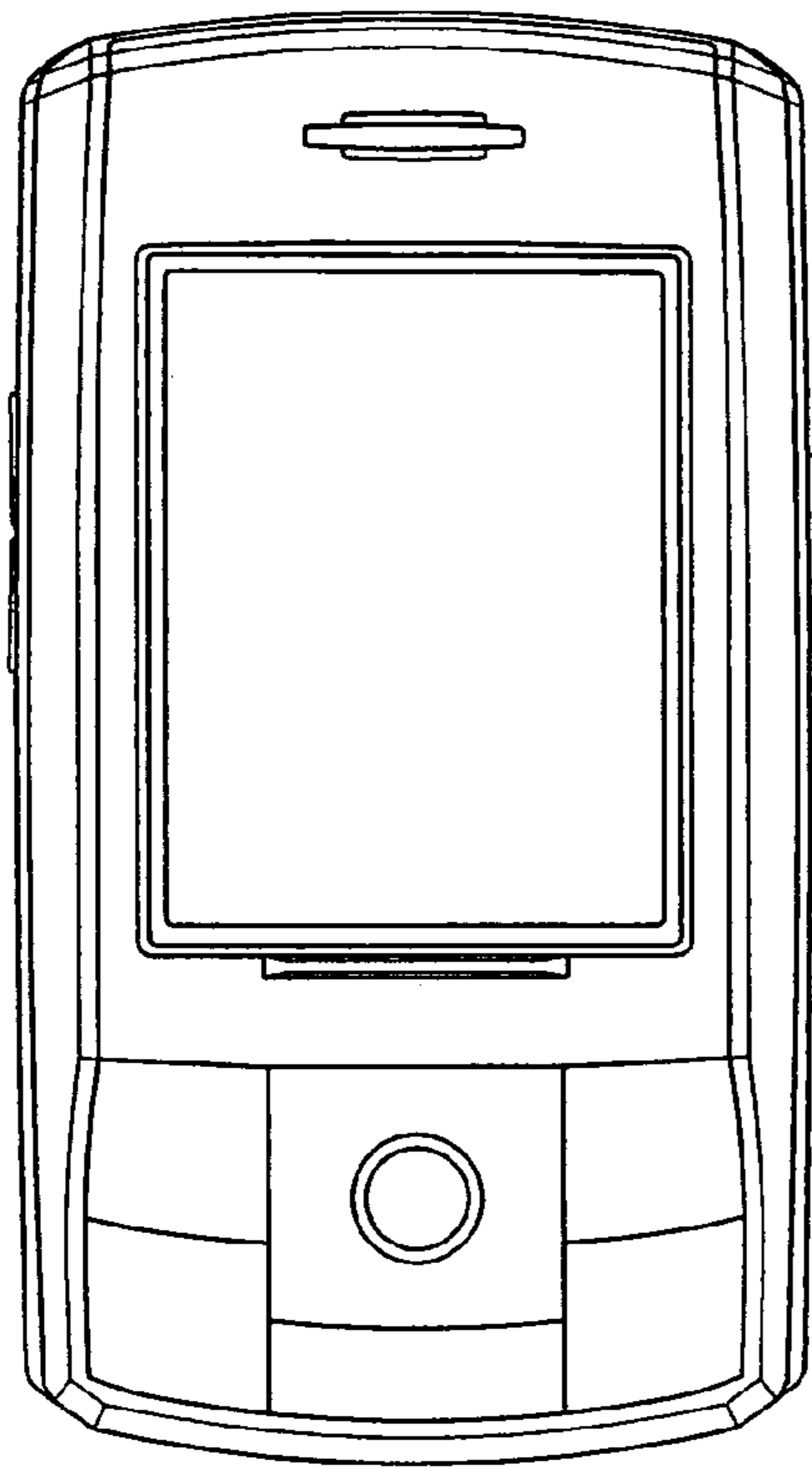

FIGURE 2

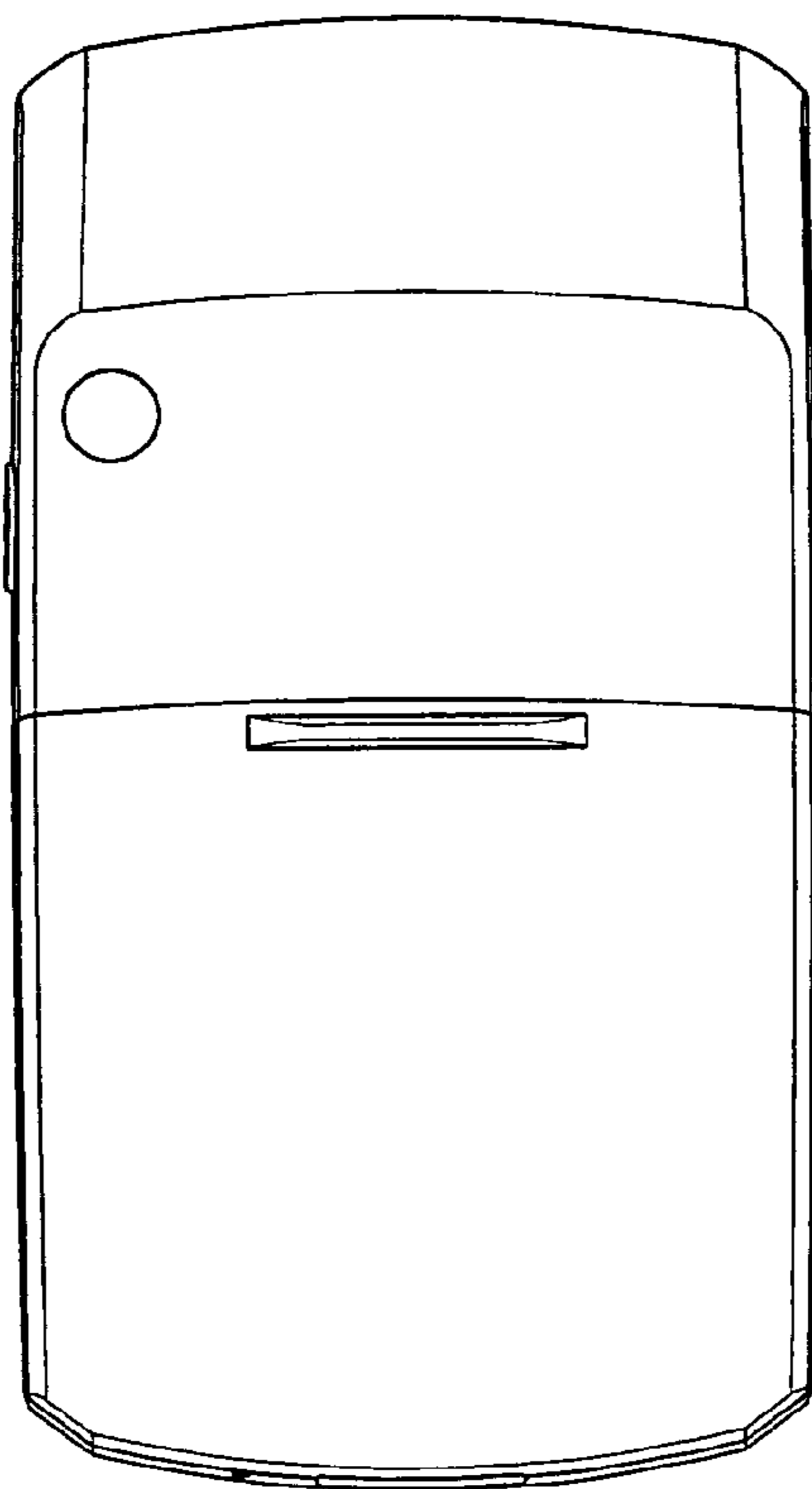

FIGURE 3

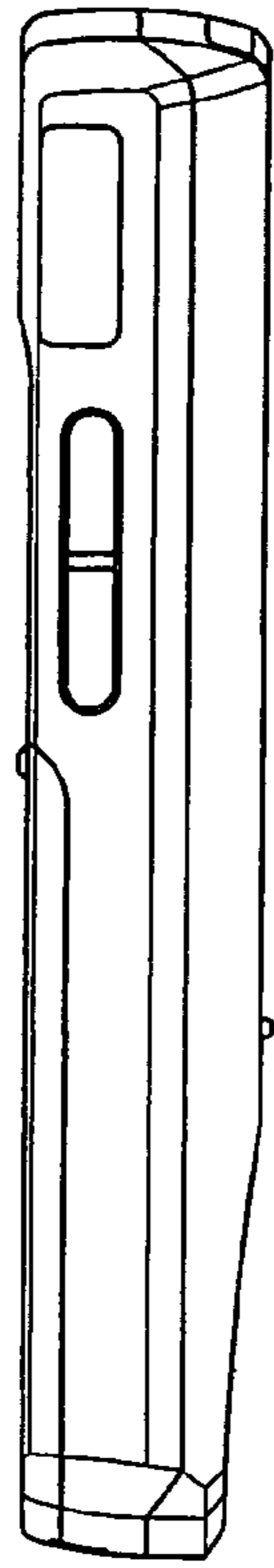

FIGURE 4

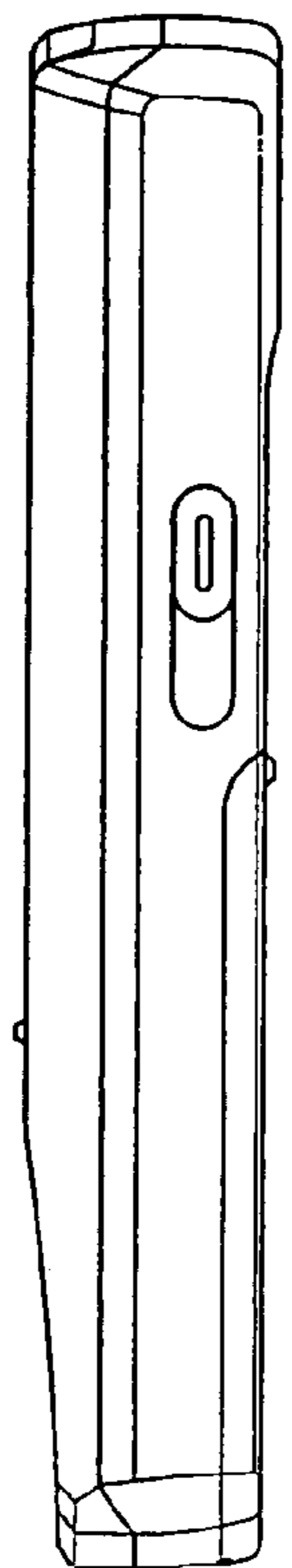

FIGURE 5

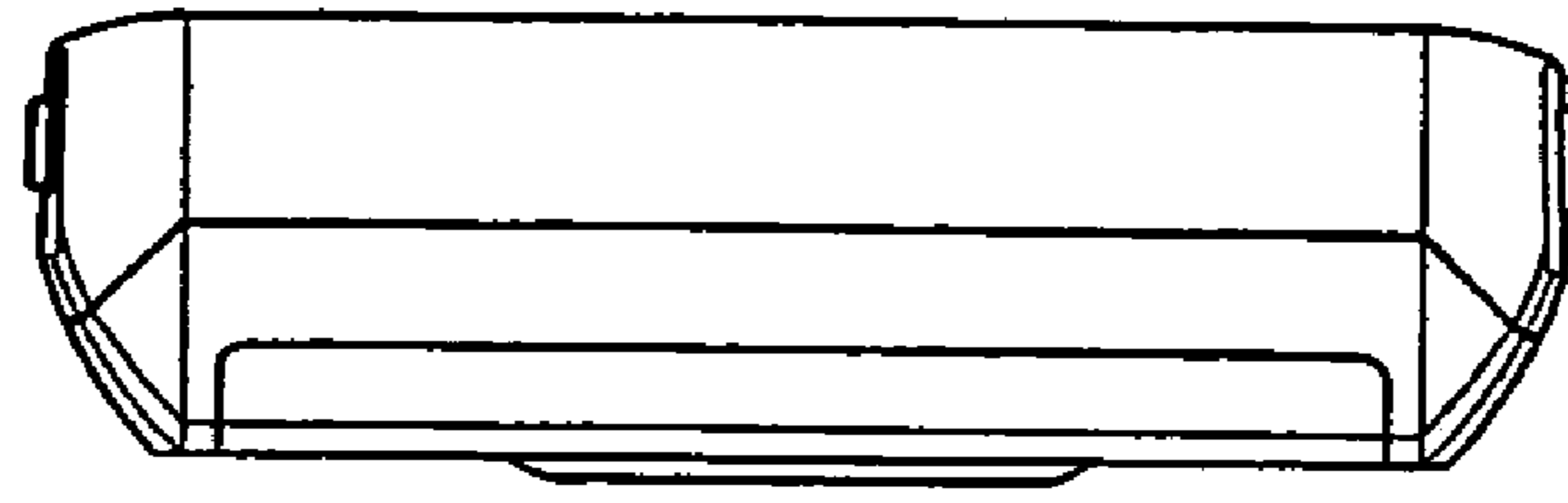

FIGURE 6

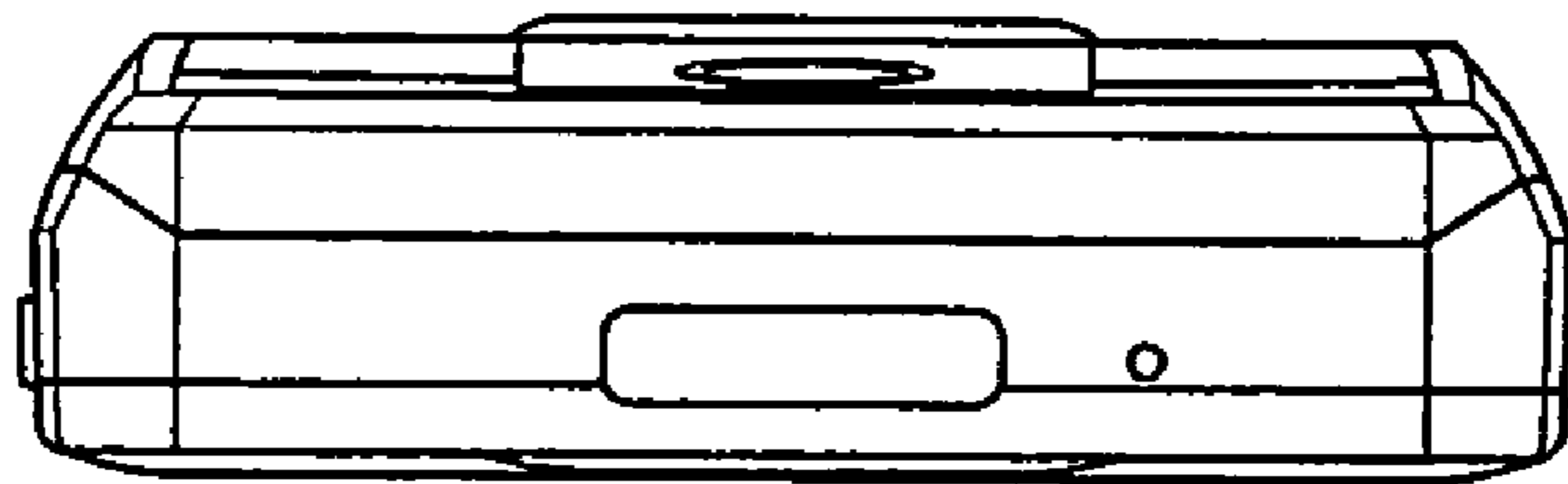

FIGURE 7

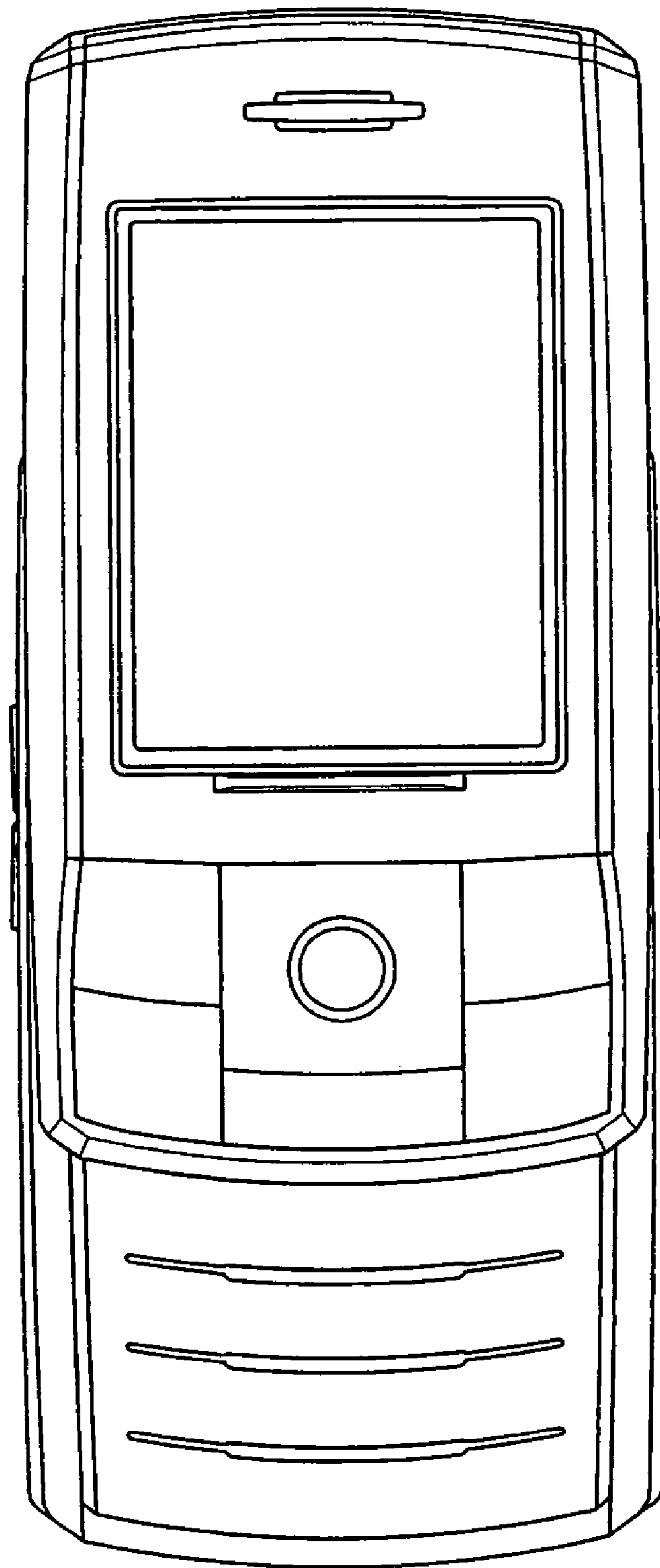

FIGURE 8

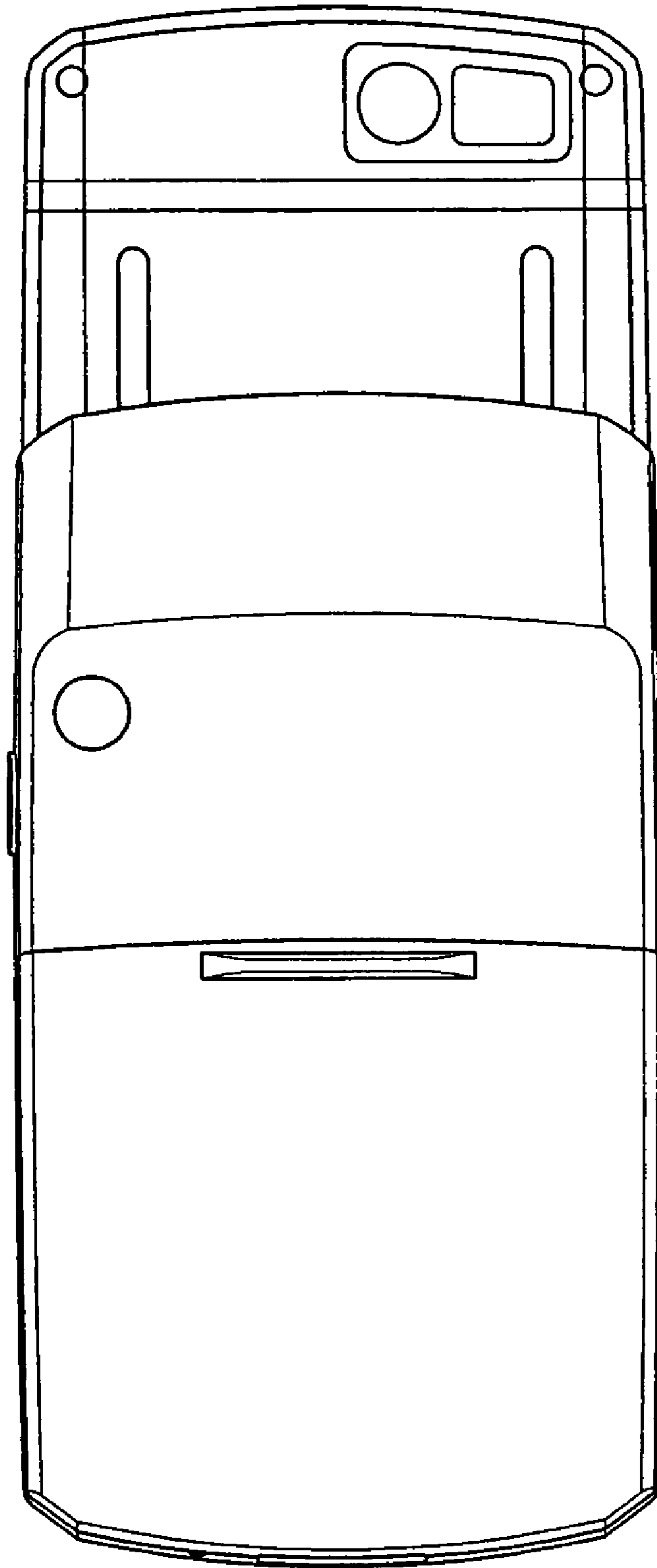

FIGURE 9