



US00D552064S

(12) **United States Design Patent**  
**Kim et al.**

(10) **Patent No.:** **US D552,064 S**

(45) **Date of Patent:** **\*\* Oct. 2, 2007**

(54) **MOBILE PHONE**

(75) Inventors: **Young-Sae Kim**, Los Altos, CA (US);  
**Chi-Young Ahn**, Seoul (KR);  
**Young-Ju Yeo**, Seoul (KR);  
**Chang-Hwan Hwang**, Goyang-si (KR)

(73) Assignee: **Samsung Electronics Co., Ltd.**,  
Suwon-Si (KR)

(\*\*) Term: **14 Years**

(21) Appl. No.: **29/243,536**

(22) Filed: **Nov. 28, 2005**

(30) **Foreign Application Priority Data**

Jun. 27, 2005 (KR) ..... 30-2005-0021407

(51) **LOC (8) Cl.** ..... **14-03**

(52) **U.S. Cl.** ..... **D14/138**

(58) **Field of Classification Search** ..... D14/138,  
D14/341-347, 147-148, 496; 379/433.01-433.13;  
455/575.3, 566, 575.1, 556.1, 556.2, 90.3  
See application file for complete search history.

(56) **References Cited**

**U.S. PATENT DOCUMENTS**

D450,046 S *	11/2001	Chun	.....	D14/138
D489,699 S *	5/2004	Hwang et al.	.....	D14/138
D493,439 S *	7/2004	Hong et al.	.....	D14/138
D496,020 S *	9/2004	Lee	.....	D14/138
D497,891 S *	11/2004	Peng et al.	.....	D14/138
D499,390 S *	12/2004	Cho	.....	D14/138
D501,455 S *	2/2005	Hunt et al.	.....	D14/138
D501,838 S *	2/2005	Kim et al.	.....	D14/138
D508,238 S *	8/2005	Kim et al.	.....	D14/138
D511,336 S *	11/2005	Kim et al.	.....	D14/138
D511,509 S *	11/2005	Kim et al.	.....	D14/138
D512,395 S *	12/2005	Kim et al.	.....	D14/138
D512,398 S *	12/2005	Chen et al.	.....	D14/138
D518,807 S *	4/2006	Choi et al.	.....	D14/138
D518,812 S *	4/2006	Kim et al.	.....	D14/138

D520,980 S *	5/2006	Taniyama et al.	.....	D14/138
D522,483 S *	6/2006	Shin	.....	D14/138
D534,908 S *	1/2007	Lee	.....	D14/346
7,174,195 B2 *	2/2007	Nagamine	.....	455/575.1
2002/0173340 A1 *	11/2002	Watanabe	.....	455/556
2003/0013417 A1 *	1/2003	Bum	.....	455/90
2003/0144036 A1 *	7/2003	Ito	.....	455/566
2003/0153283 A1 *	8/2003	Kuwazoe	.....	455/90
2003/0223576 A1 *	12/2003	Totani	.....	379/433.04
2004/0203527 A1 *	10/2004	Matsumoto	.....	455/90.3
2004/0224732 A1 *	11/2004	Lee et al.	.....	455/575.3
2004/0242280 A1 *	12/2004	Hama	.....	455/566
2005/0124392 A1 *	6/2005	Jeong	.....	455/575.1
2006/0222174 A1 *	10/2006	Kang et al.	.....	379/433.07

**OTHER PUBLICATIONS**

Samsung D830 telephone, announced Jun. 2006, [online], [retrieved on Mar. 16, 2007]. Retrieved from Internet , <URL: <http://www.gsmarena.com>>.\*

(Continued)

*Primary Examiner*—Jeffrey Asch  
(74) *Attorney, Agent, or Firm*—Staas & Halsey LLP

(57) **CLAIM**

The ornamental design for the mobile phone, as shown and described.

**DESCRIPTION**

FIG. 1 is a perspective view of the mobile phone showing our design;  
FIG. 2 is a front view thereof;  
FIG. 3 is a rear view thereof;  
FIG. 4 is a left side view thereof;  
FIG. 5 is a right side view thereof;  
FIG. 6 is a top plan view thereof; and  
FIG. 7 is a bottom plan view thereof; and,  
FIG. 8 is a perspective, open view, thereof.

**1 Claim, 3 Drawing Sheets**

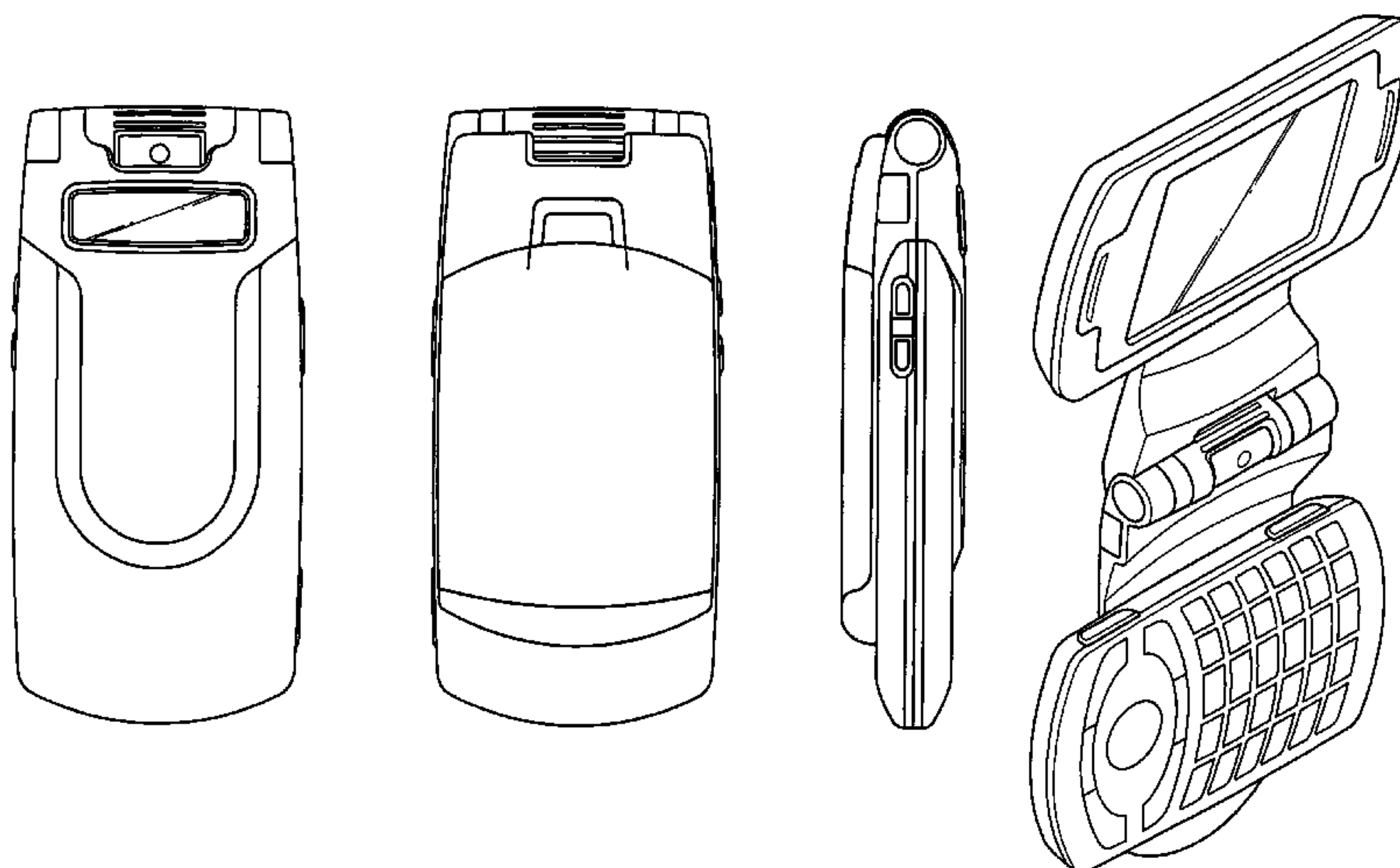

OTHER PUBLICATIONS

Samsung P910 telephone, announced Feb. 2006, [online], [retrieved on Mar. 5, 2007]. Retrieved from Internet , <URL: <http://www.gsmarena.com>>.\*

Samsung P920 telephone, announced 2<sup>nd</sup> quarter 2006, [online], [retrieved on Mar. 5, 2007]. Retrieved from Internet , <URL: <http://www.gsmarena.com>>.\*

\* cited by examiner

FIG. 1

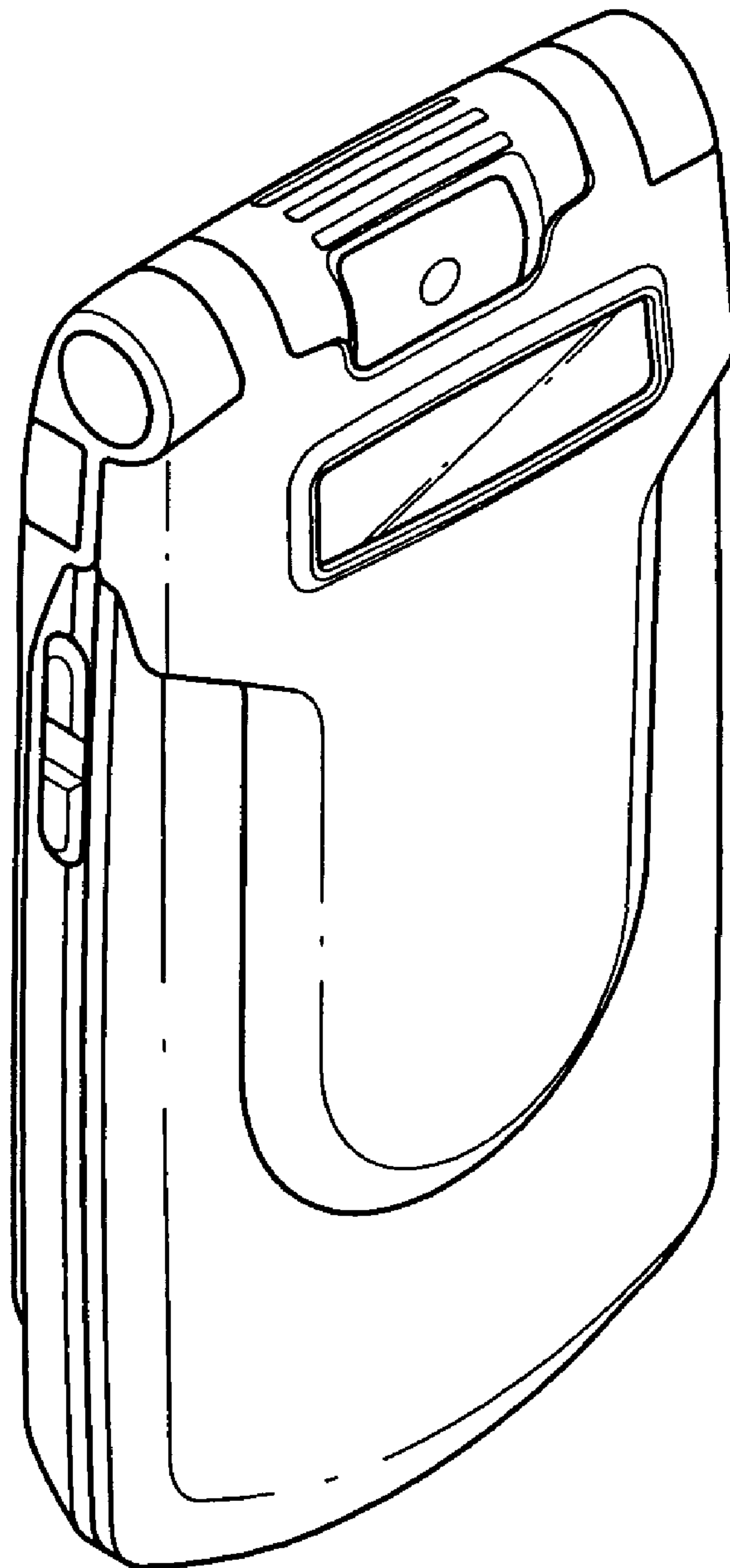

FIG. 2

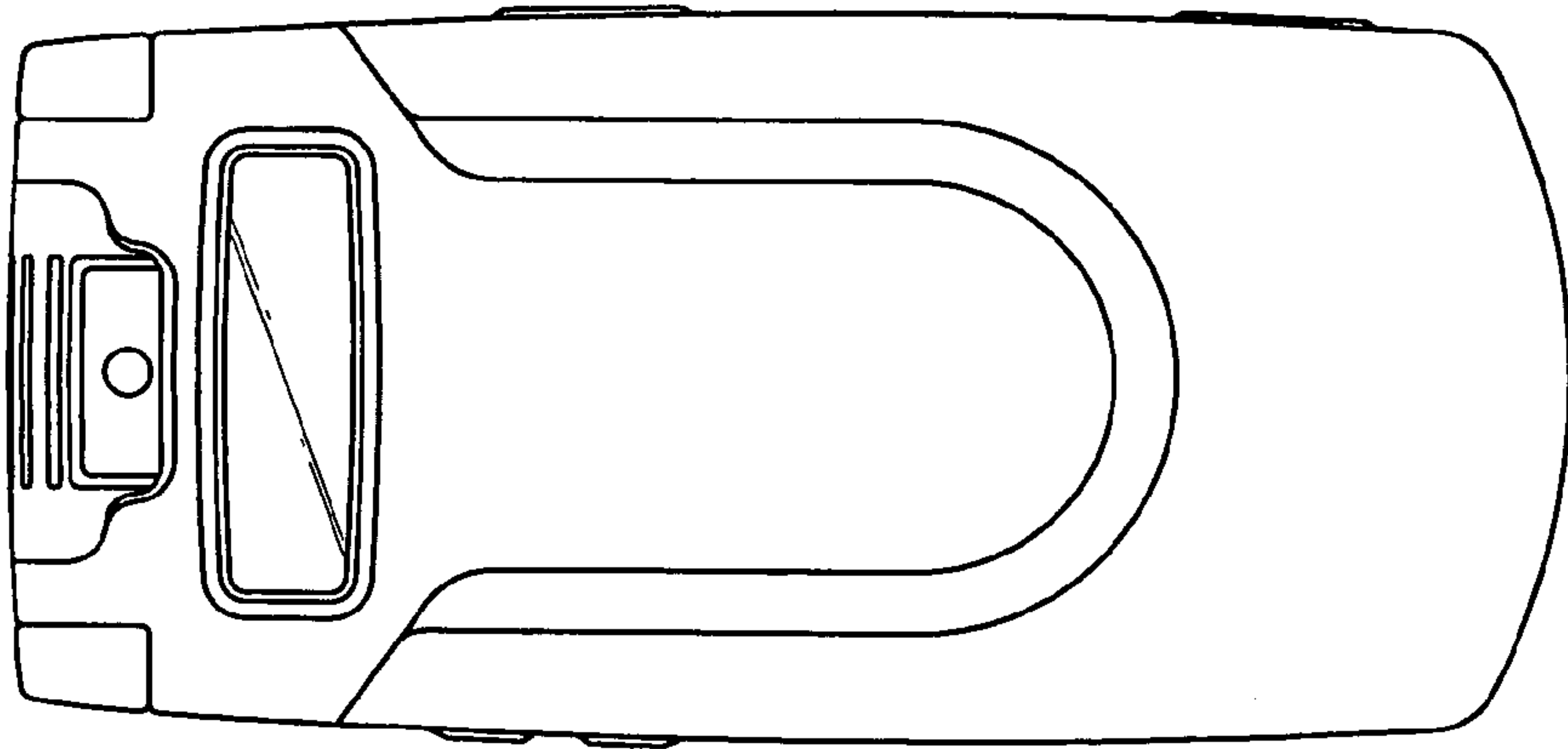

FIG. 3

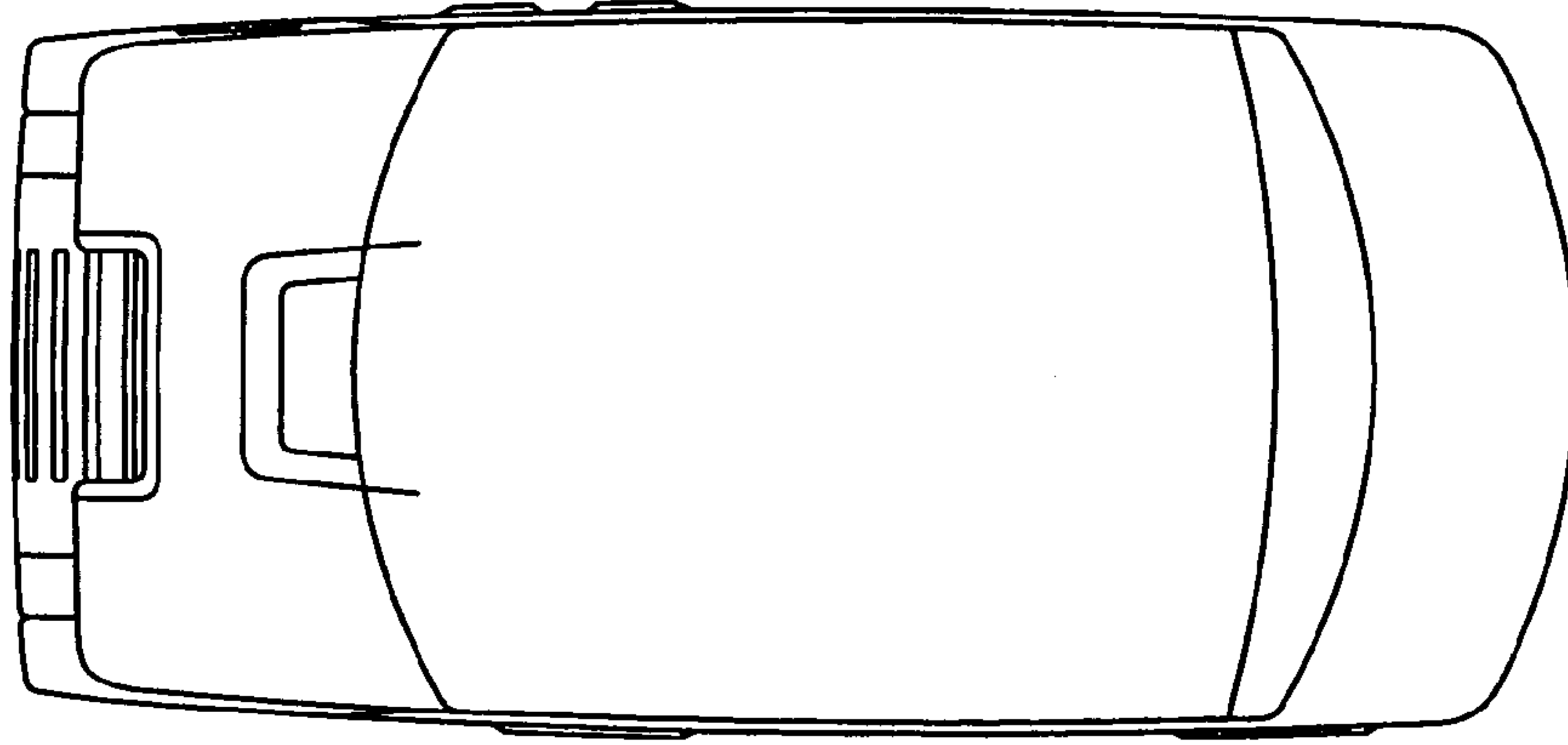

FIG. 4

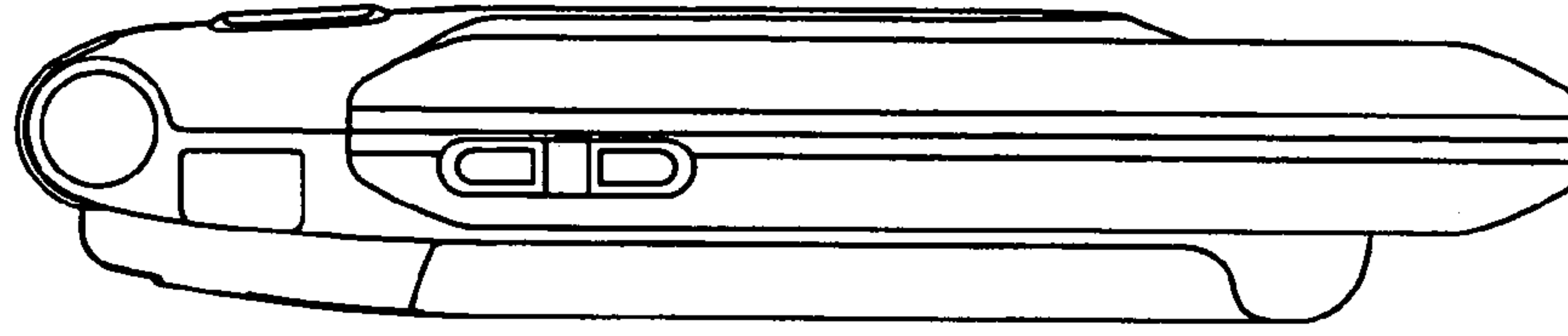

FIG. 5

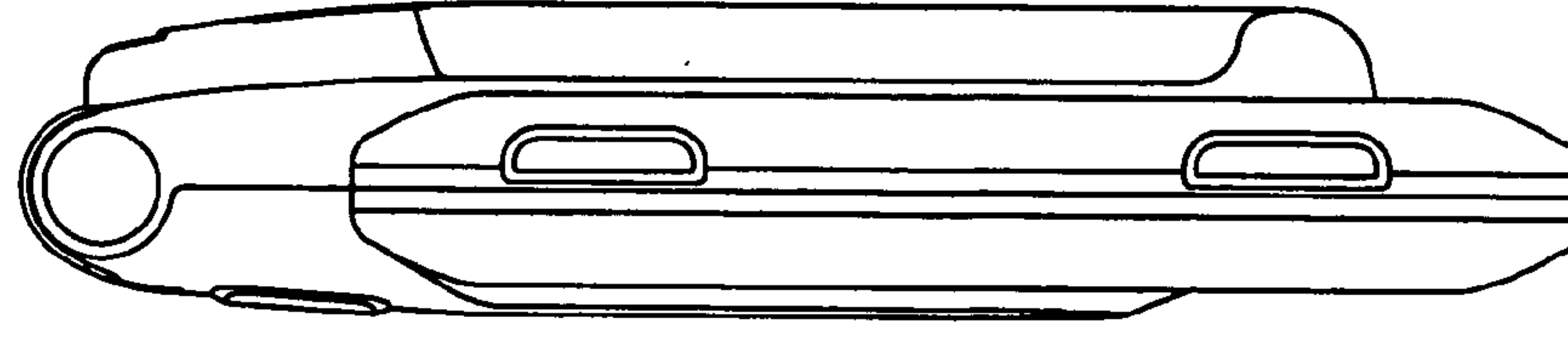

FIG. 6

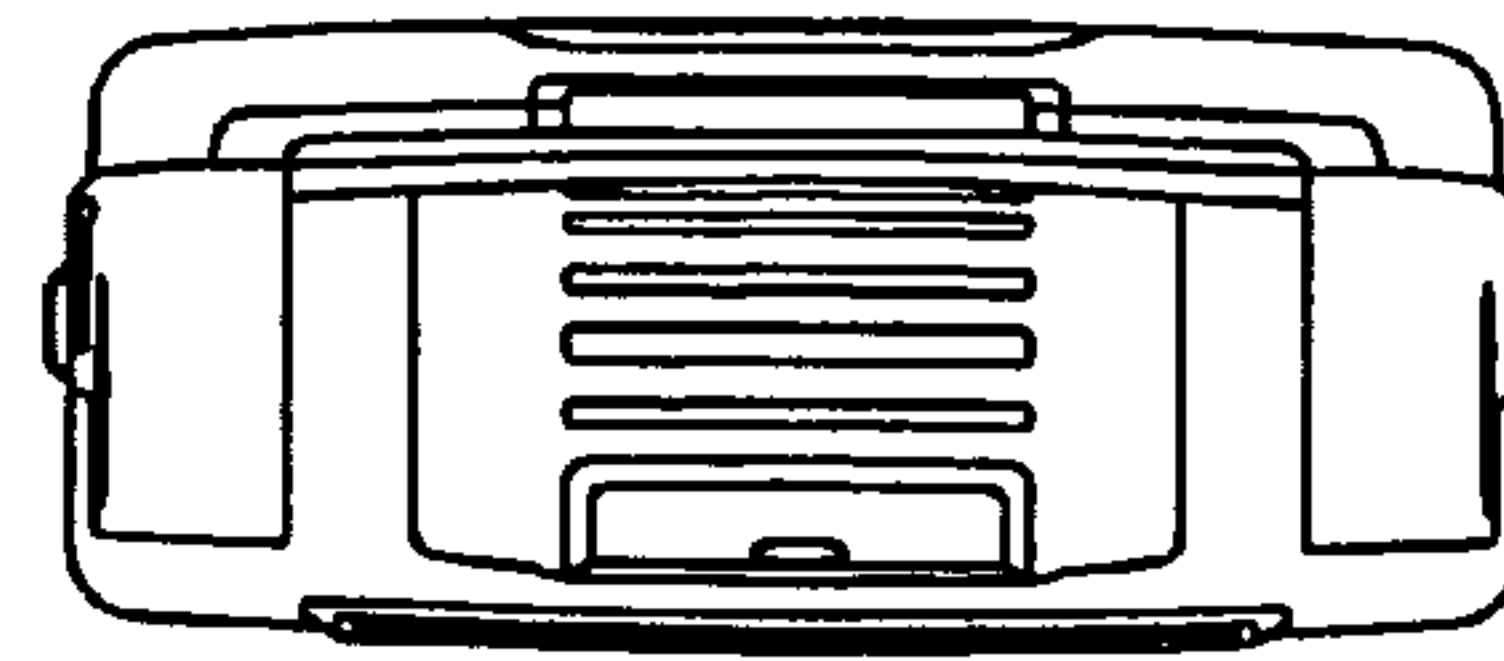

FIG. 7

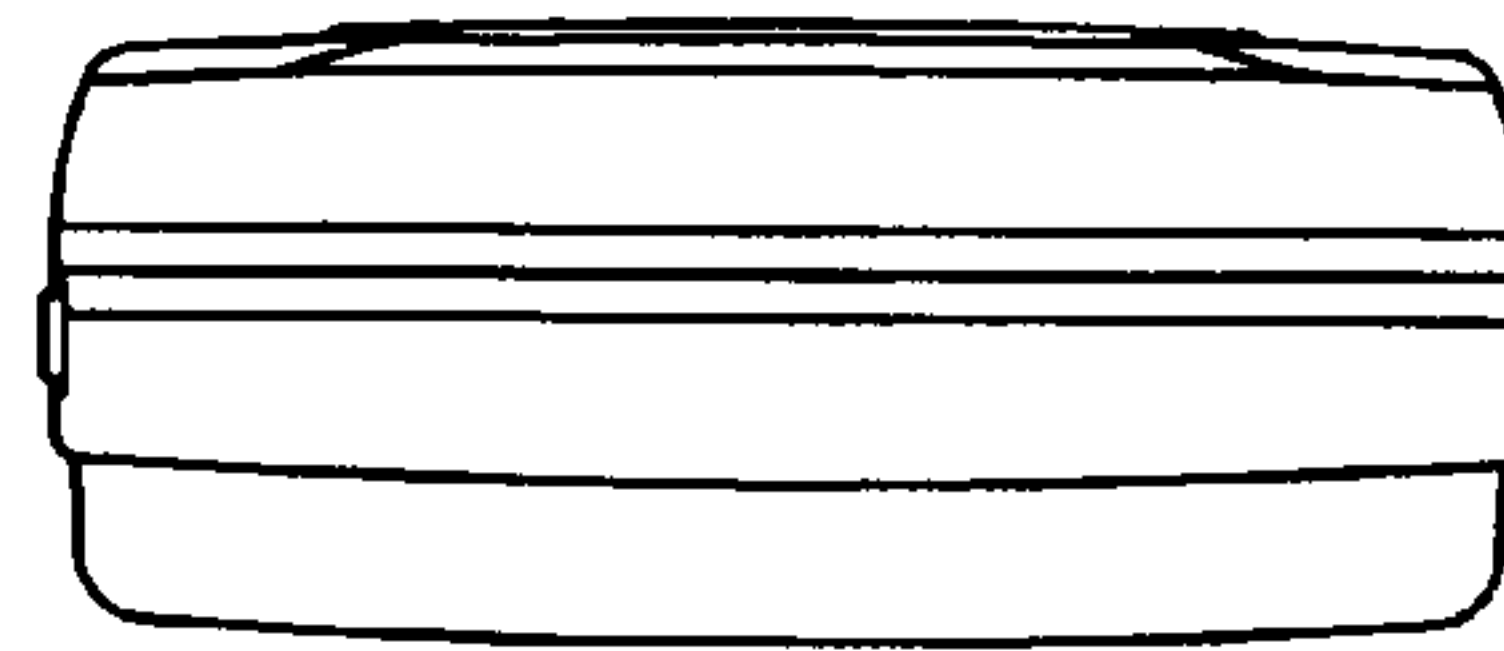

FIG. 8

