



US00D551927S

(12) **United States Design Patent**
Vagnby

(10) **Patent No.:** **US D551,927 S**

(45) **Date of Patent:** **** Oct. 2, 2007**

(54) **CAN OPENER**

(75) Inventor: **Marcus Vagnby, København V (DK)**

(73) Assignee: **Union Lucky Industrial Limited,**
Kwun Tong, Kowloon (HK)

(**) Term: **14 Years**

(21) Appl. No.: **29/263,102**

(22) Filed: **Jul. 17, 2006**

(51) **LOC (8) Cl.** **07-99**

(52) **U.S. Cl.** **D8/41**

(58) **Field of Classification Search** D7/669,
D7/693; D8/14, 18, 33-41, 98; 7/151-156;
30/400-404, 409, 412, 413, 416-418, 420-427,
30/429, 433, 434; 81/3.07, 3.35-3.37, 3.4
See application file for complete search history.

(56) **References Cited**

U.S. PATENT DOCUMENTS

D341,764 S *	11/1993	Birkholz	D8/98
D392,857 S *	3/1998	Lallemand	D8/36
D421,205 S *	2/2000	Naft et al.	D8/36
D439,491 S *	3/2001	Falt	D8/98

D501,772 S *	2/2005	Overthun et al.	D8/40
D536,231 S *	2/2007	Kawasaki	D8/98
2004/0117994 A1 *	6/2004	Chang	30/400
2005/0235501 A1 *	10/2005	So	30/425
2006/0064883 A1 *	3/2006	So	30/416

* cited by examiner

Primary Examiner—Robert M. Spear

Assistant Examiner—Garth Rademaker

(74) *Attorney, Agent, or Firm*—Leydig, Voit & Mayer, Ltd.

(57) **CLAIM**

I claim the ornamental design for a can opener, as shown and described.

DESCRIPTION

FIG. 1 is a front view of a can opener according to my design;

FIG. 2 is a rear view thereof;

FIG. 3 is a left side view thereof;

FIG. 4 is a right side view thereof;

FIG. 5 is a top view thereof; and,

FIG. 6 is a bottom view thereof.

1 Claim, 3 Drawing Sheets

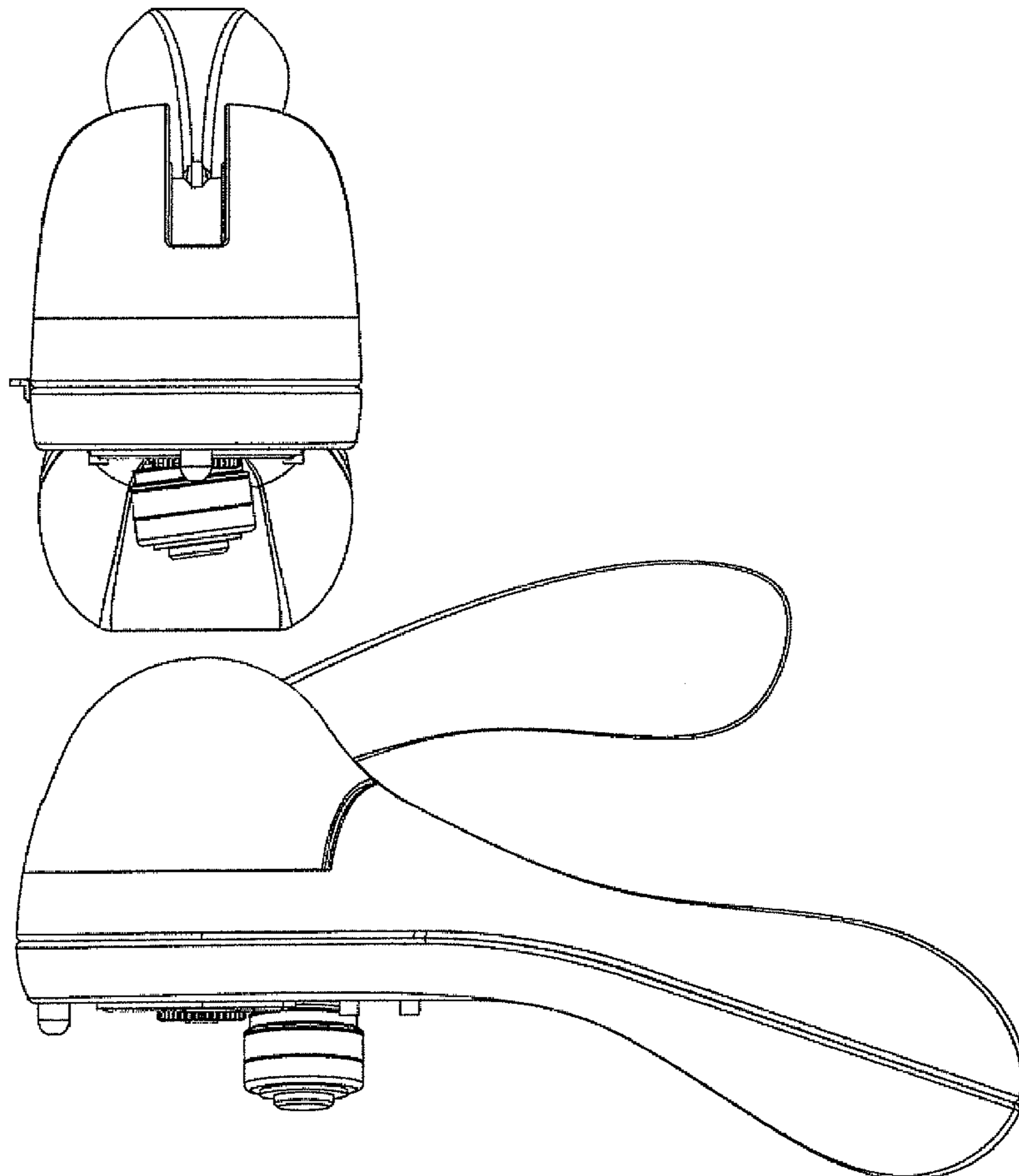

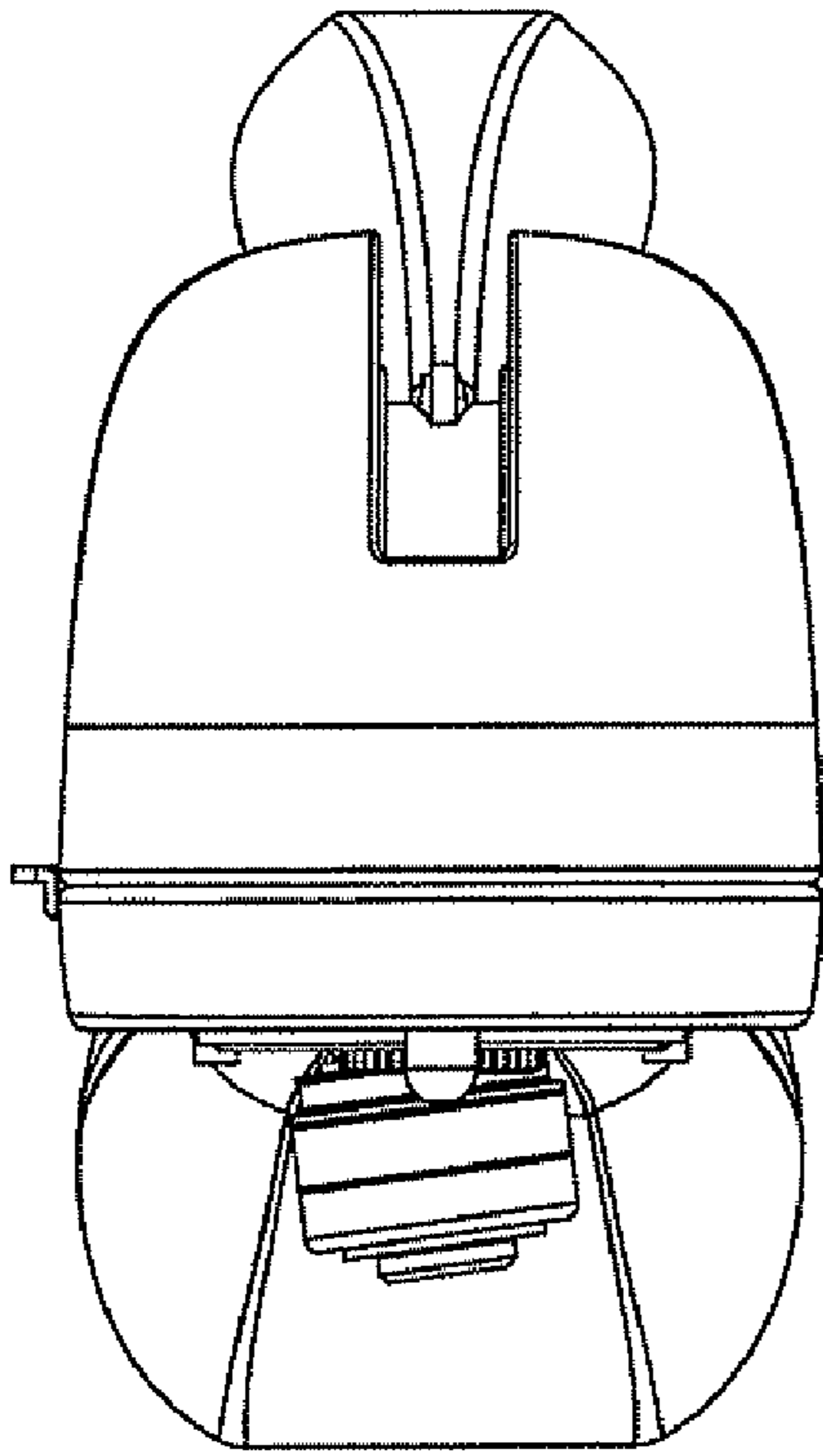

FIG. 1

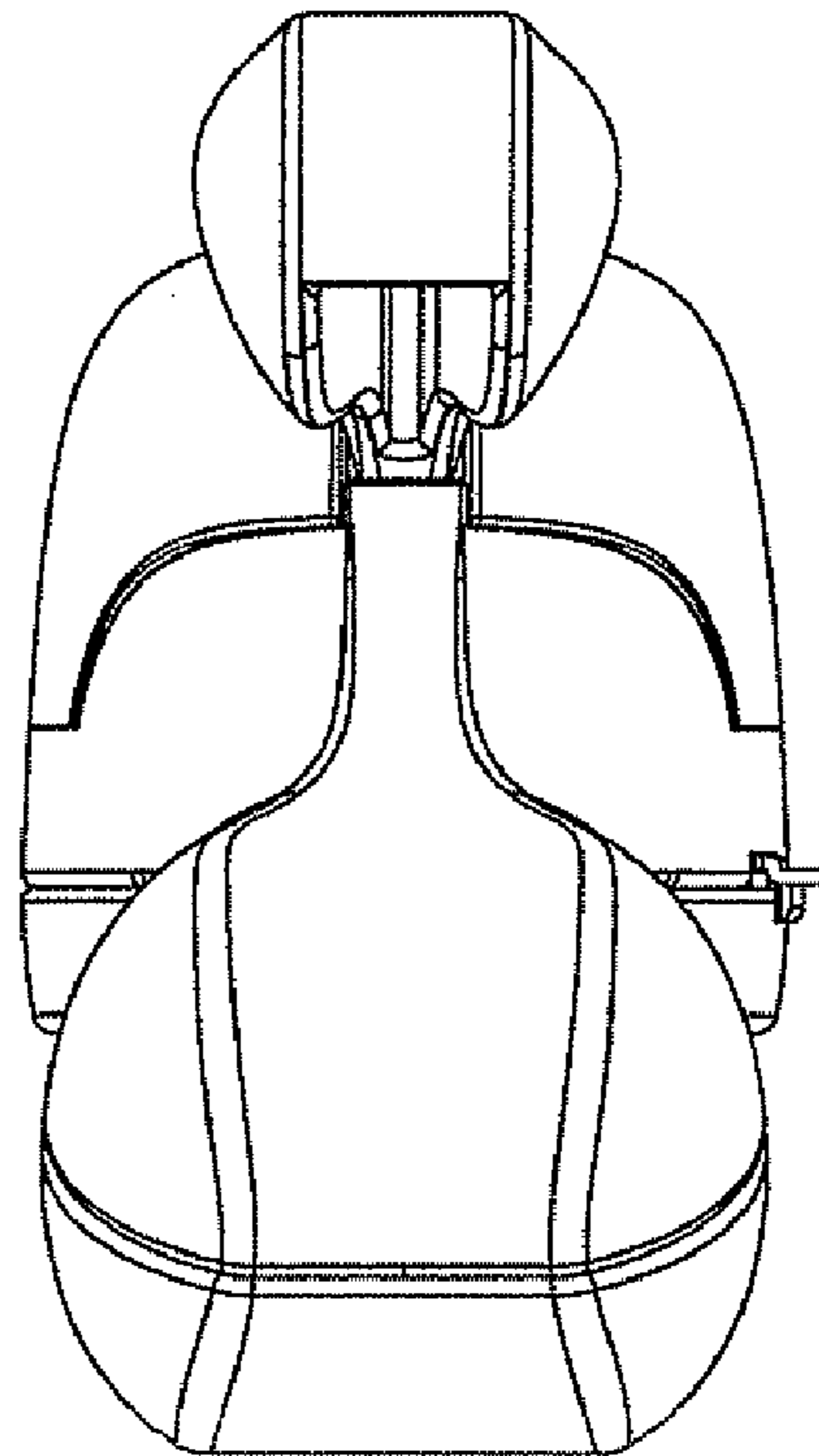

FIG. 2

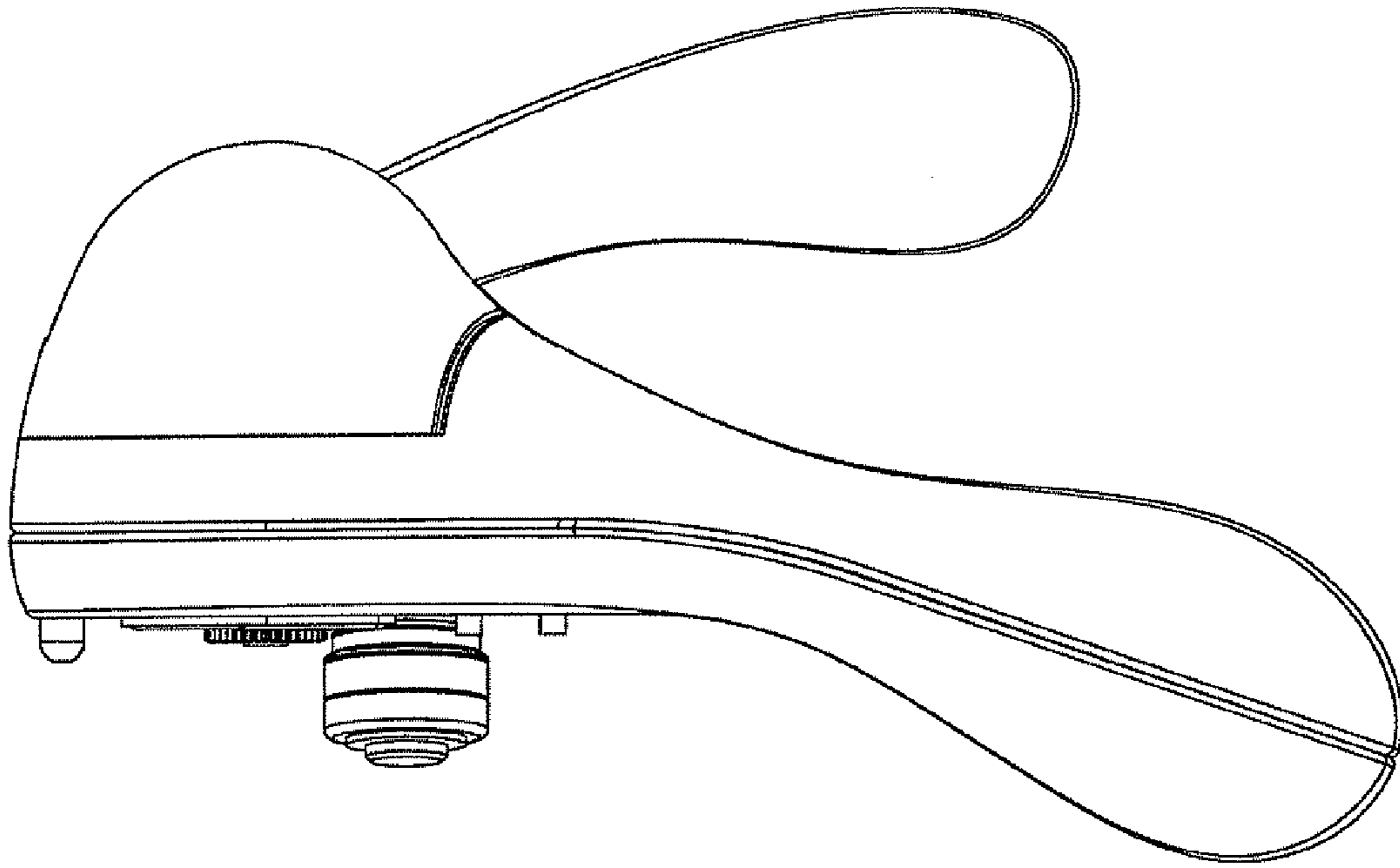

FIG. 3

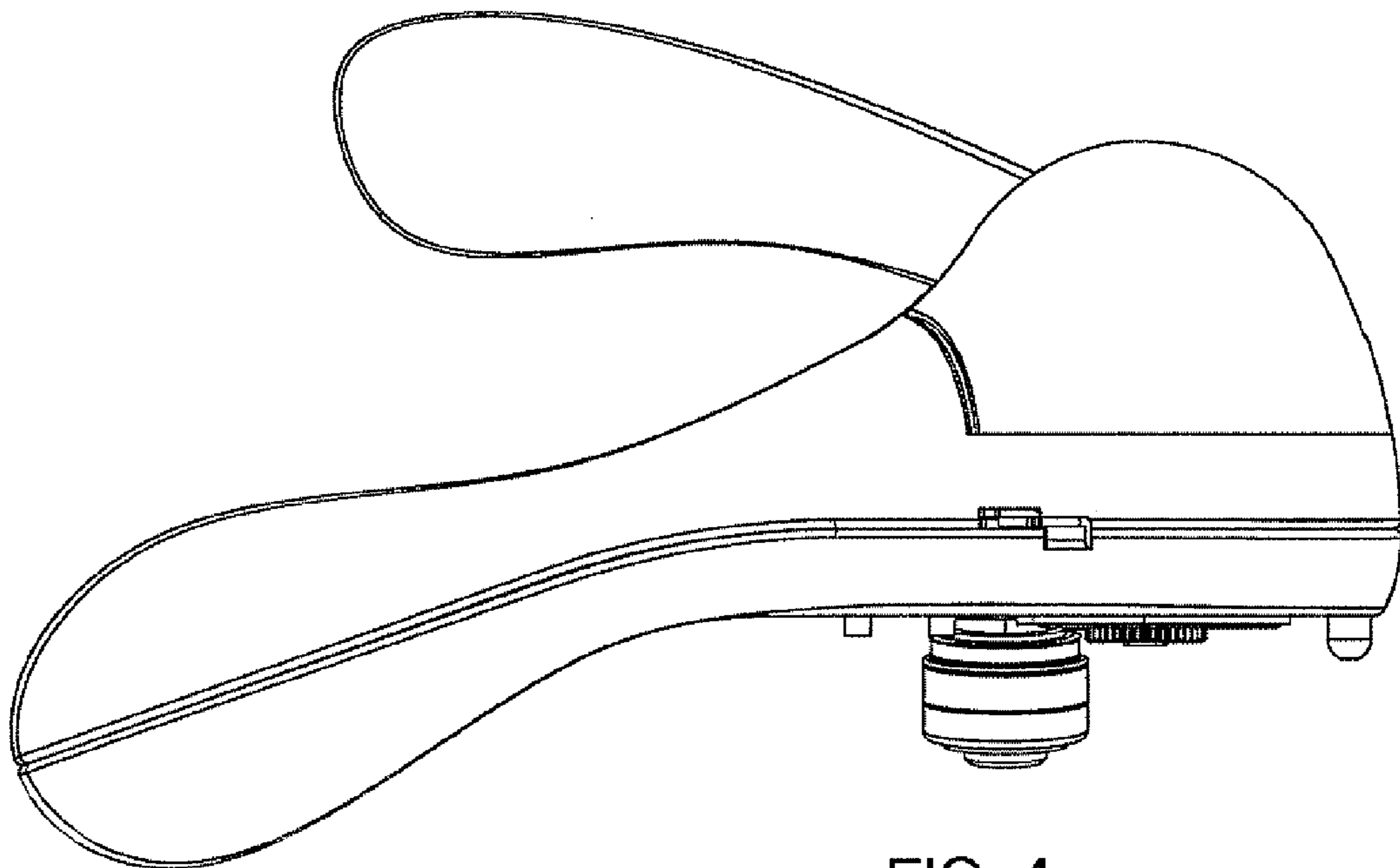

FIG. 4

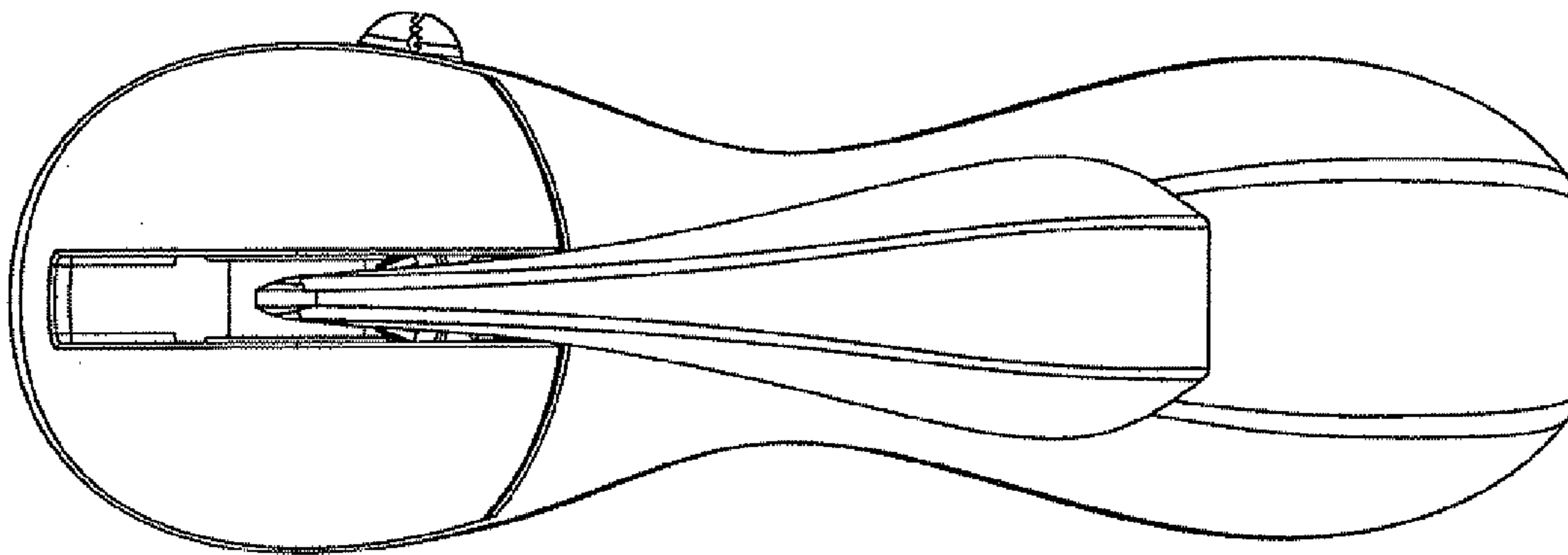

FIG. 5

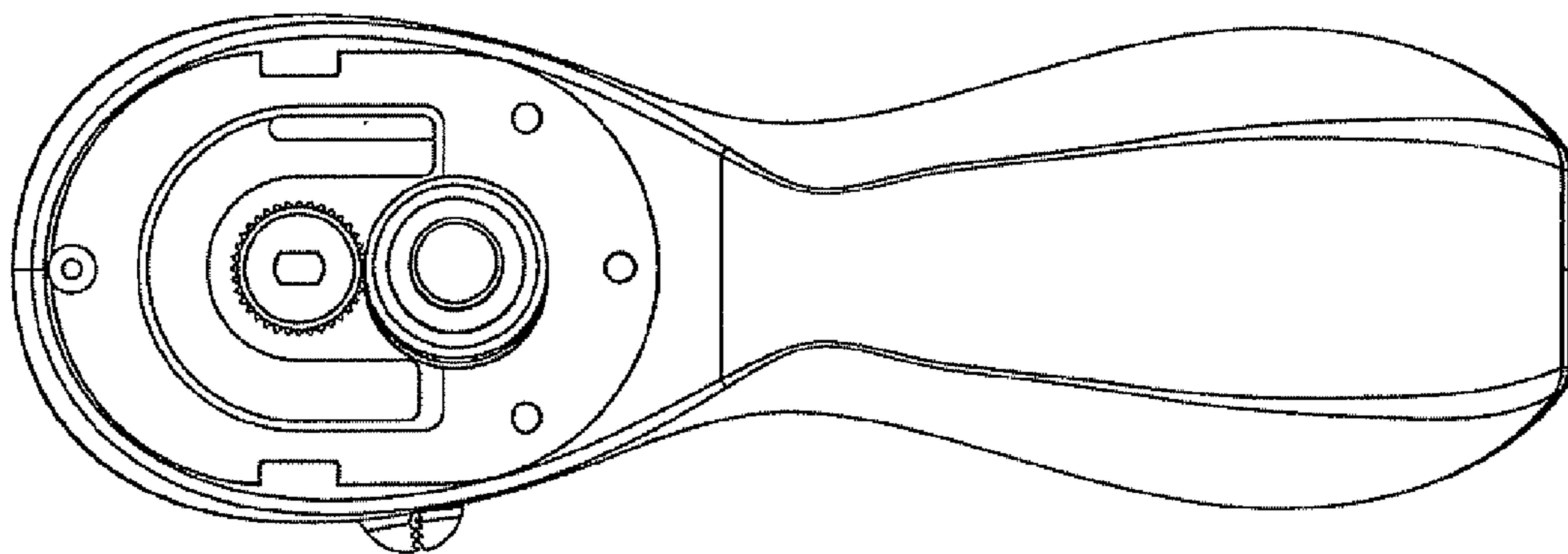

FIG. 6