



US00D551825S

(12) **United States Design Patent**
Nutting

(10) **Patent No.:** **US D551,825 S**
(45) **Date of Patent:** **** Sep. 25, 2007**

(54) **VAMPIRE FANGS COFFIN**

(76) Inventor: **Donald W. Nutting**, 1295 Ithaca Dr.,
Boulder, CO (US) 80303

(**) Term: **14 Years**

(21) Appl. No.: **29/268,446**

(22) Filed: **Nov. 6, 2006**

Related U.S. Application Data

(62) Division of application No. 29/200,844, filed on Mar.
3, 2004, now Pat. No. Des. 531,780.

(51) **LOC (8) Cl.** **99-00**

(52) **U.S. Cl.** **D99/3**

(58) **Field of Classification Search** D99/1,
D99/3, 34, 35, 37; D3/302; D11/160; D21/483;
D27/106, 110; 27/1, 2, 4, 7, 19, 14; 52/128,
52/133; 229/186

See application file for complete search history.

(56) **References Cited**

U.S. PATENT DOCUMENTS

D37,581 S * 10/1905 Ellis D27/110

(Continued)

OTHER PUBLICATIONS

Foothills Ltd 1998 Catalog.

Primary Examiner—Paula A. Greene

(74) *Attorney, Agent, or Firm*—Brian D. Smith, P.C.

(57) **CLAIM**

The ornamental design for vampire fangs coffin, as shown
and described.

DESCRIPTION

FIG. 1 is a perspective view of vampire fangs coffin showing
my new design;

FIG. 2 is a left side elevational view of the vampire fangs
coffin of FIG. 1;

FIG. 3 is a front end elevational view of the vampire fangs
coffin of FIG. 1;

FIG. 4 is a rear end elevational view of the vampire fangs
coffin of FIG. 1;

FIG. 5 is a perspective view of FIG. 1 with the lid removed;

FIG. 6 is a top plan view of the vampire fangs coffin of FIG.
1;

FIG. 7 is a bottom plan view of the vampire fangs coffin of
FIG. 1;

FIG. 8 is a perspective view of a second embodiment of a
vampire fangs coffin showing my new design in a stacked
position;

FIG. 9 is a left side elevation view of the stacked vampire
fangs coffins of FIG. 8;

FIG. 10 is a front end elevation view of the stacked vampire
fangs coffins of FIG. 8;

FIG. 11 is a rear end elevation view of the stacked vampire
fangs coffins of FIG. 8;

FIG. 12 is a perspective view of FIG. 8 with the lid removed;

FIG. 13 is a top plan view of the stacked vampire fangs
coffins of FIG. 8;

FIG. 14 is a bottom plan view of the stacked vampire fangs
coffins of FIG. 8;

FIG. 15 is a perspective view of a third embodiment of a
vampire fangs coffin in a stacked position;

FIG. 16 is a side elevation view of the stacked vampire fangs
coffins of FIG. 8;

FIG. 17 is a front end elevation view of the stacked vampire
fangs coffins of FIG. 8;

FIG. 18 is a rear end elevation view of the stacked vampire
fangs coffins of FIG. 8;

FIG. 19 is a perspective view of FIG. 8 with the lid removed;

FIG. 20 is a top plan view of the stacked vampire fangs
coffins of FIG. 8; and,

FIG. 21 is a bottom plan view of the stacked vampire fangs
coffins of FIG. 8.

1 Claim, 6 Drawing Sheets

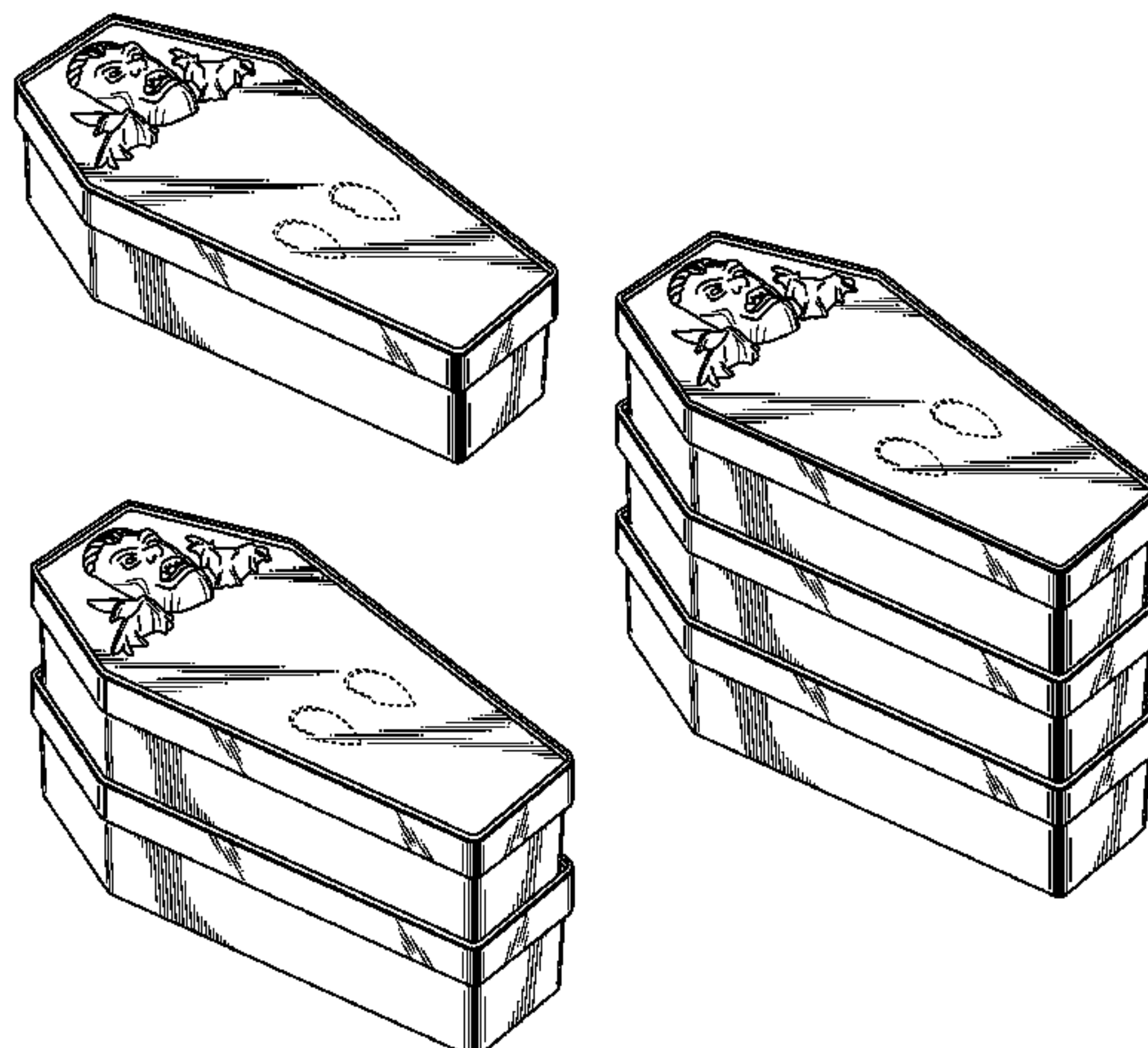

US D551,825 S

Page 2

U.S. PATENT DOCUMENTS

D199,716 S *	12/1964	Gluck	D27/106	D419,260 S	1/2000	Manzo, Jr.	
4,517,713 A *	5/1985	Swallert	27/4	D437,099 S	1/2001	Nutting et al.	
4,854,018 A *	8/1989	Von Bratt	27/19	D460,354 S	7/2002	Goldiner et al.	
4,891,869 A *	1/1990	Nutting	27/4	6,502,354 B2 *	1/2003	McClure et al.	52/133
5,111,559 A *	5/1992	Mohr et al.	27/4	D494,229 S *	8/2004	Akers	D21/483
5,307,545 A *	5/1994	Stoltz	27/4				

* cited by examiner

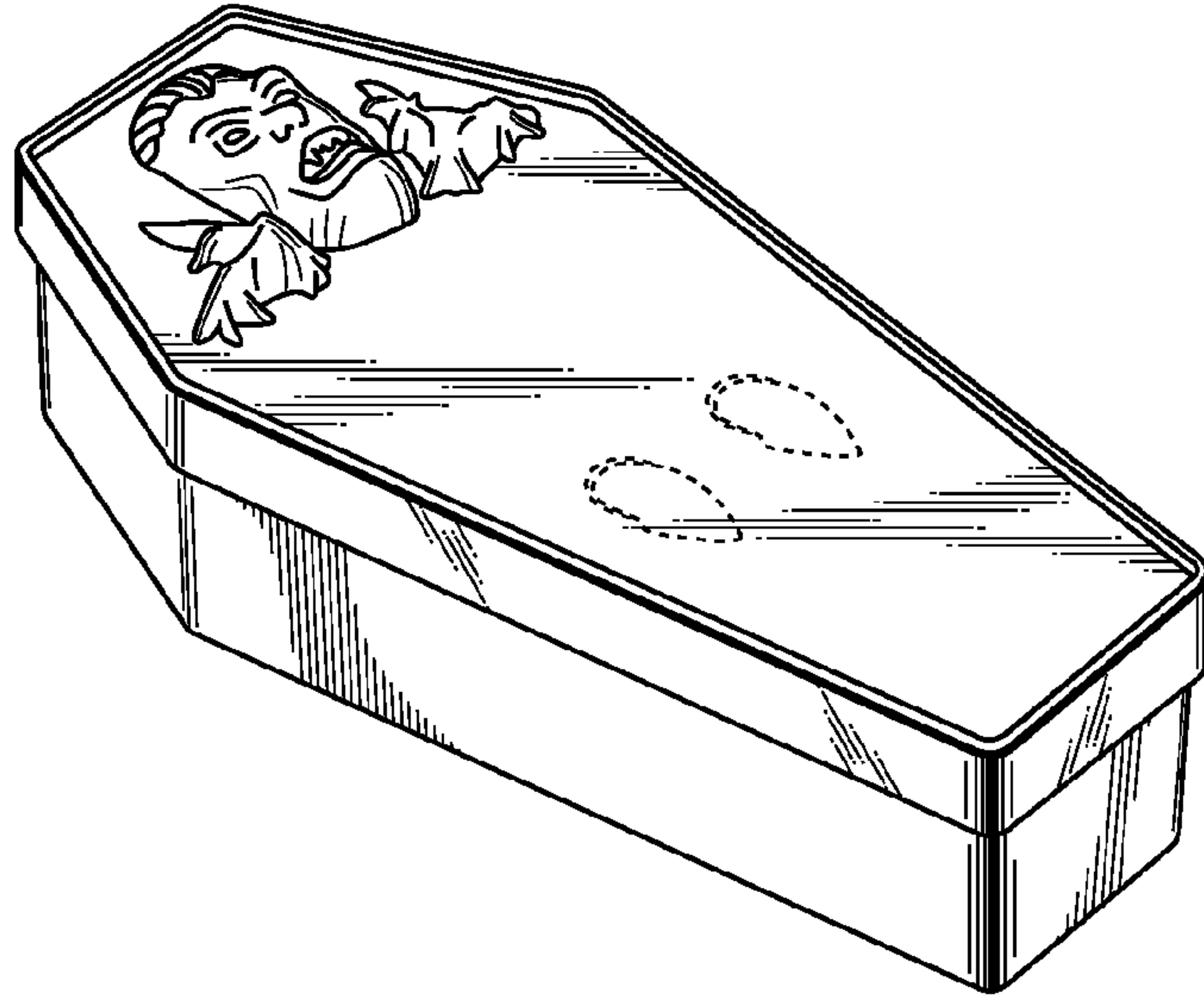

FIG. 1

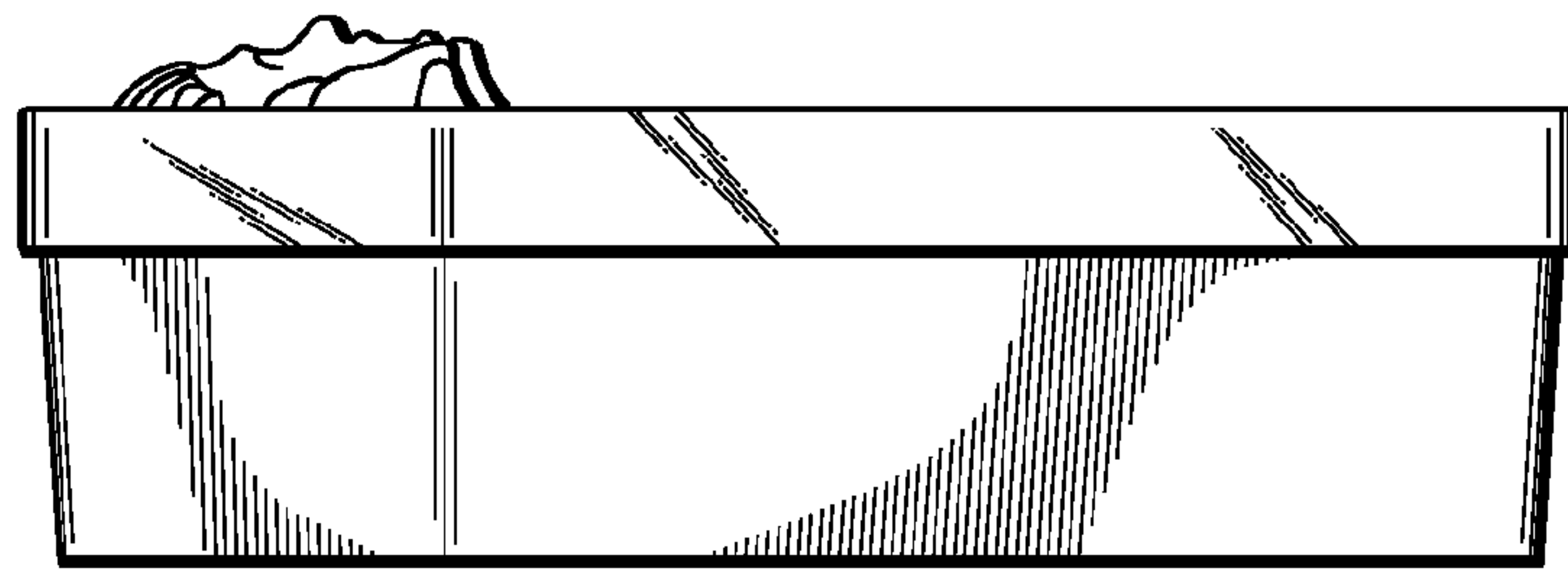

FIG. 2

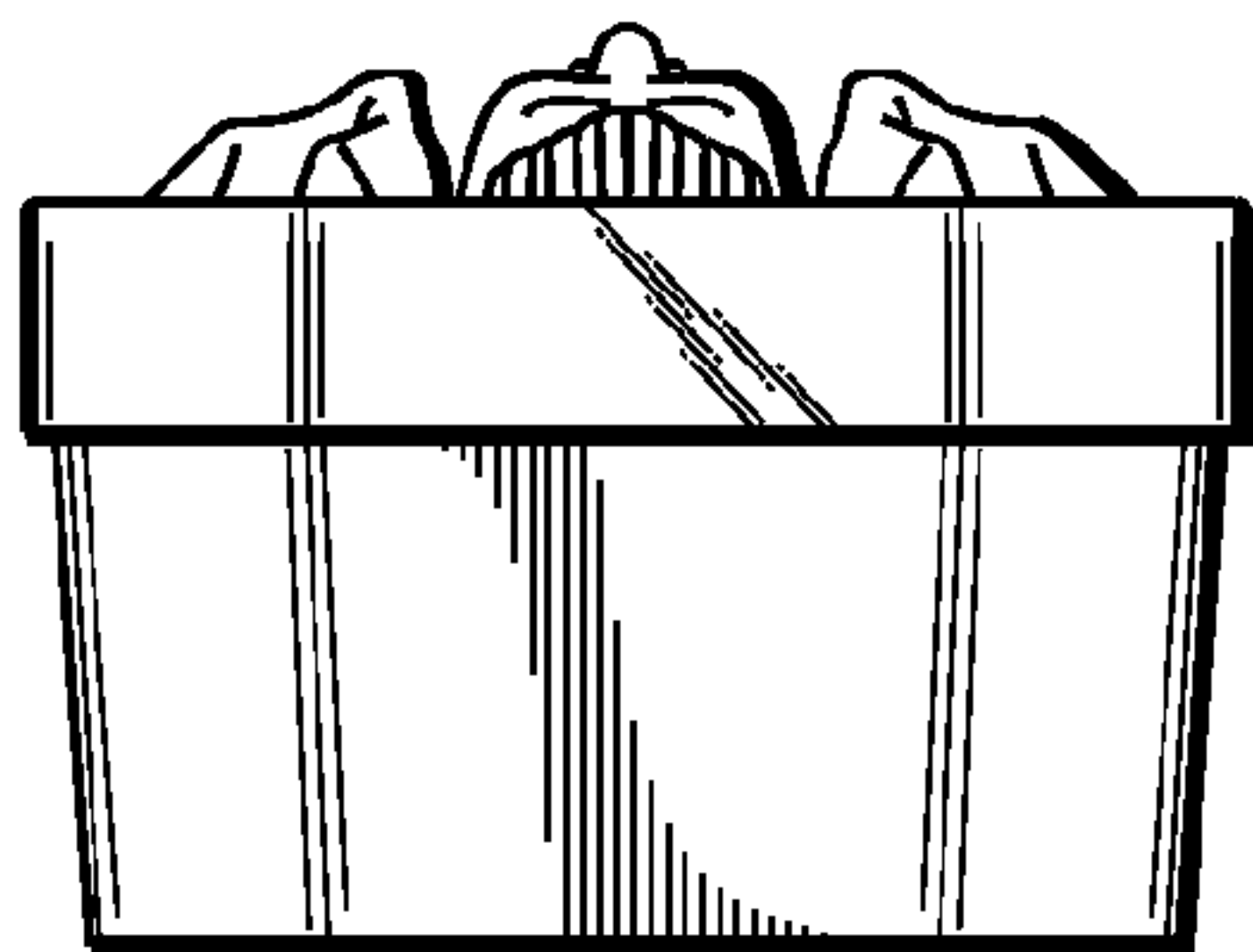

FIG. 3

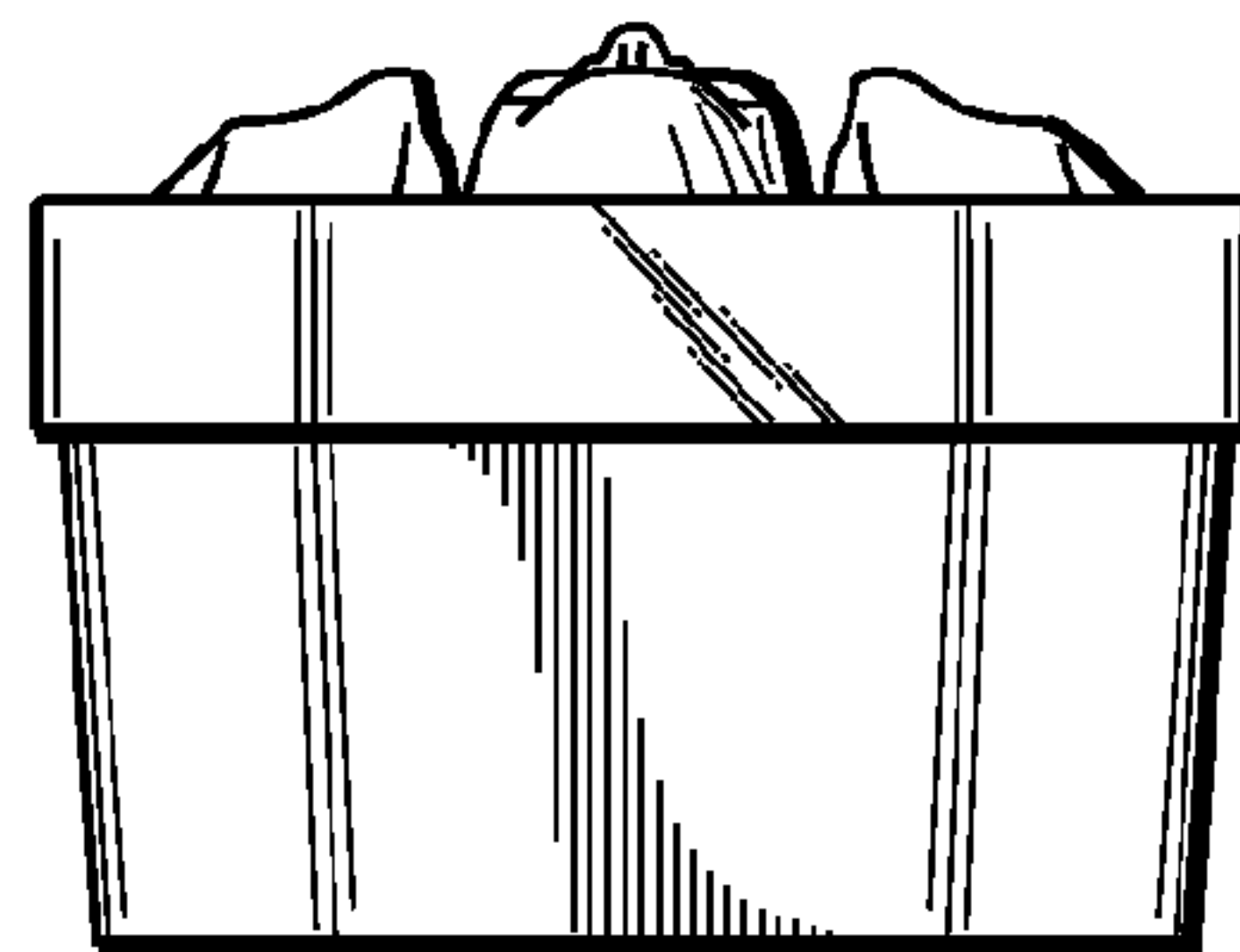

FIG. 4

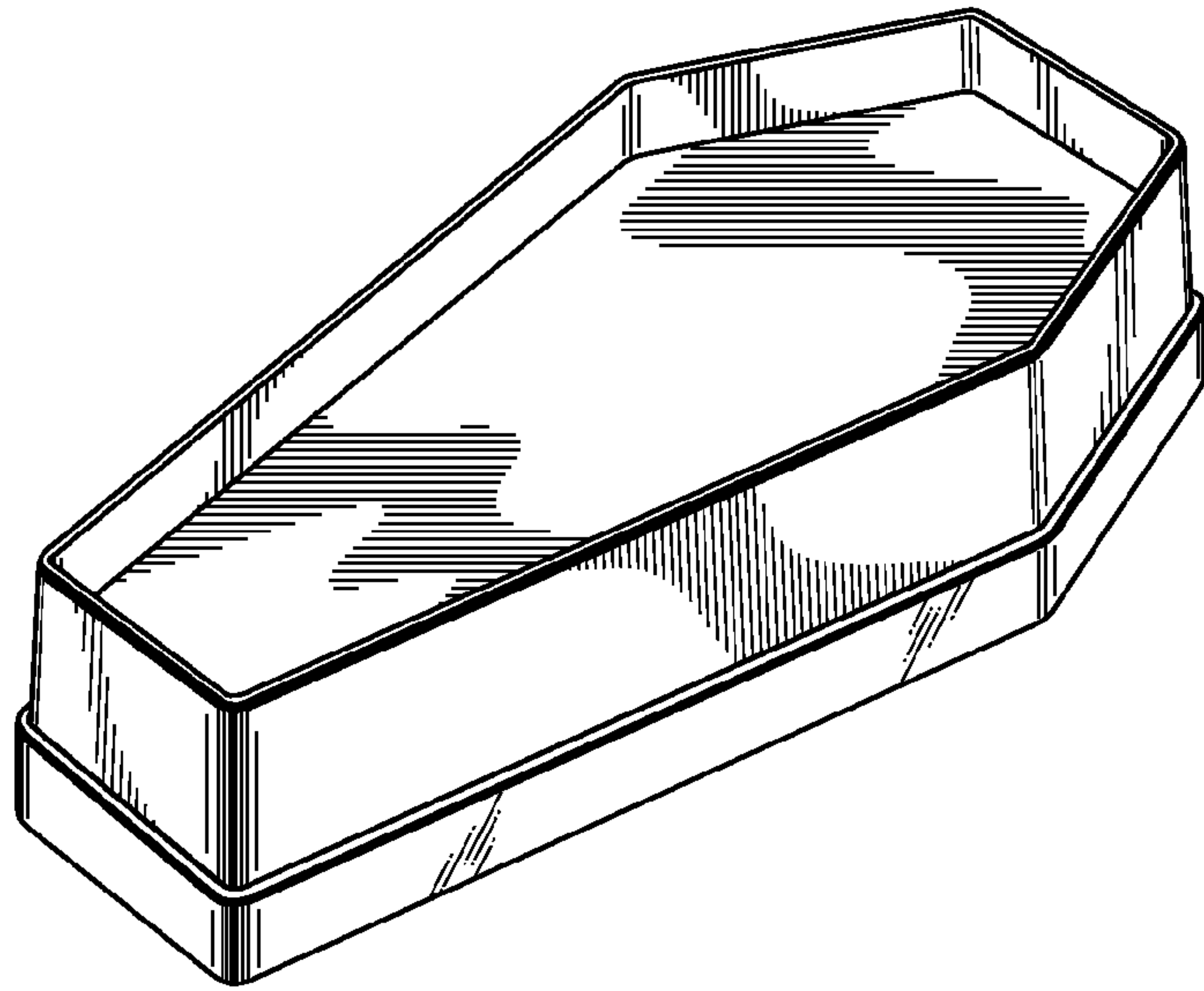

FIG. 5

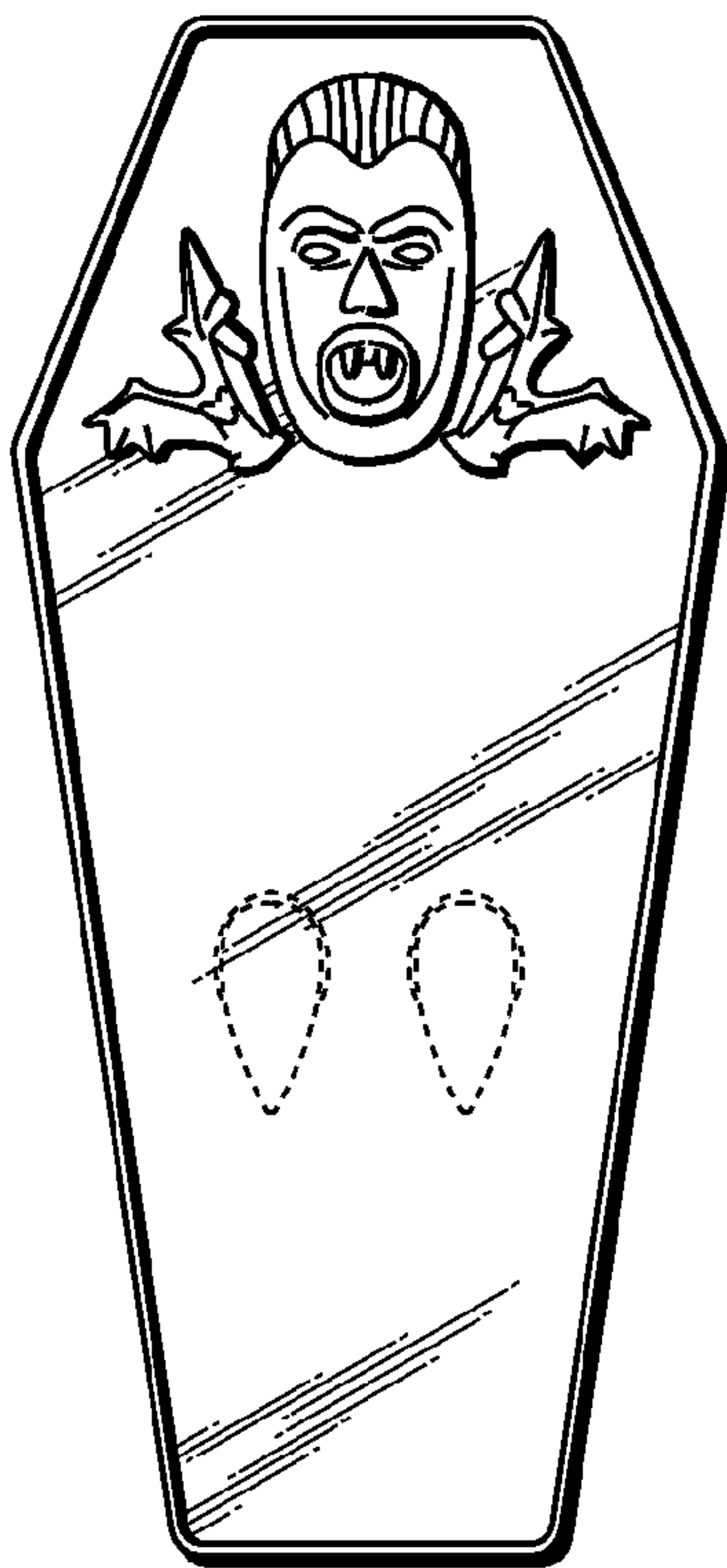

FIG. 6

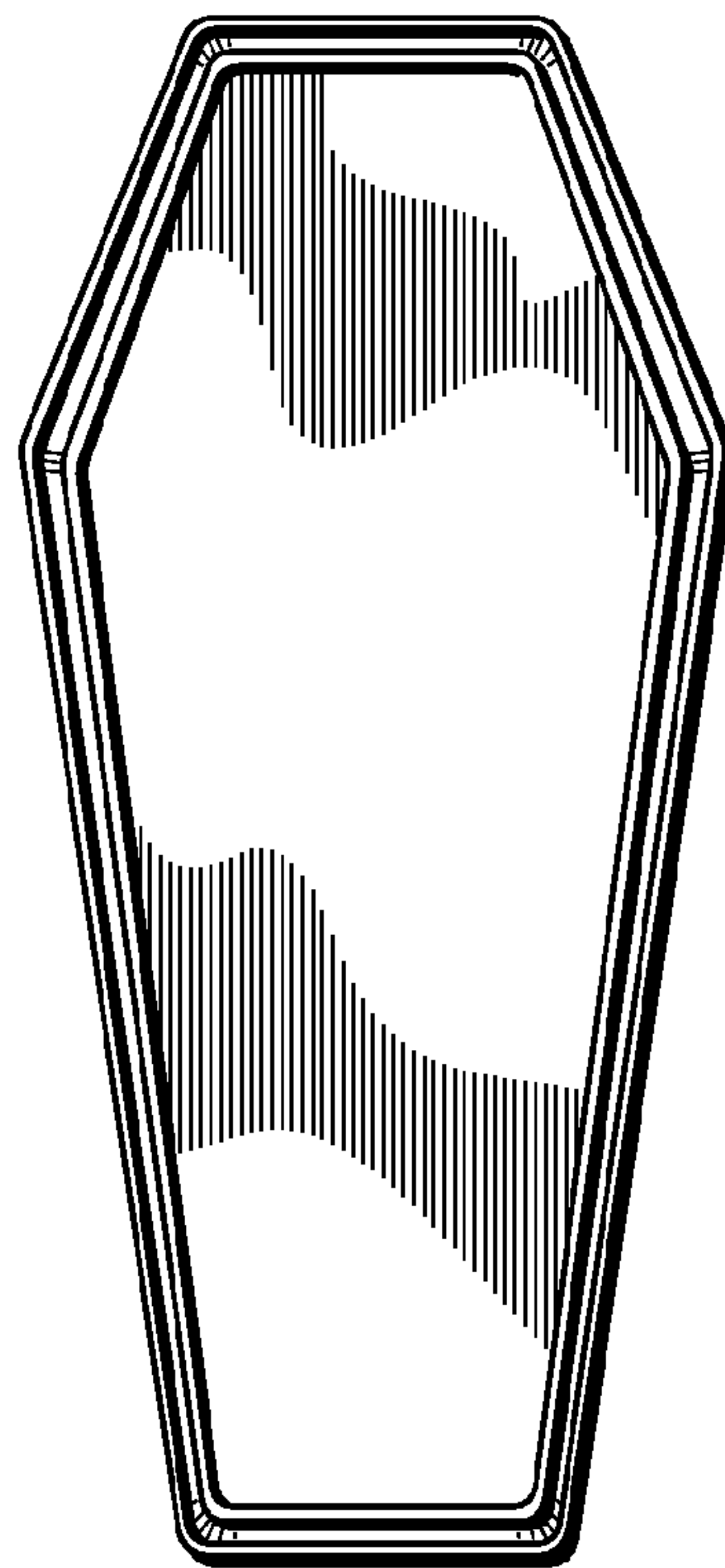

FIG. 7

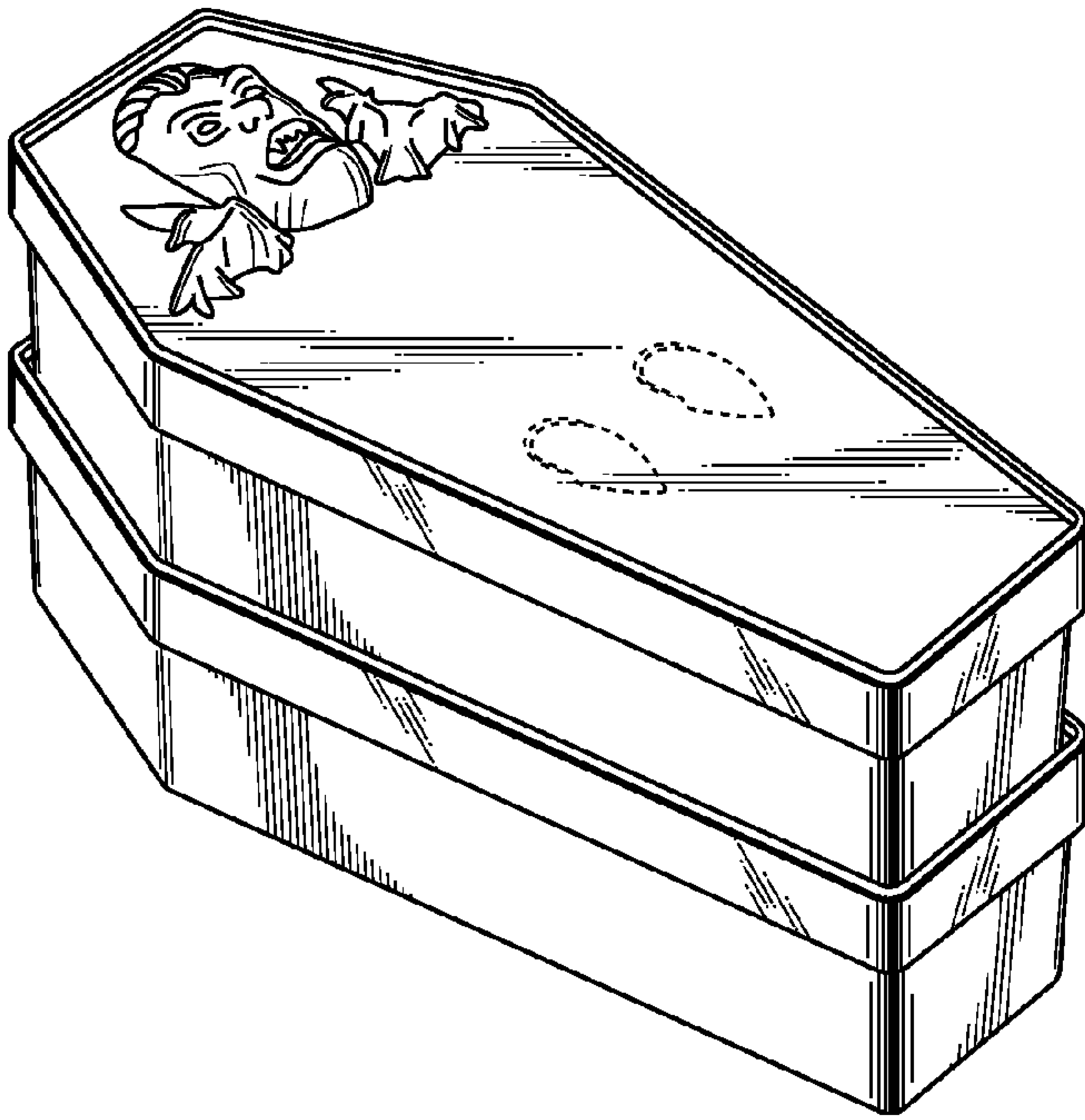

FIG. 8

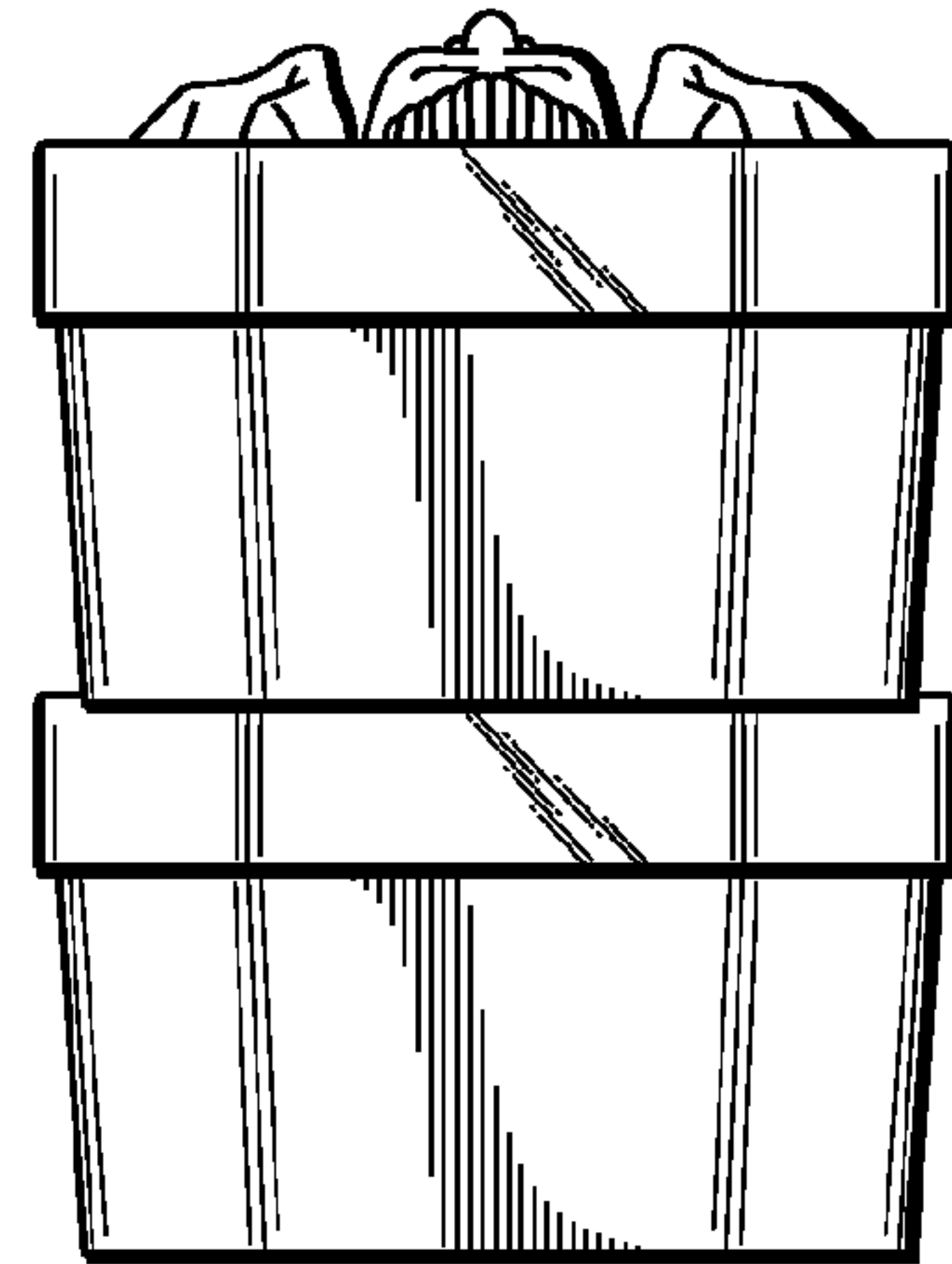

FIG. 10

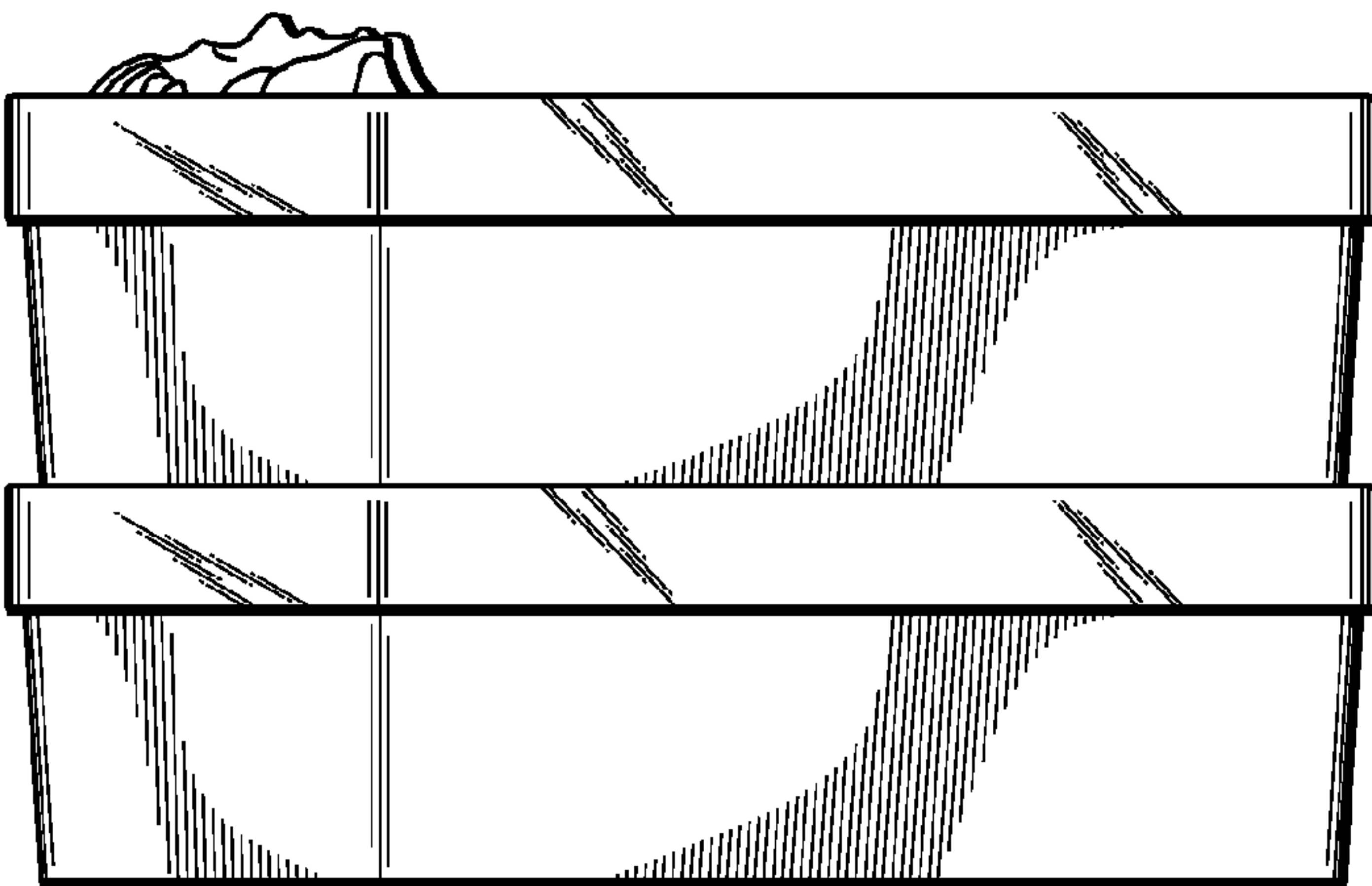

FIG. 9

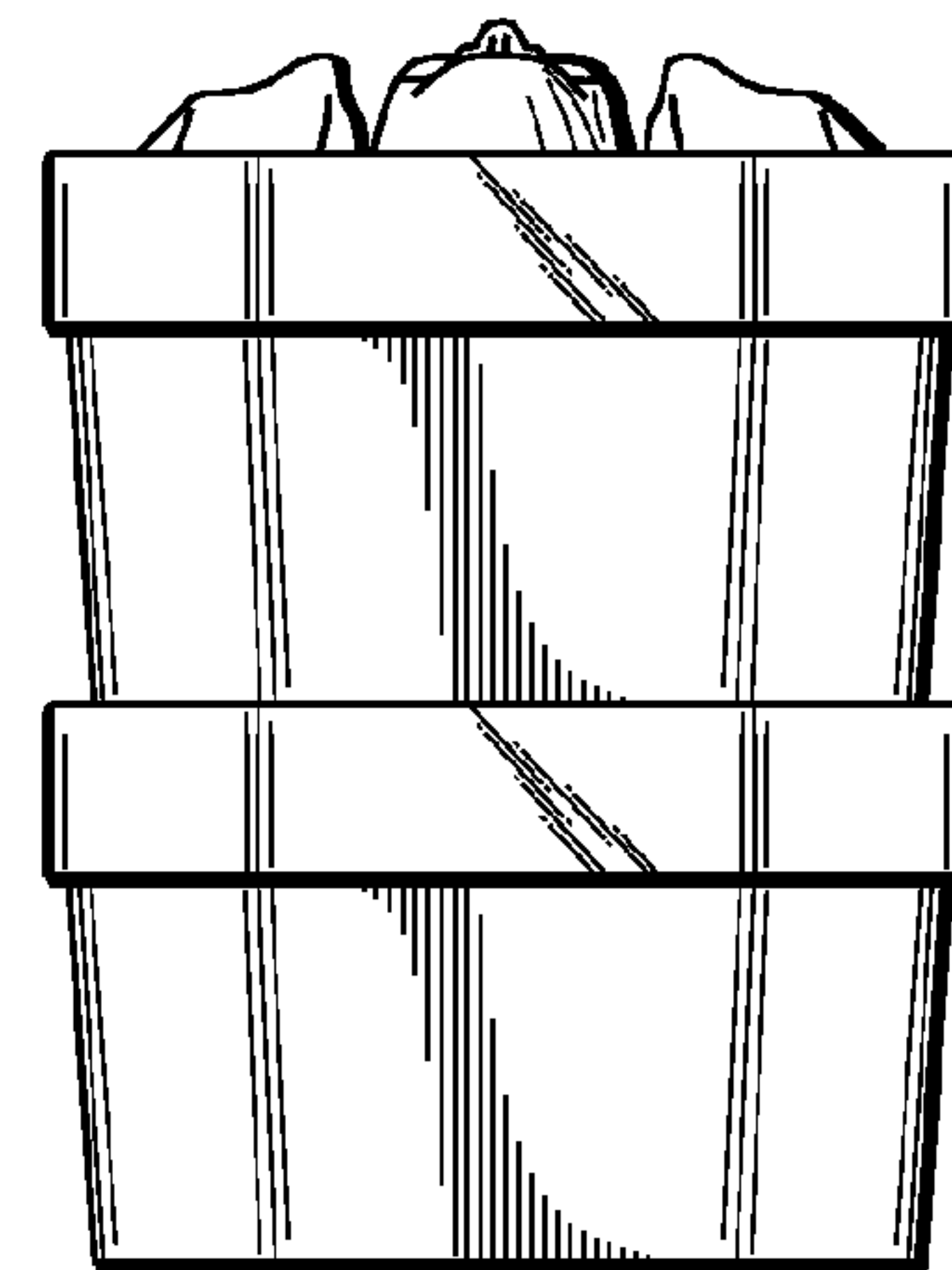

FIG. 11

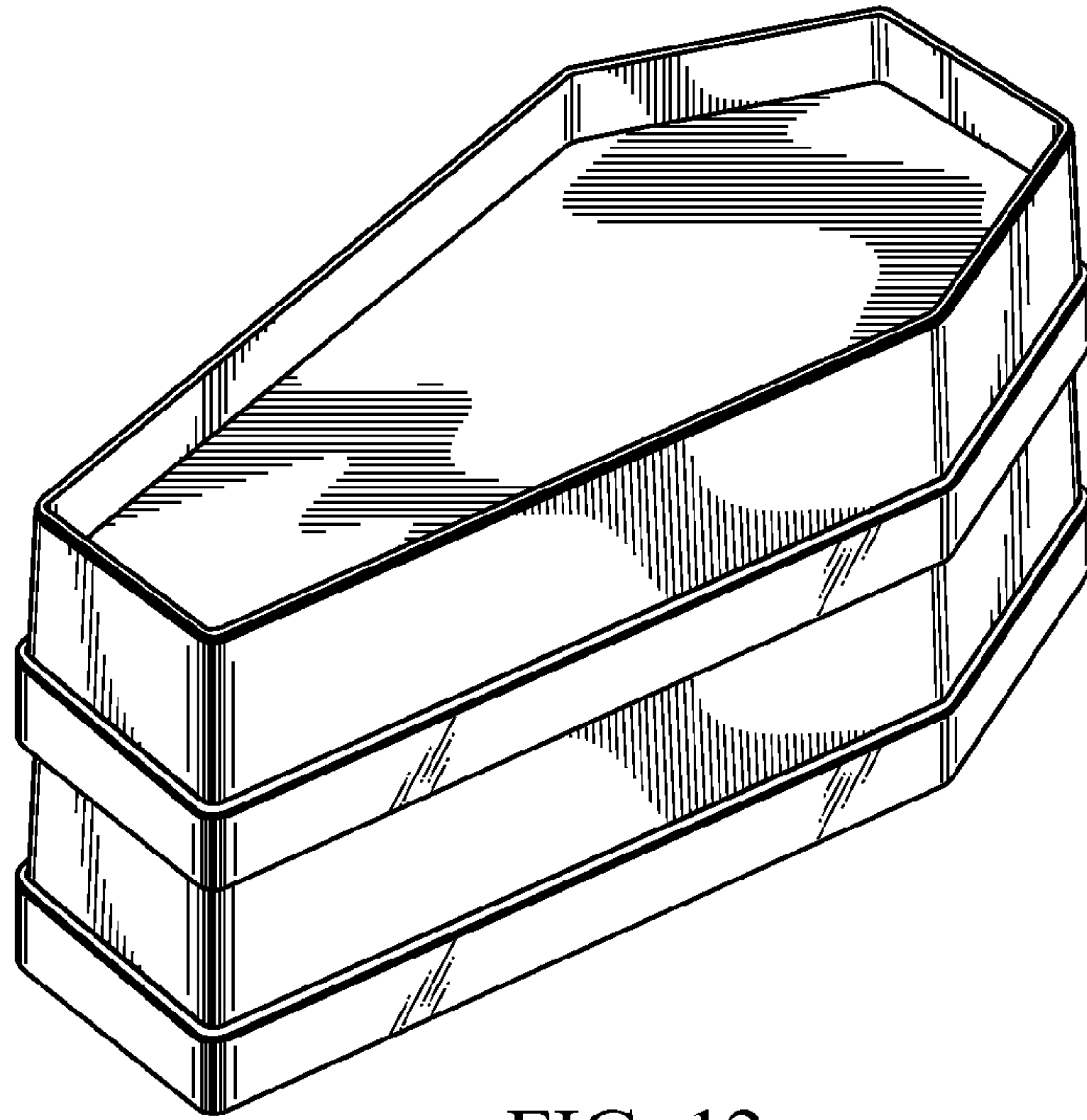

FIG. 12

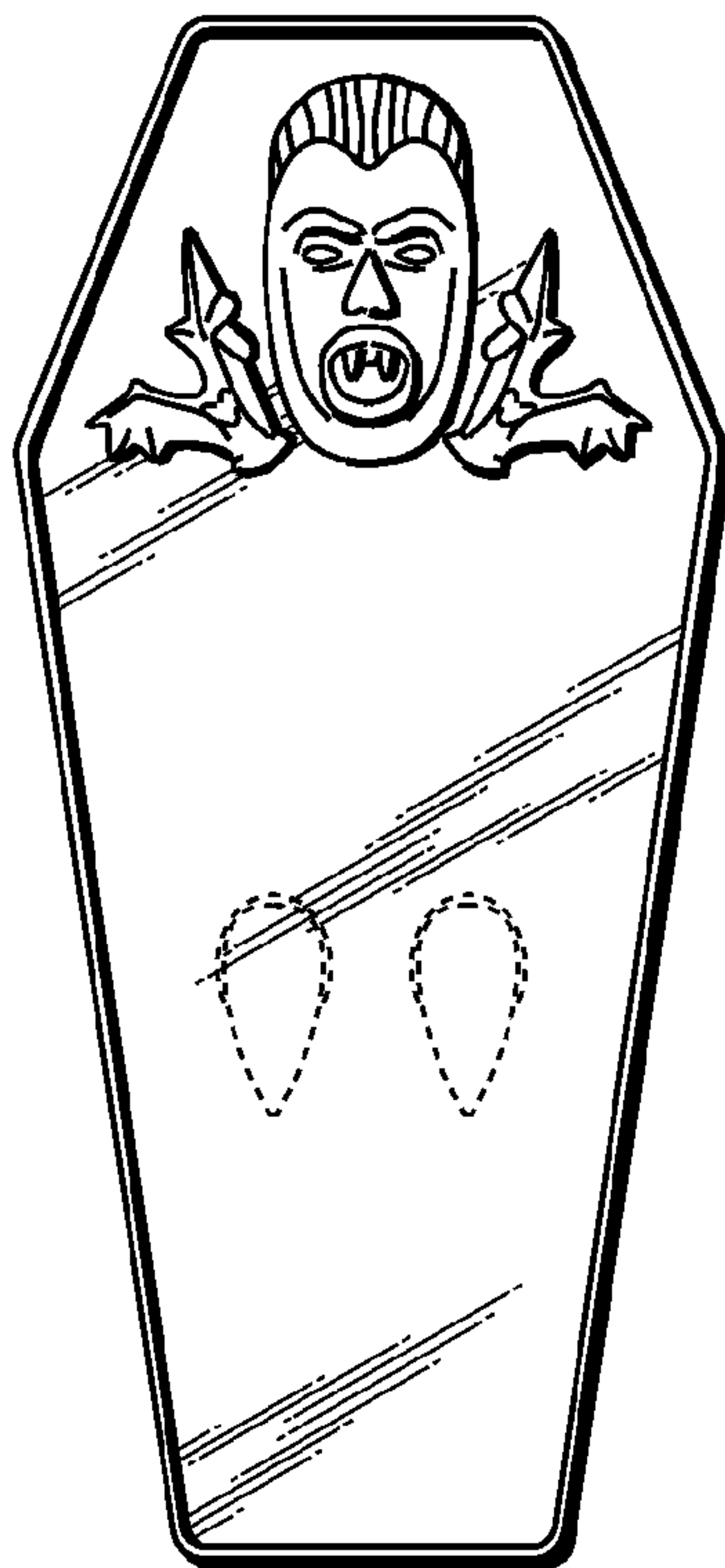

FIG. 13

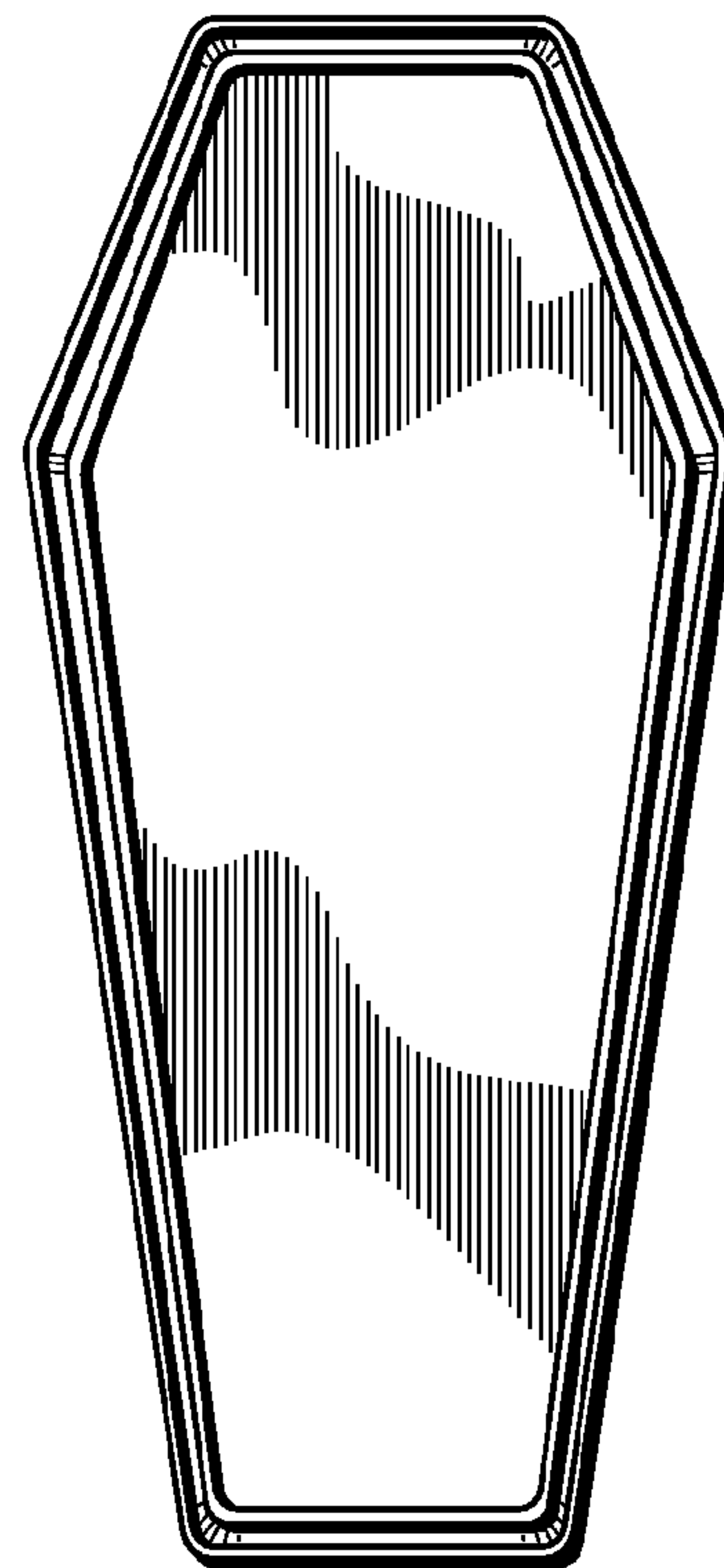

FIG. 14

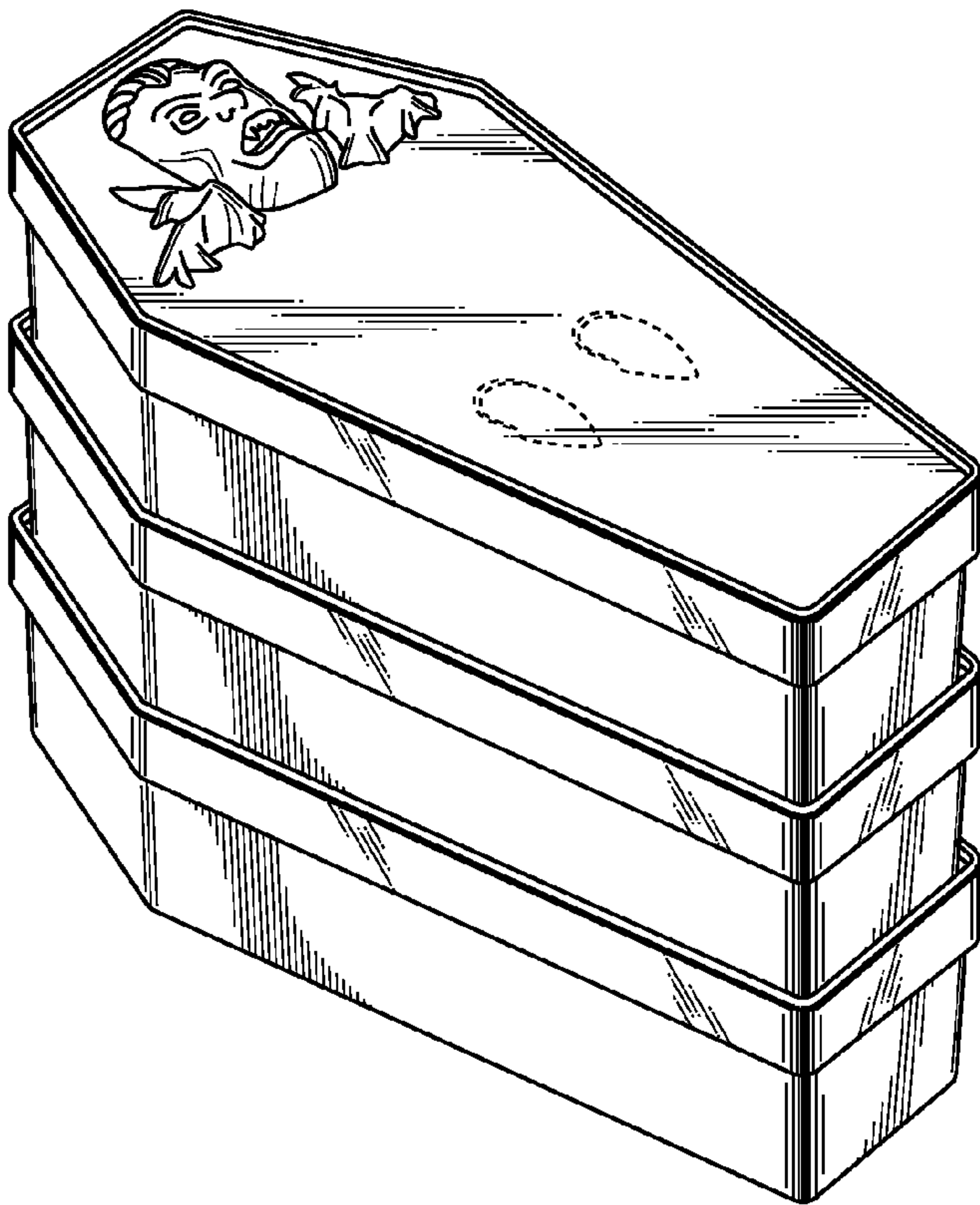

FIG. 15

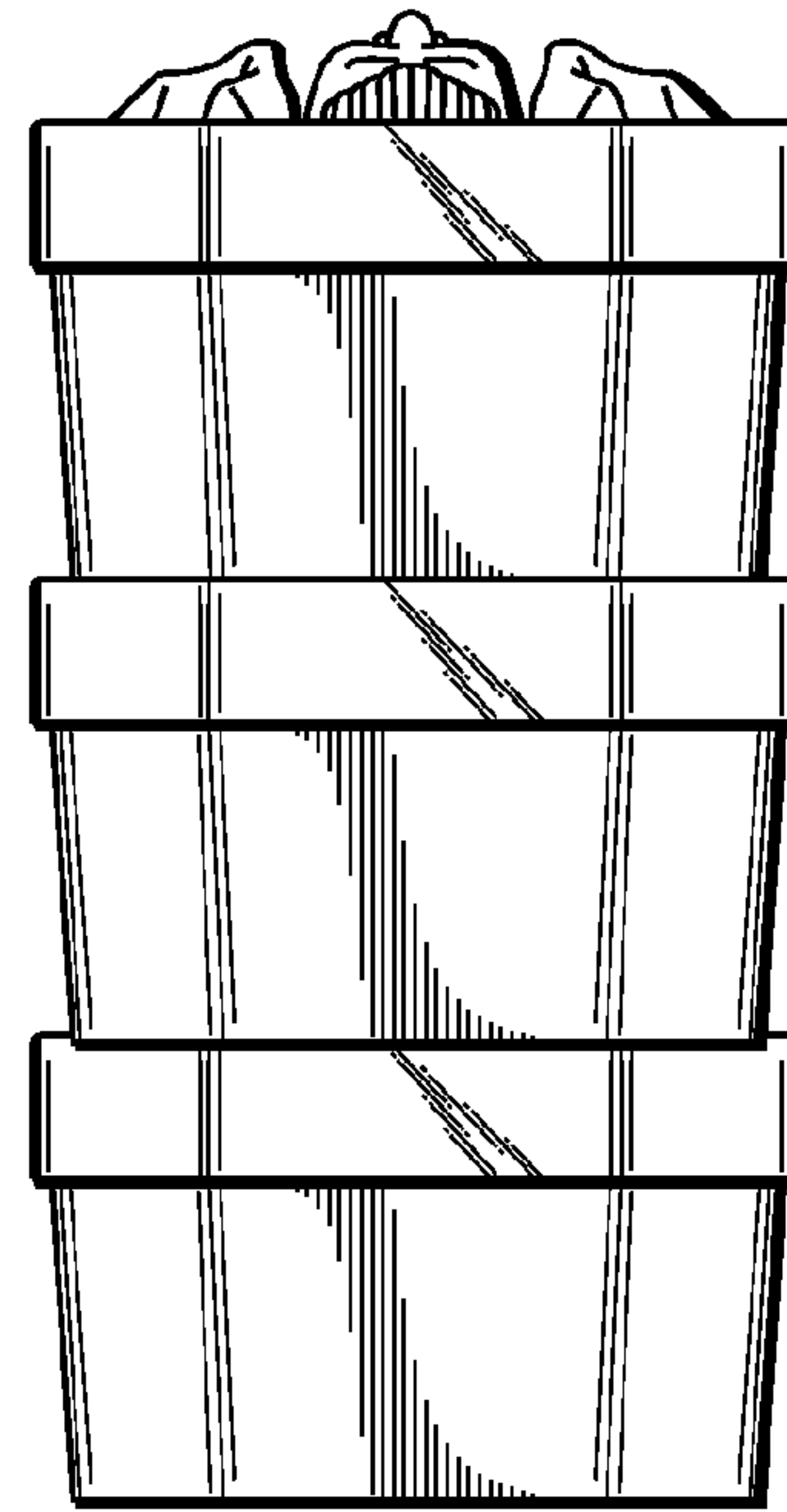

FIG. 17

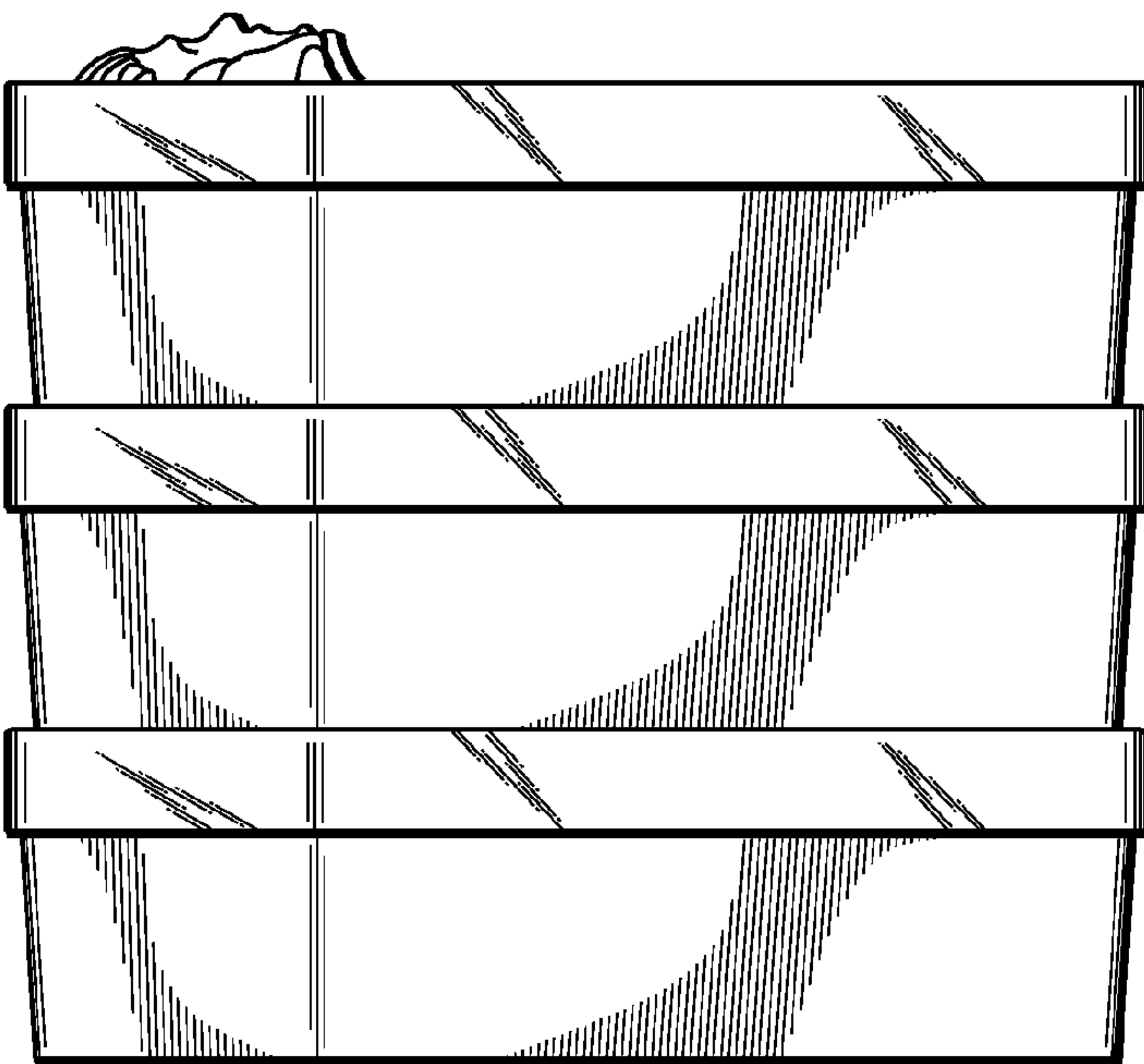

FIG. 16

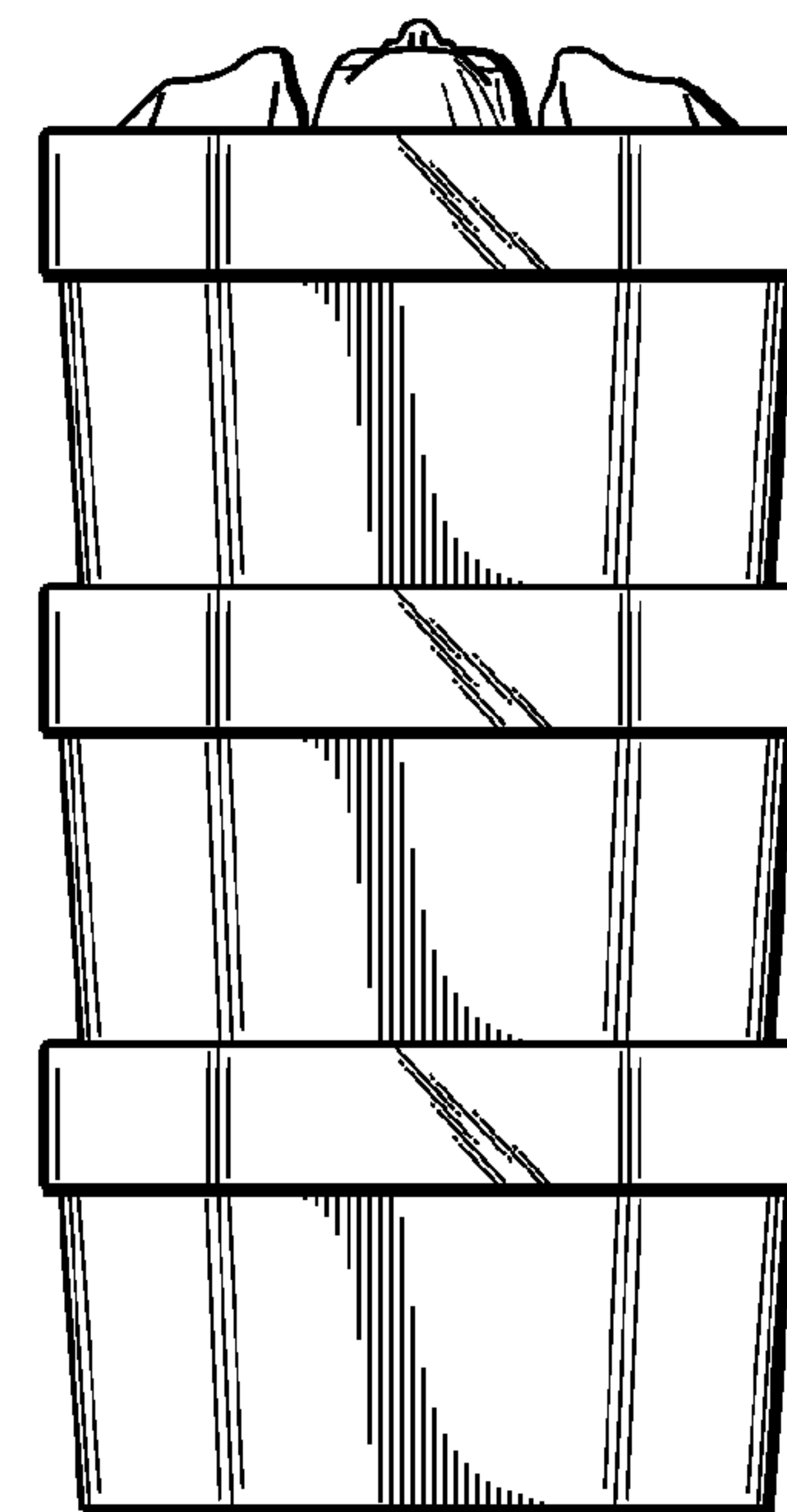

FIG. 18

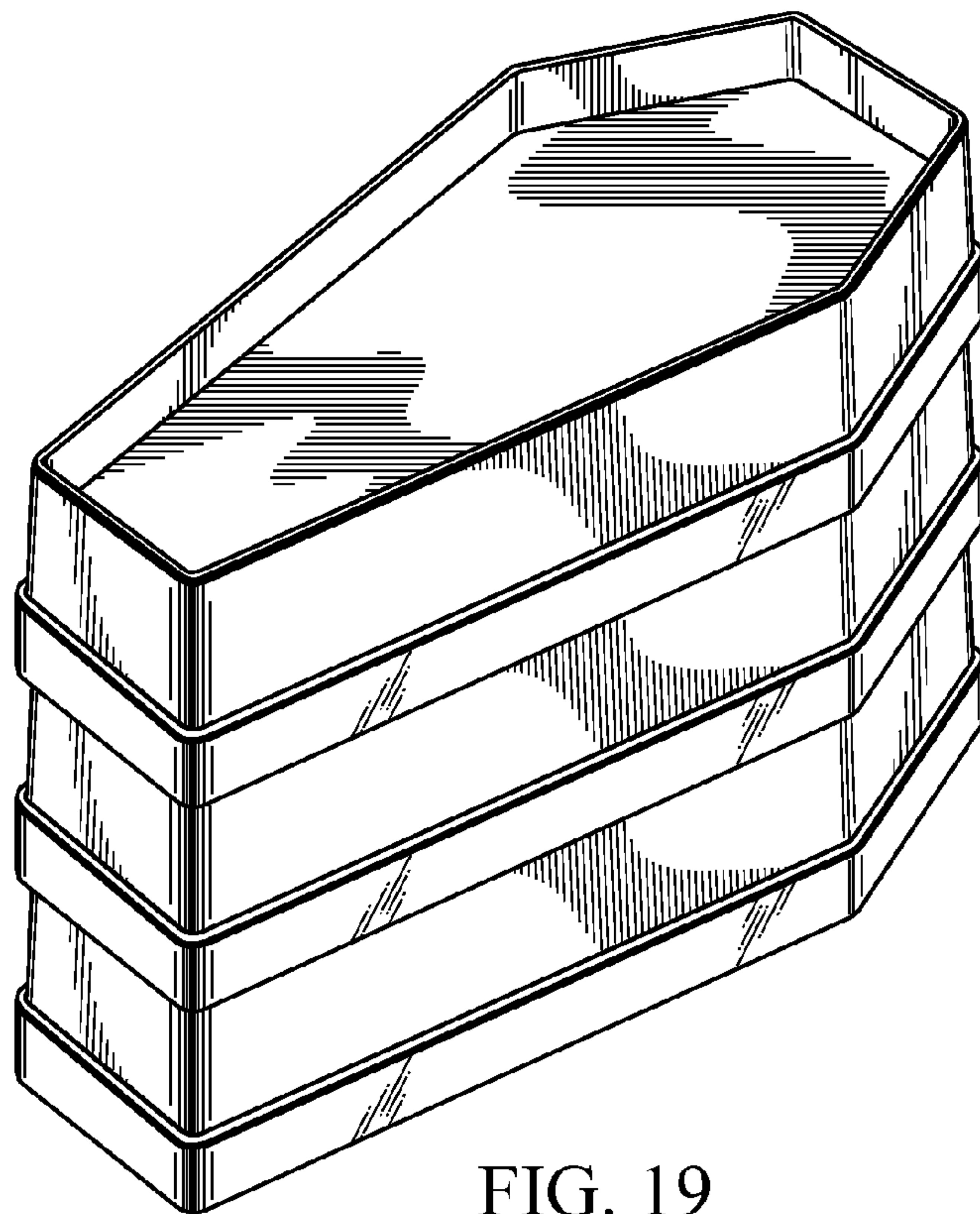

FIG. 19

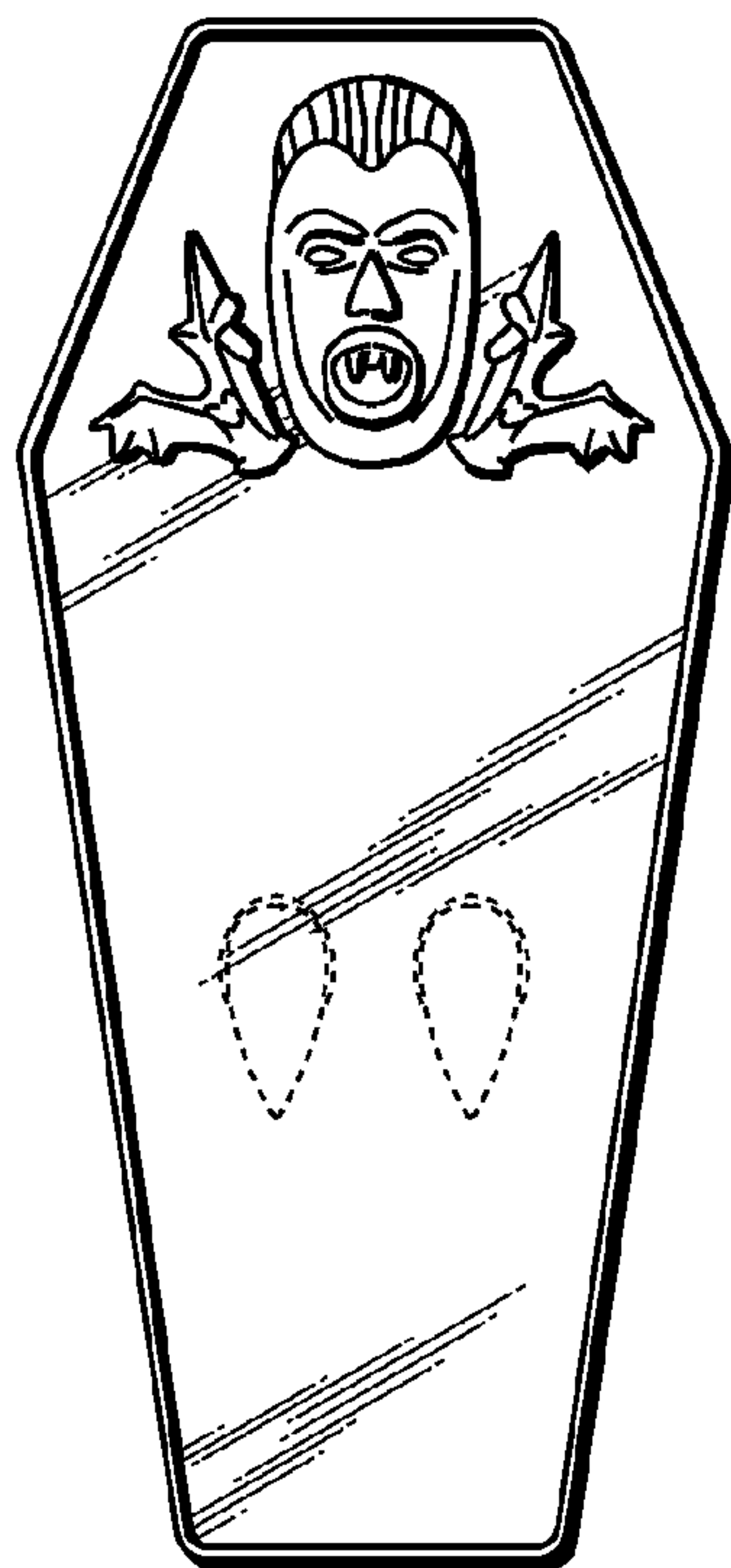

FIG. 20

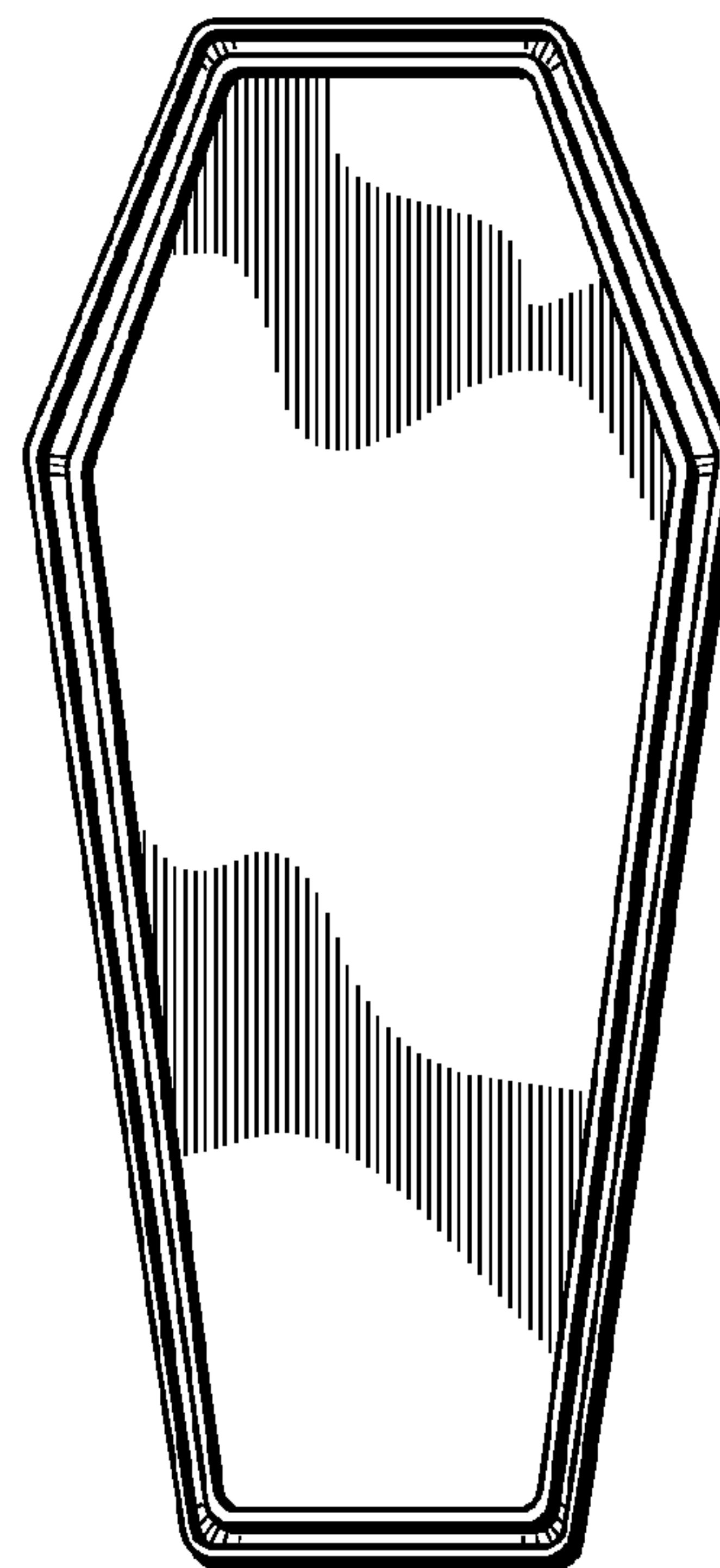

FIG. 21