



US00D551804S

(12) **United States Design Patent** (10) **Patent No.:** **US D551,804 S**
Allen et al. (45) **Date of Patent:** **** Sep. 25, 2007**

(54) **COMPACT**

(75) Inventors: **Harry S. Allen**, New York, NY (US);
Shawn Booth, Woodside, NY (US);
Thomas Yu, Staten Island, NY (US)

(73) Assignee: **Target Brands, Inc.**, Minneapolis, MN (US)

(**) Term: **14 Years**

(21) Appl. No.: **29/255,095**

(22) Filed: **Mar. 3, 2006**

(51) **LOC (8) Cl.** **28-03**

(52) **U.S. Cl.** **D28/78**

(58) **Field of Classification Search** D28/64.1,
D28/64.3, 76-84; 132/286-288, 293-307,
132/312-318; 206/581, 823

See application file for complete search history.

(56) **References Cited**

U.S. PATENT DOCUMENTS

D61,753 S	1/1923	Foster	
D63,502 S	12/1923	Slater	
1,546,302 A	7/1925	Mehigan	
D117,639 S	11/1939	Rich	
D145,100 S	6/1946	Muller-Munk	
D176,876 S	2/1956	Sutton	
2,734,517 A	2/1956	Ferraro	
D252,590 S *	8/1979	Peretti et al.	D28/80
D280,137 S	8/1985	Guttenplan et al.	
D280,245 S	8/1985	Buchet	
D280,354 S	8/1985	Bakic	
D286,331 S	10/1986	Scoccola	
D299,561 S	1/1989	Bakic	
4,826,014 A	5/1989	Schefer	
D302,872 S	8/1989	Bakic	
D303,581 S *	9/1989	Bakic	D28/78
D303,582 S	9/1989	Gavin	
D303,724 S	9/1989	Hornig et al.	
5,031,764 A	7/1991	Meador et al.	
D343,925 S *	2/1994	Garouste et al.	D28/78
D370,306 S	5/1996	Stevens	

5,626,155 A	5/1997	Saute	
5,735,297 A	4/1998	Litton	
D394,131 S	5/1998	Litton	
D445,563 S	7/2001	Cautereels	
D462,484 S	9/2002	Lai	
D497,037 S	10/2004	Rodriguez	
D517,733 S *	3/2006	Tsai	D28/78
2002/0036155 A1	3/2002	Freeman et al.	
2003/0010351 A1	1/2003	de Laforcade	

* cited by examiner

Primary Examiner—Jennifer Rivard

(74) Attorney, Agent, or Firm—Ingrassia Fisher & Lorenz, P.C.

(57) **CLAIM**

The ornamental design for a compact, as shown and described.

DESCRIPTION

FIG. 1 is a perspective view of a compact showing one embodiment of my new design in a closed position;

FIG. 2 is a top view thereof in the closed position;

FIG. 3 is a bottom view thereof in the closed position,

FIG. 4 is a rear view thereof in the closed position;

FIG. 5 is a front view thereof in the closed position;

FIG. 6 is a right side view thereof in the closed position;

FIG. 7 is a left side view thereof in the closed position;

FIG. 8 is a perspective view thereof in an open position;

FIG. 9 is a top view thereof in an open position;

FIG. 10 is a bottom view thereof in an open position;

FIG. 11 is a rear view thereof in an open position;

FIG. 12 is a front view thereof in an open position;

FIG. 13 is a right side view thereof in an open position; and,

FIG. 14 is a left side view thereof in an open position.

The broken lines are shown for illustrative purposes only and form no part of the claimed design.

1 Claim, 4 Drawing Sheets

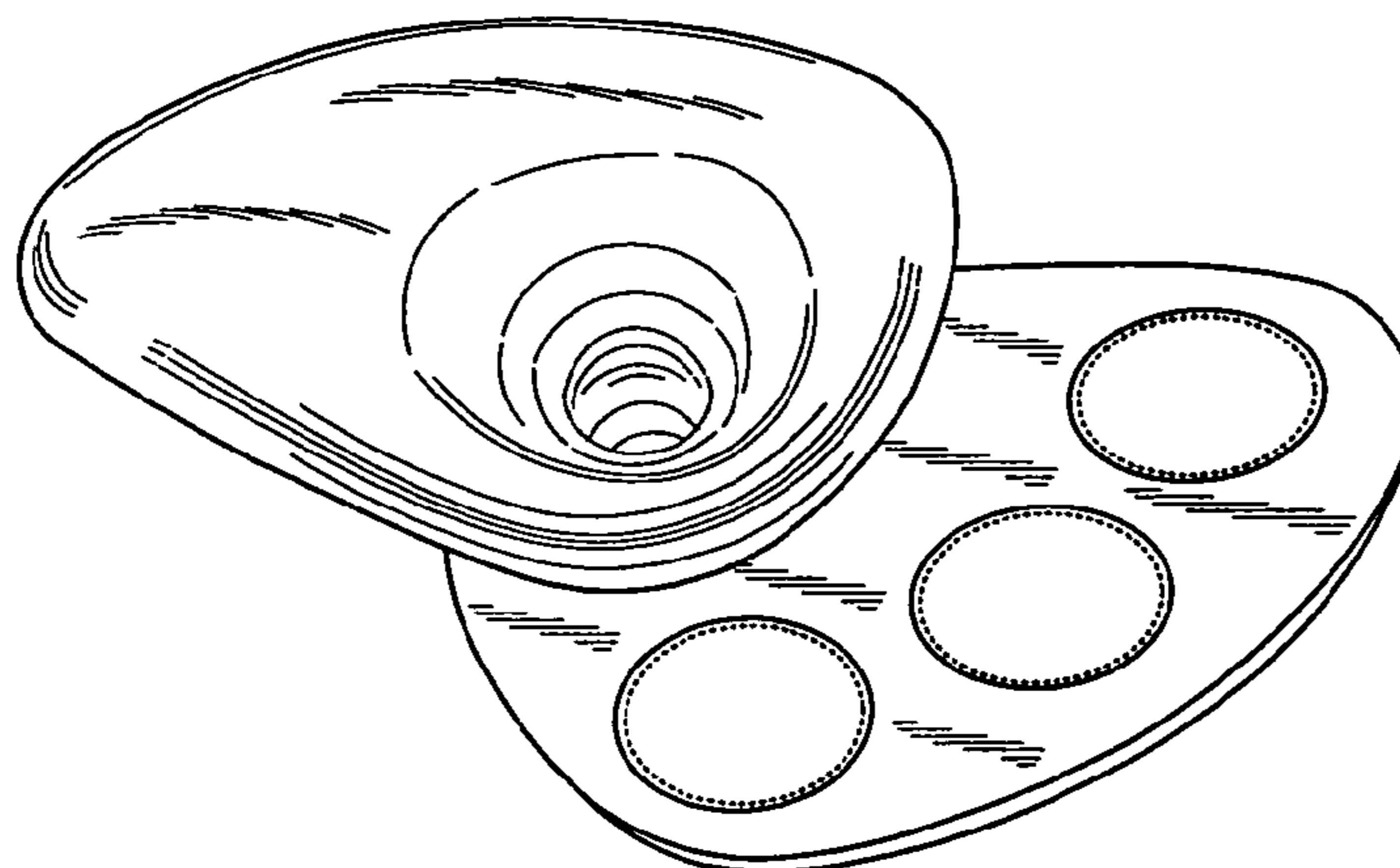

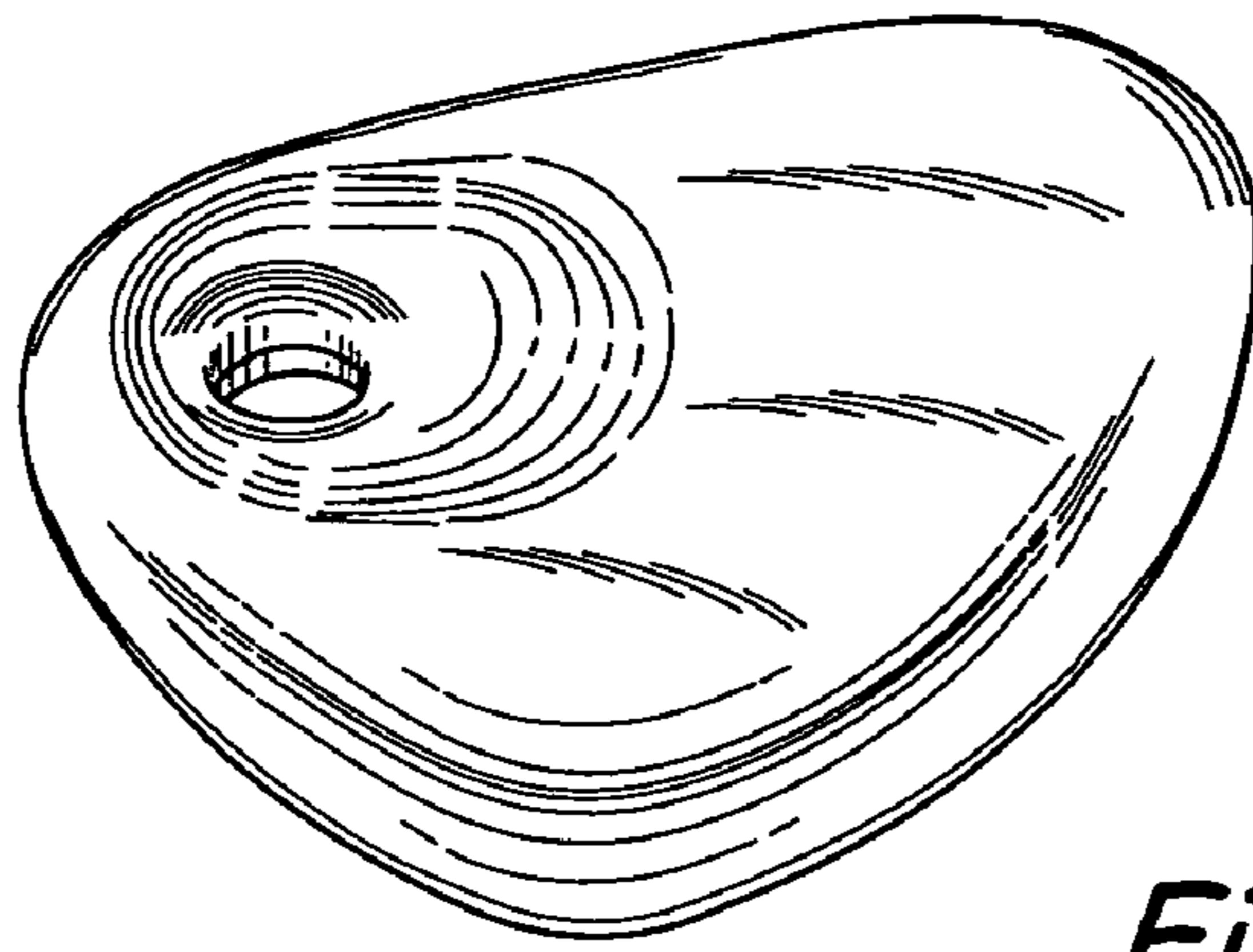

Fig. 1

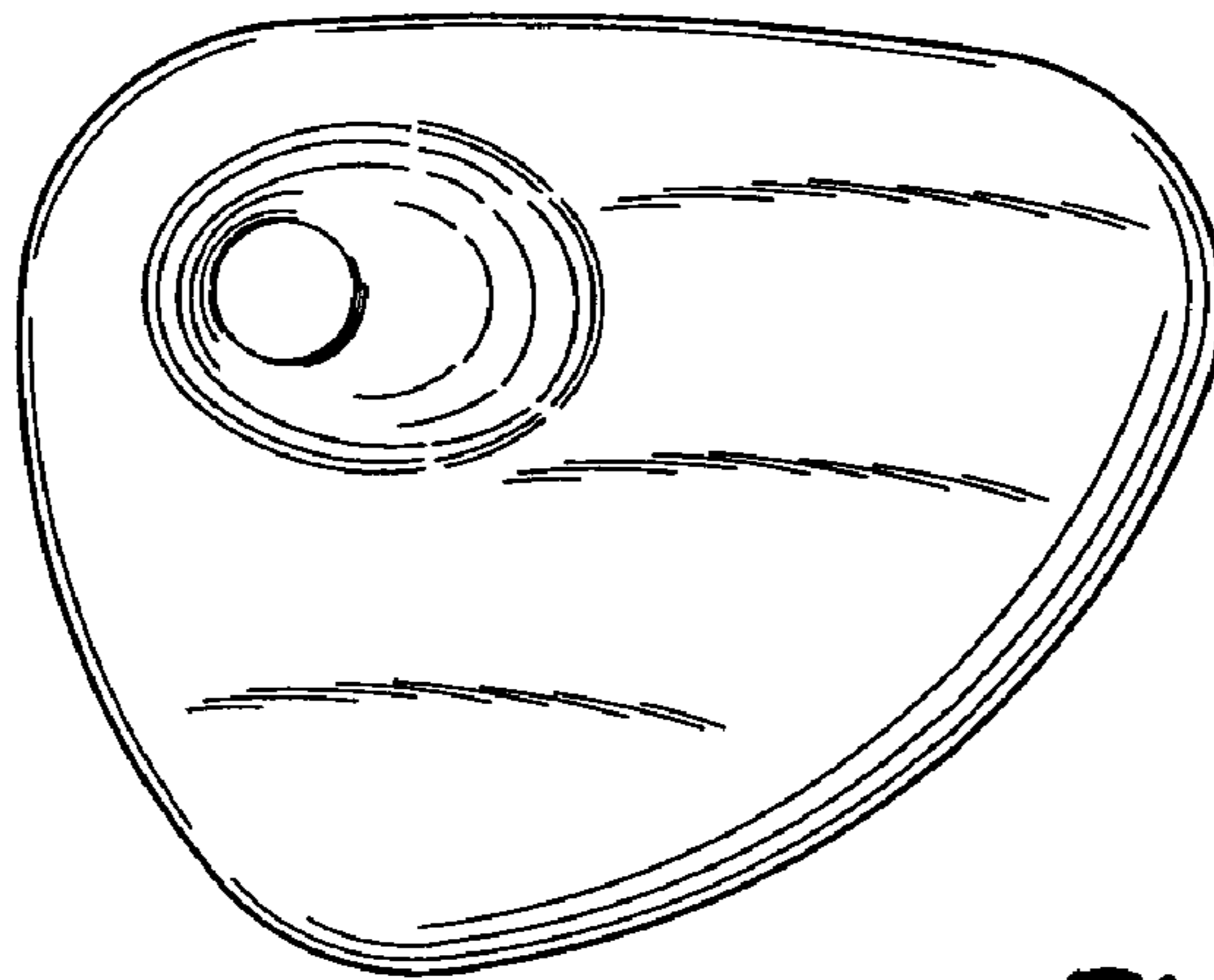

Fig. 2

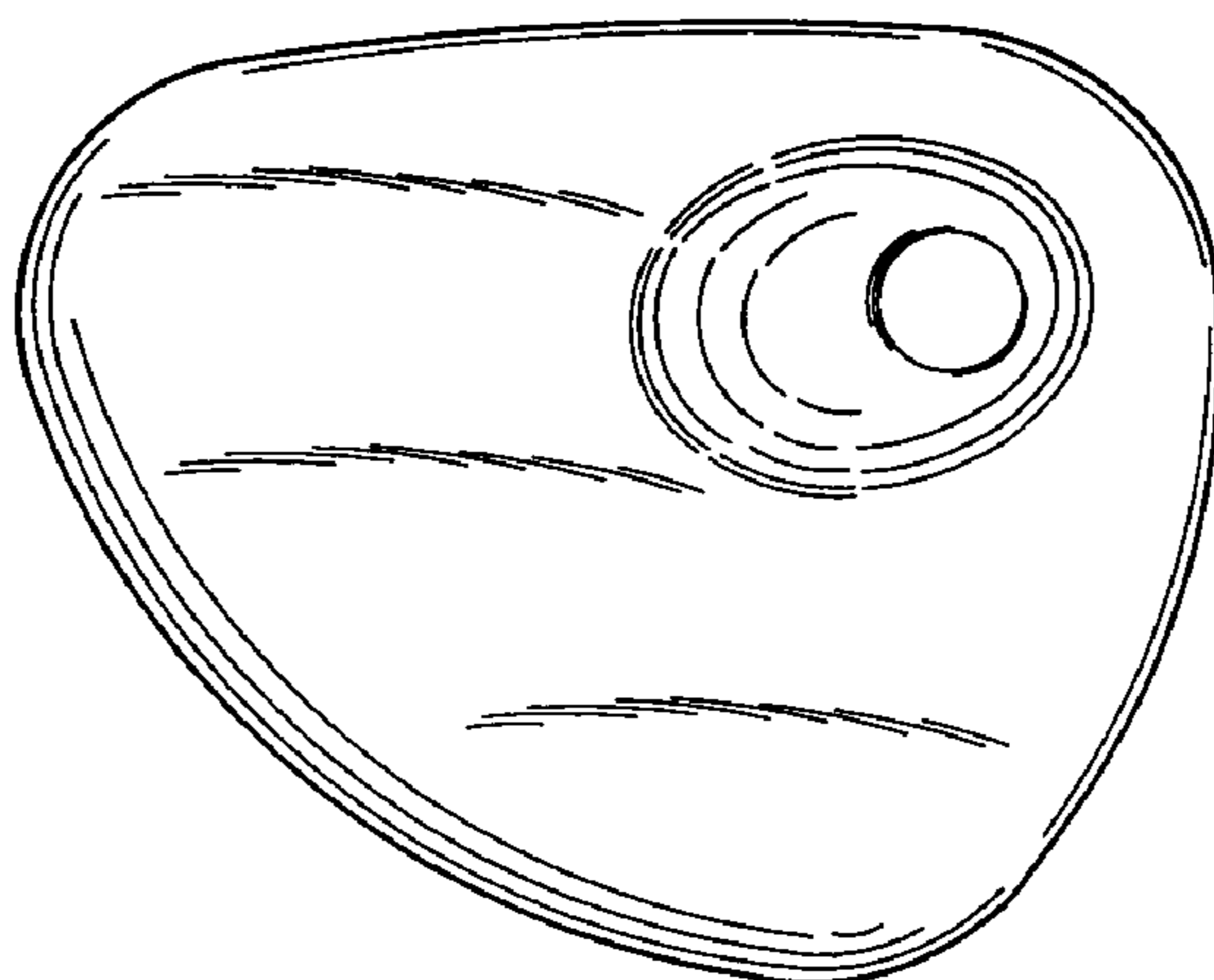

Fig. 3

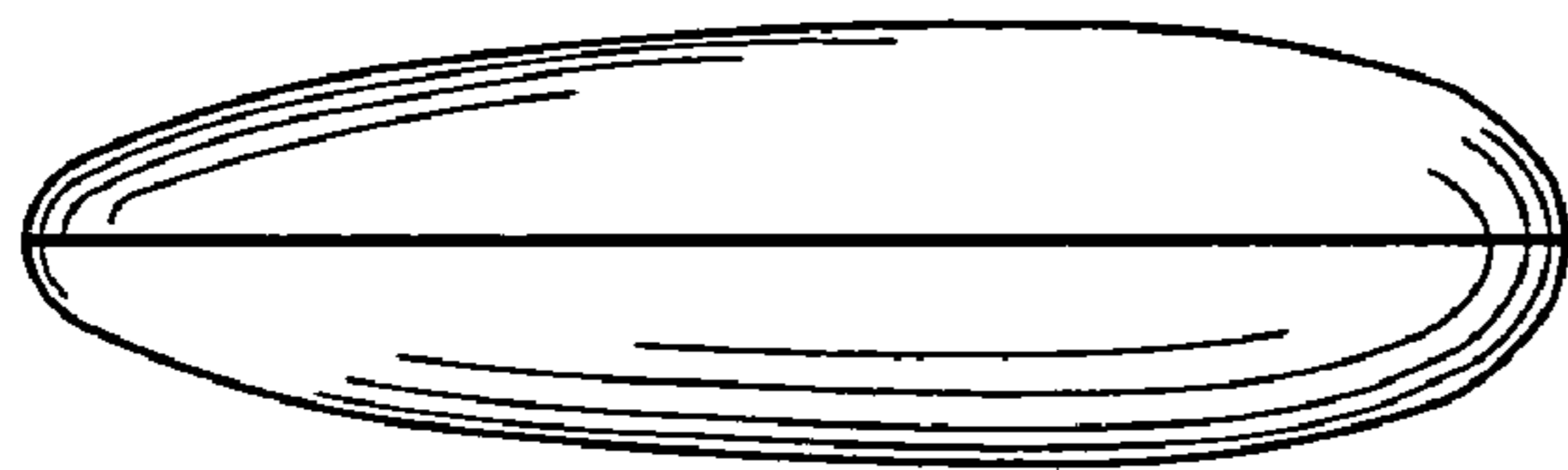

Fig. 4

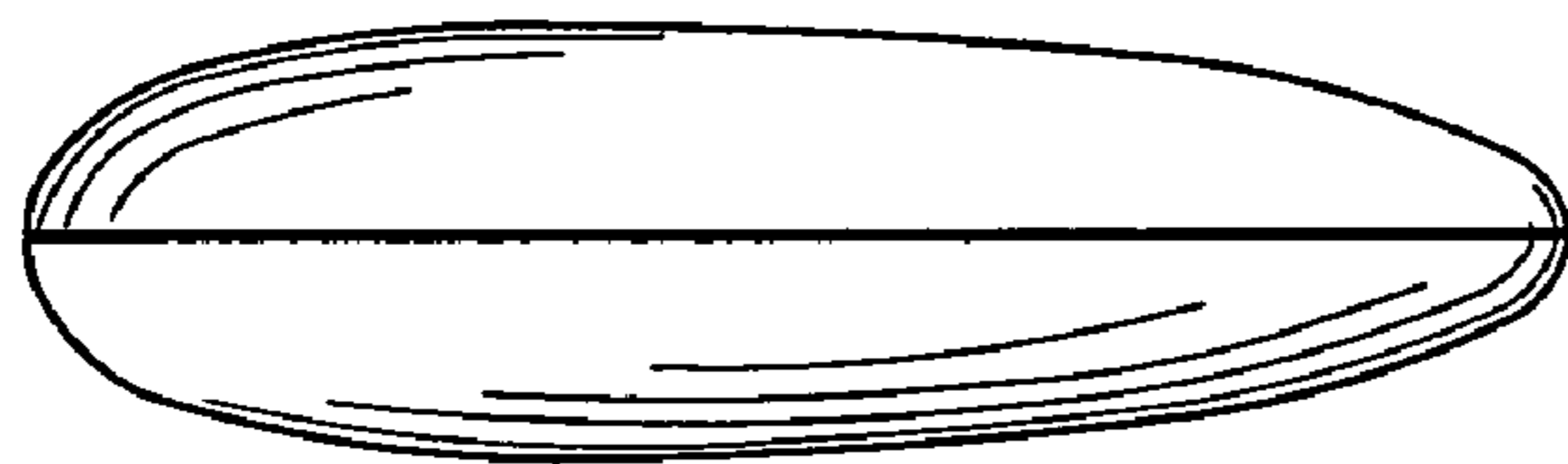

Fig. 5

Fig. 6

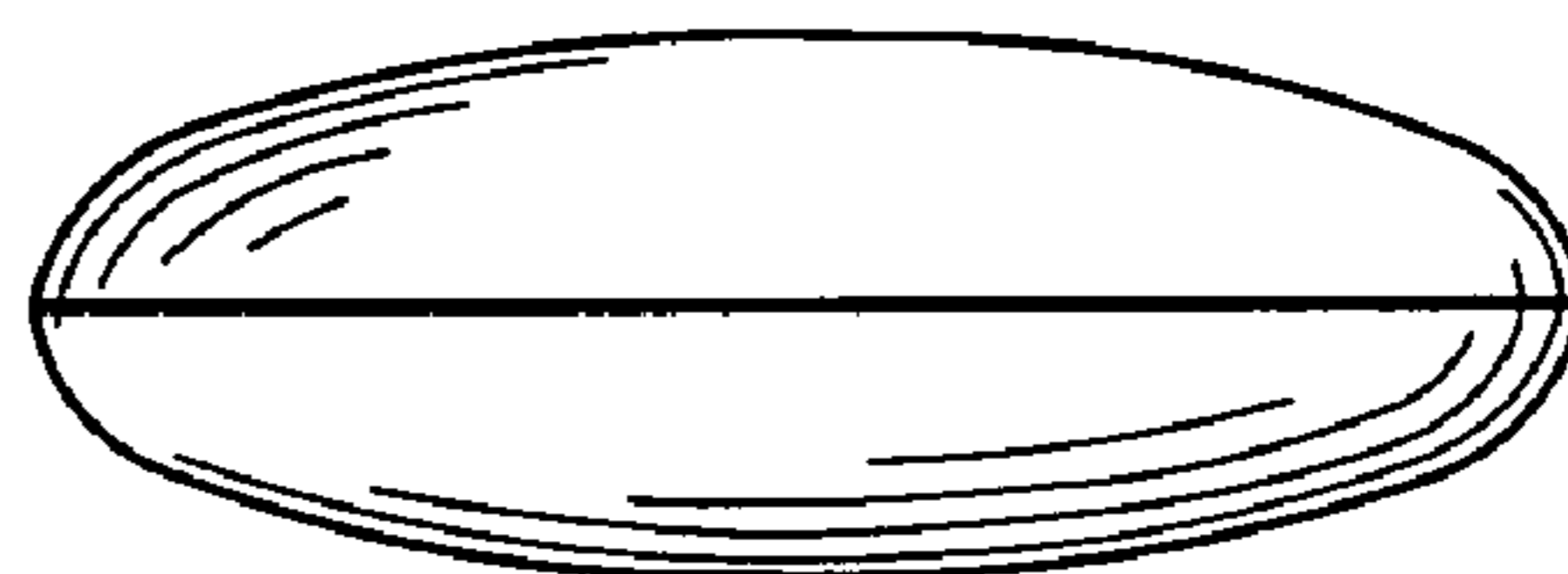
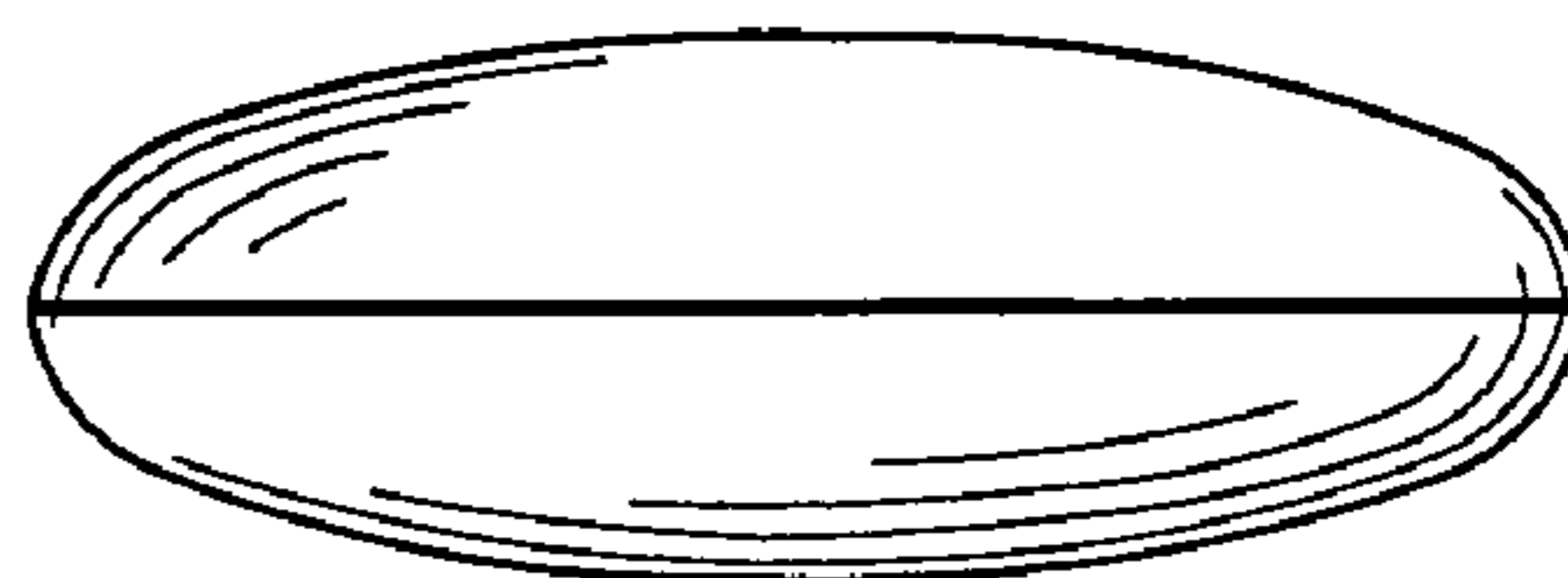

Fig. 7



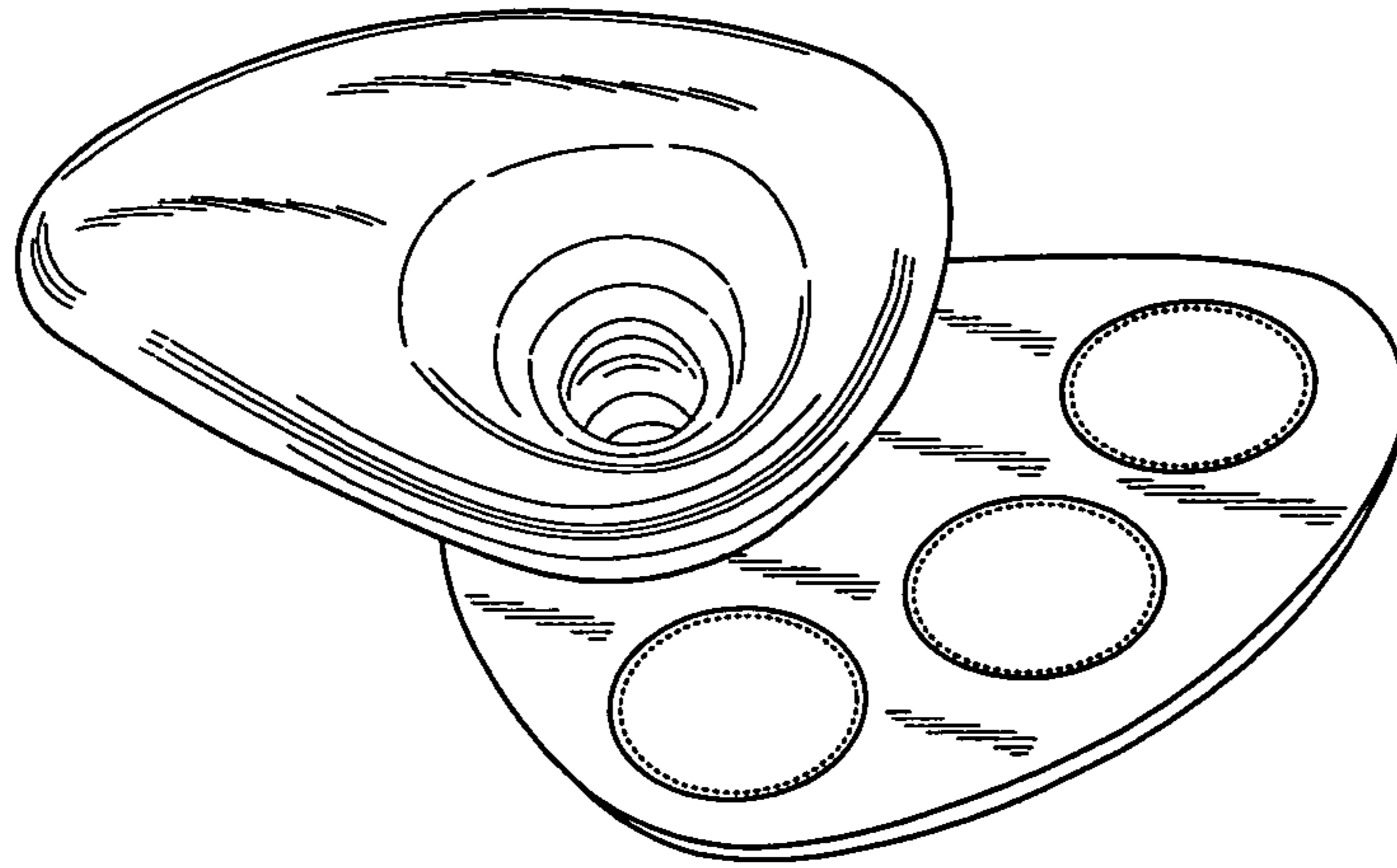

Fig. 8

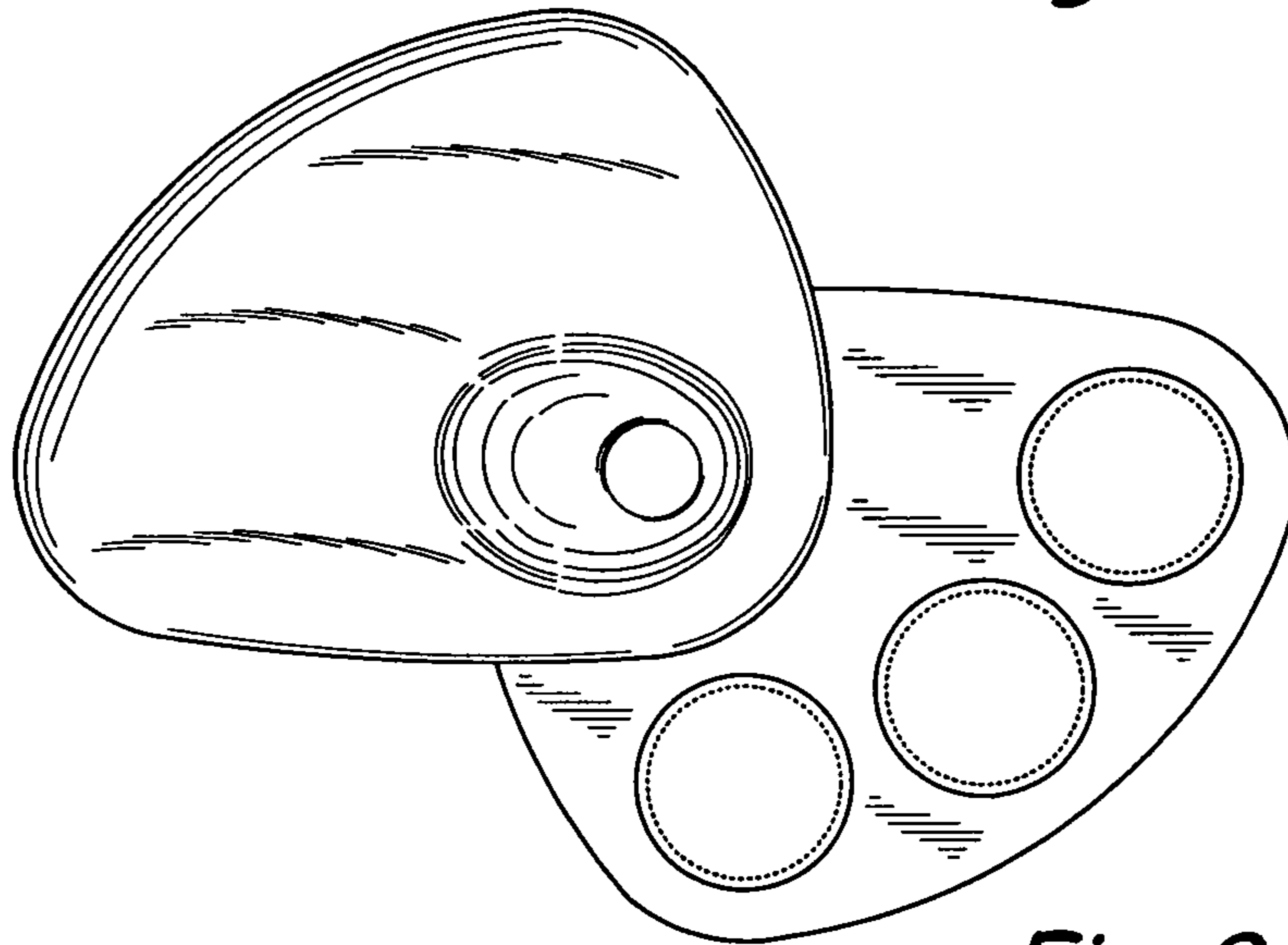

Fig. 9

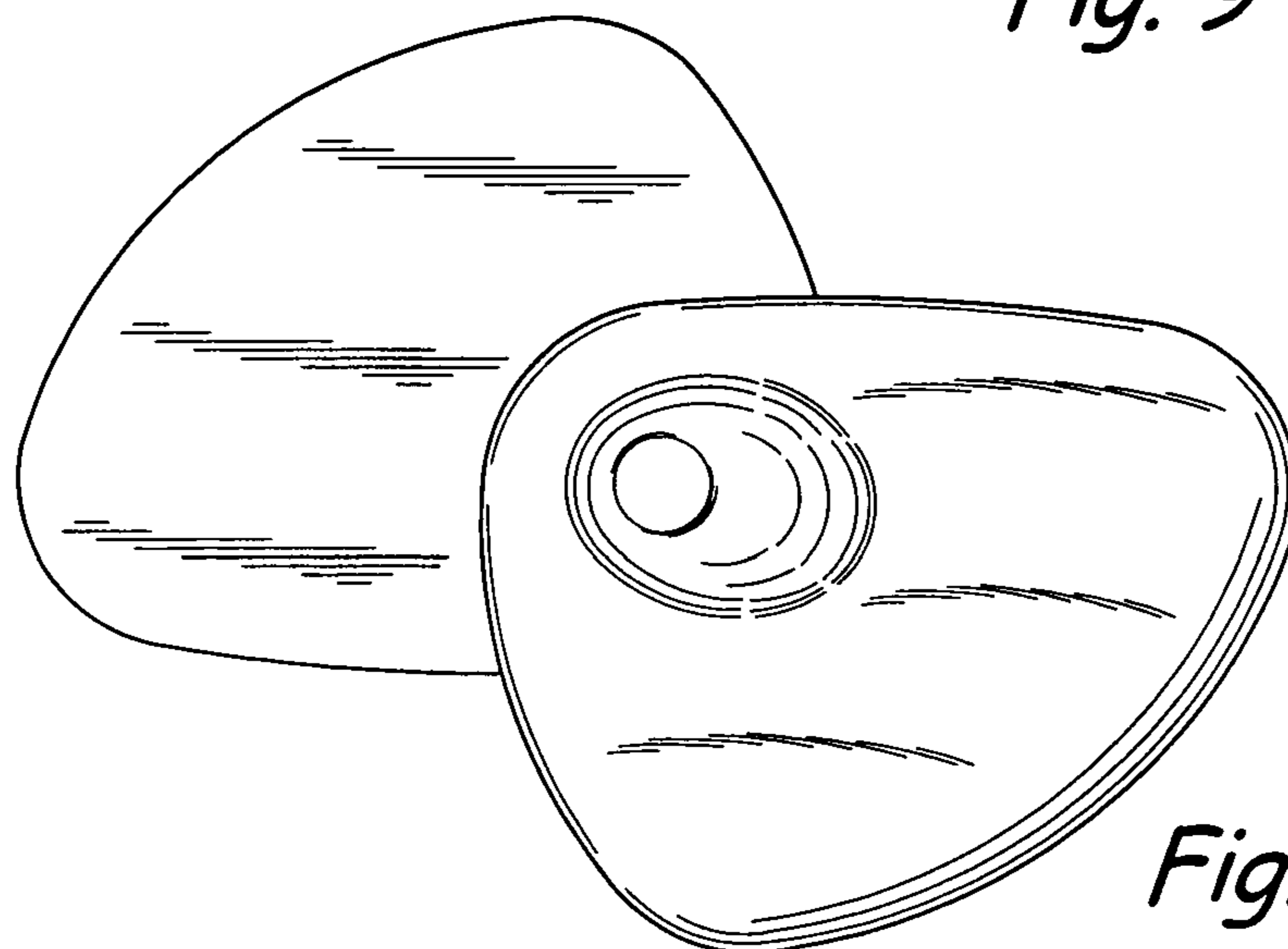

Fig. 10

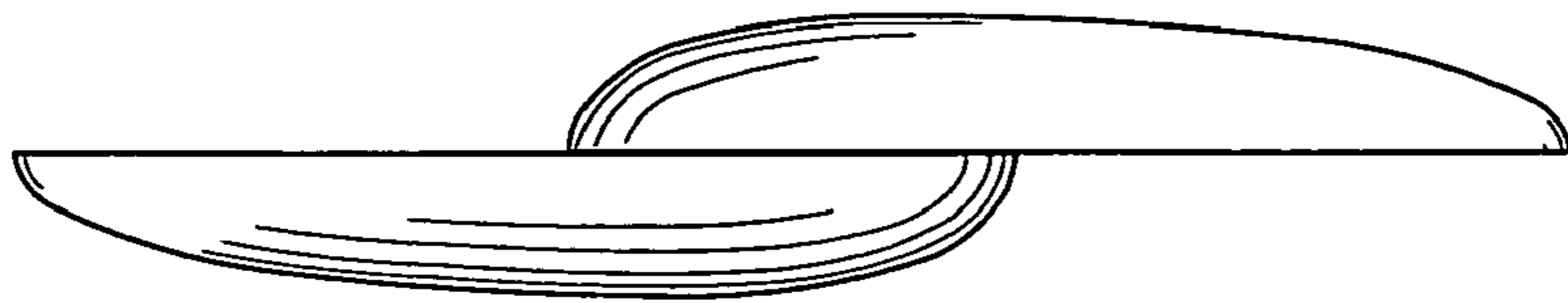

Fig. 11

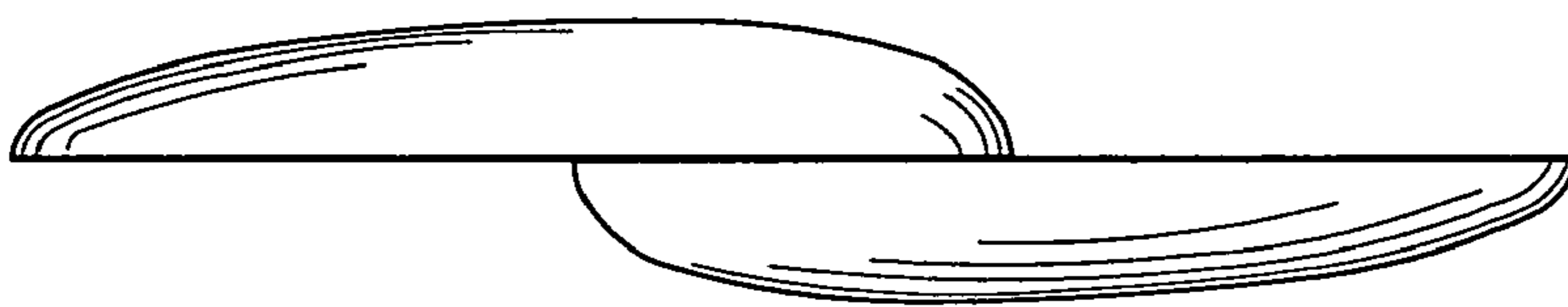

Fig. 12

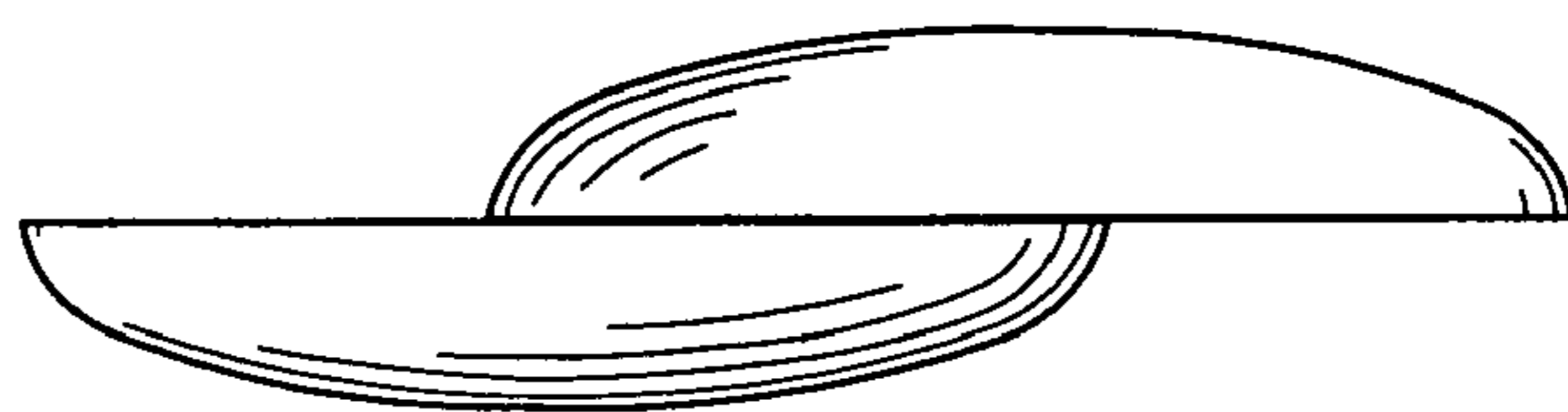

Fig. 13

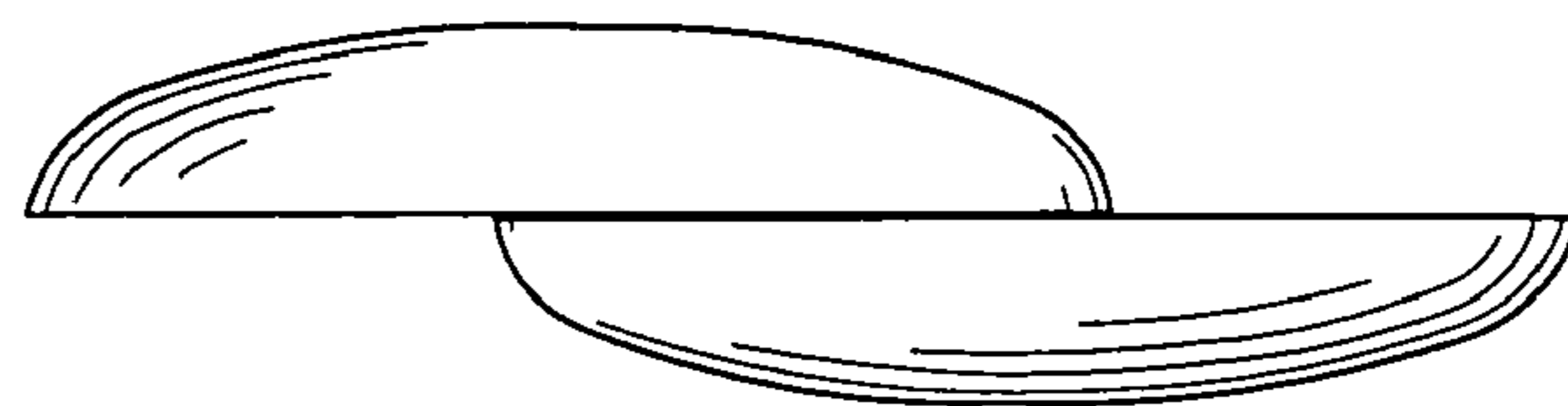

Fig. 14