



US00D551742S

(12) **United States Design Patent** (10) **Patent No.:** **US D551,742 S**
Plikuhn (45) **Date of Patent:** **** Sep. 25, 2007**

(54) **SINK**

(75) Inventor: **Deborah Marie Plikuhn**, Lombard, IL (US)

(73) Assignee: **Elkay Manufacturing Company**, Oak Brook, IL (US)

(**) Term: **14 Years**

(21) Appl. No.: **29/258,255**

(22) Filed: **Apr. 19, 2006**

(51) **LOC (8) Cl.** **23-02**

(52) **U.S. Cl.** **D23/284**

(58) **Field of Classification Search** D23/270–273, D23/284–287, 289, 291–293.1, 303, 308; 4/619, 630–631, 637, 661; D21/524
See application file for complete search history.

(56) **References Cited**

U.S. PATENT DOCUMENTS

D78,257 S	4/1929	Bonner, Jr.	
D183,047 S	6/1958	Helmer	
3,108,288 A	10/1963	Herzog	
D198,305 S	6/1964	Graning, Jr.	
D264,619 S	5/1982	Castleberry	
4,462,126 A	7/1984	Cleaveland	
4,587,680 A	5/1986	Brügger	
D307,465 S	4/1990	Phillips	
D316,295 S *	4/1991	Colani	D23/287
D337,377 S	7/1993	Bonnell et al.	
5,412,818 A *	5/1995	Chen	4/642
D425,187 S	5/2000	Adamavich	
D455,821 S	4/2002	Bayer et al.	
D464,126 S	10/2002	Bayer et al.	
D506,245 S *	6/2005	Painter	D23/287

OTHER PUBLICATIONS

U.S. Appl. No. 29/258,240, Plikuhn, filed Apr. 19, 2006.
U.S. Appl. No. 29/258,259, Plikuhn, filed Apr. 19, 2006.
U.S. Appl. No. 29/258,261, Plikuhn, filed Apr. 19, 2006.
KOHLER, "The Bold Look of Kohler: All Sinks," retrieved from http://www.us.kohler.com/onlinecatalog/product_result.

jsp?showAll=true§ion=1&category=5&subcategory=36&frm=null&module=Kitchen+Sinks&cat_count=7&QS_0=All&QS_1=All&QS_2=All&QS_3=All&QS_4=All&QS_5=All&QS_6=All&sort=Default on Aug. 6, 2005.

* cited by examiner

Primary Examiner—Robert A. Delehanty
(74) *Attorney, Agent, or Firm*—Leydig, Voit & Mayer, Ltd.

(57) **CLAIM**

The ornamental design for a sink, as shown and described.

DESCRIPTION

FIG. 1 is a perspective view taken from the top, front, and right side of a sink showing my new design;

FIG. 2 is a perspective view taken from the top, front, and left side thereof;

FIG. 3 is a top plan view thereof;

FIG. 4 is a bottom view thereof

FIG. 5 is a front side view thereof;

FIG. 6 is a rear side view thereof;

FIG. 7 is a left side view thereof;

FIG. 8 is a right side view thereof;

FIG. 9 is a perspective view taken from the top, front, and left side of a second embodiment of a sink showing my new design;

FIG. 10 is a perspective view taken from the top, front, and right side thereof;

FIG. 11 is a top plan view thereof;

FIG. 12 is a bottom view thereof;

FIG. 13 is a front side view thereof;

FIG. 14 is a rear side view thereof;

FIG. 15 is a left side view thereof; and,

FIG. 16 is a right side view thereof.

The broken lines disclosing a sink flange and an opening for preventing overflow are for illustration purposes only and form no part of the claimed design.

1 Claim, 12 Drawing Sheets

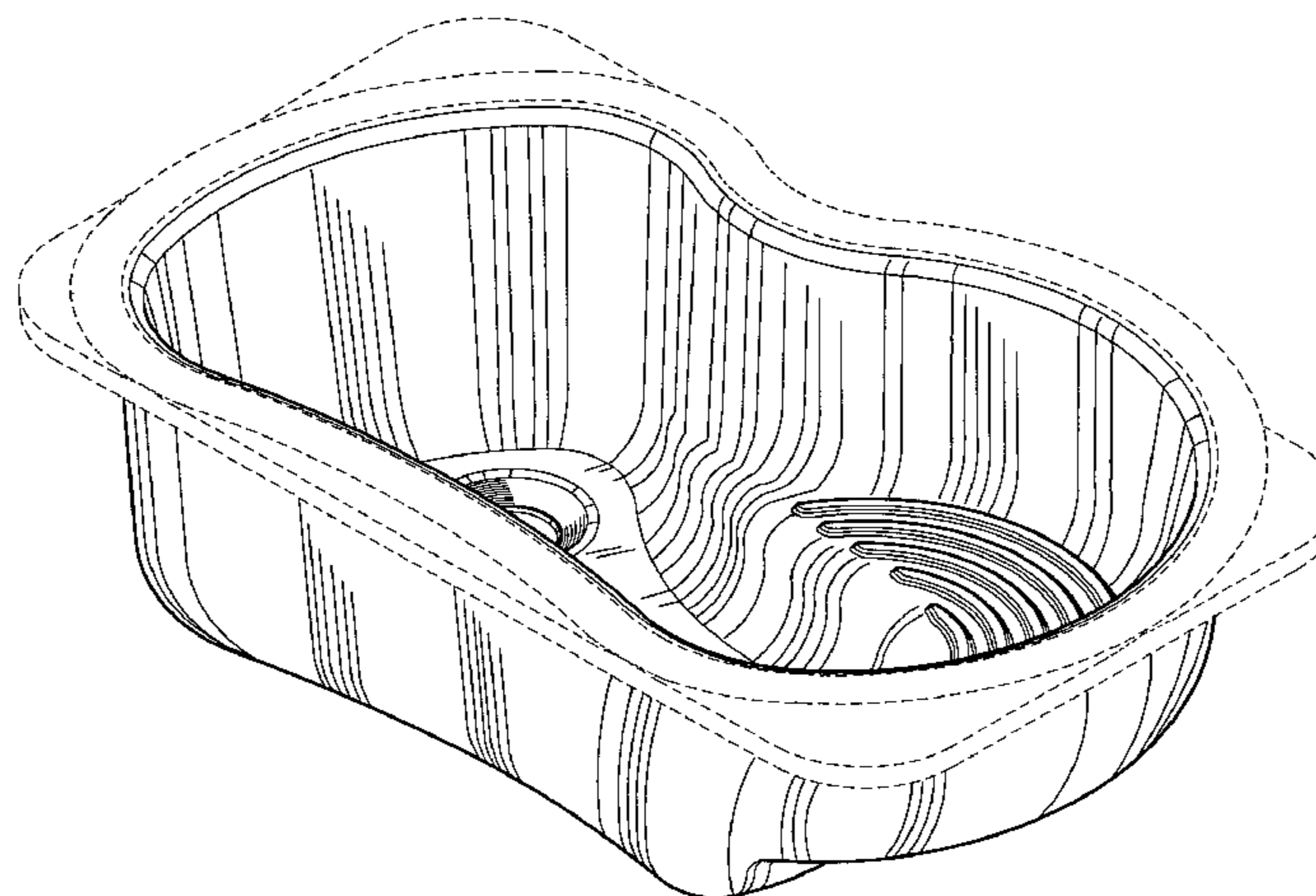
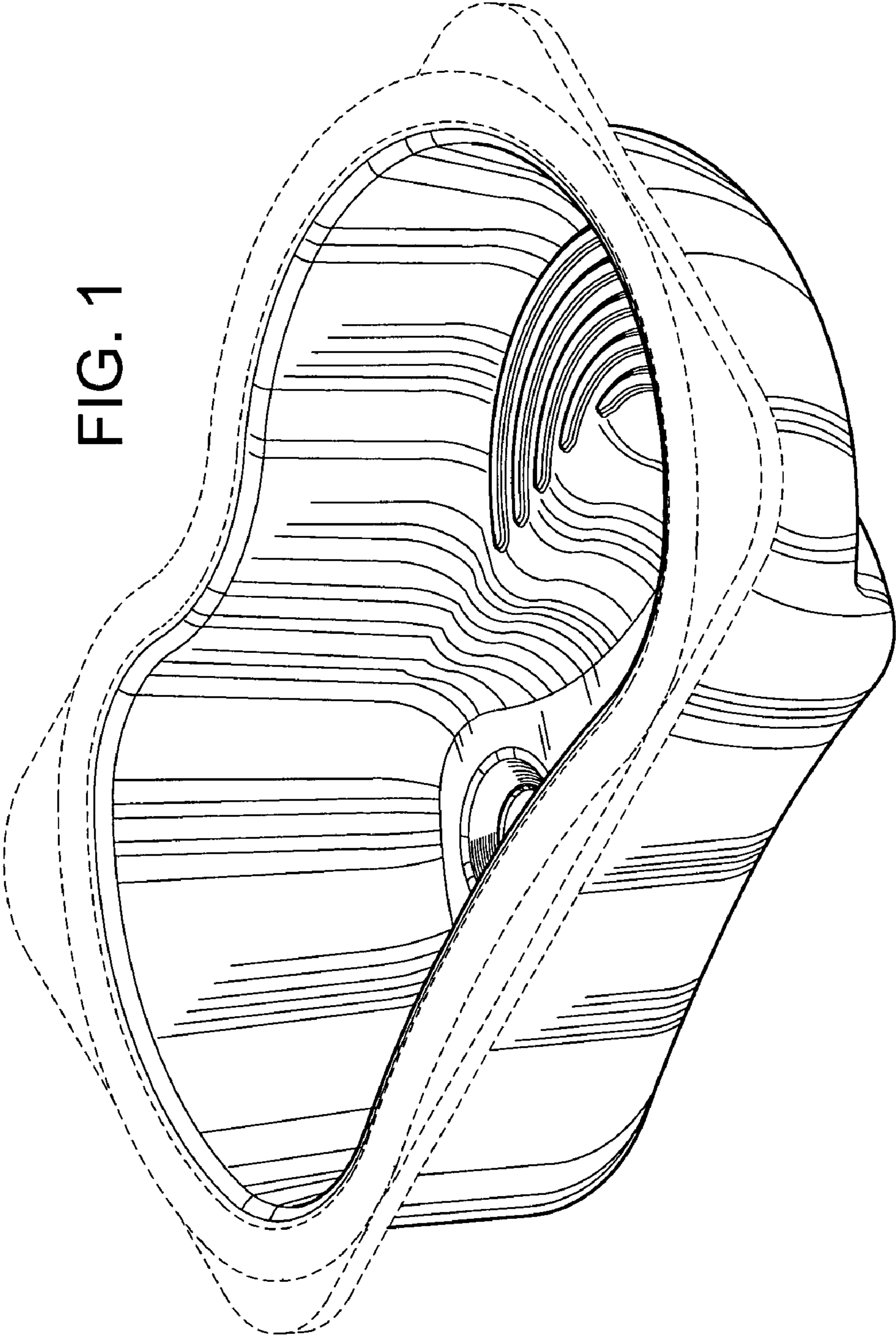

FIG. 1



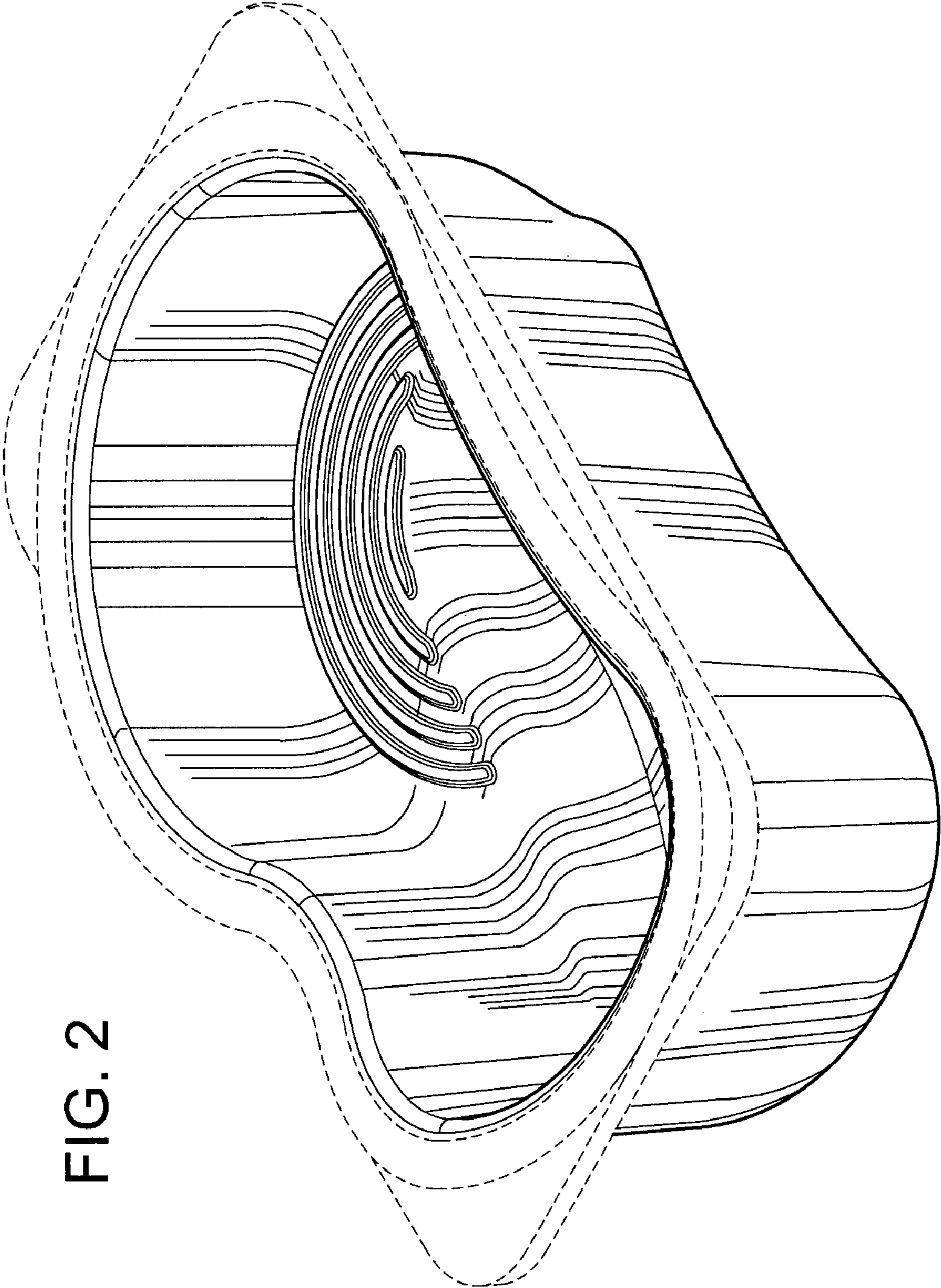

FIG. 2

FIG. 3

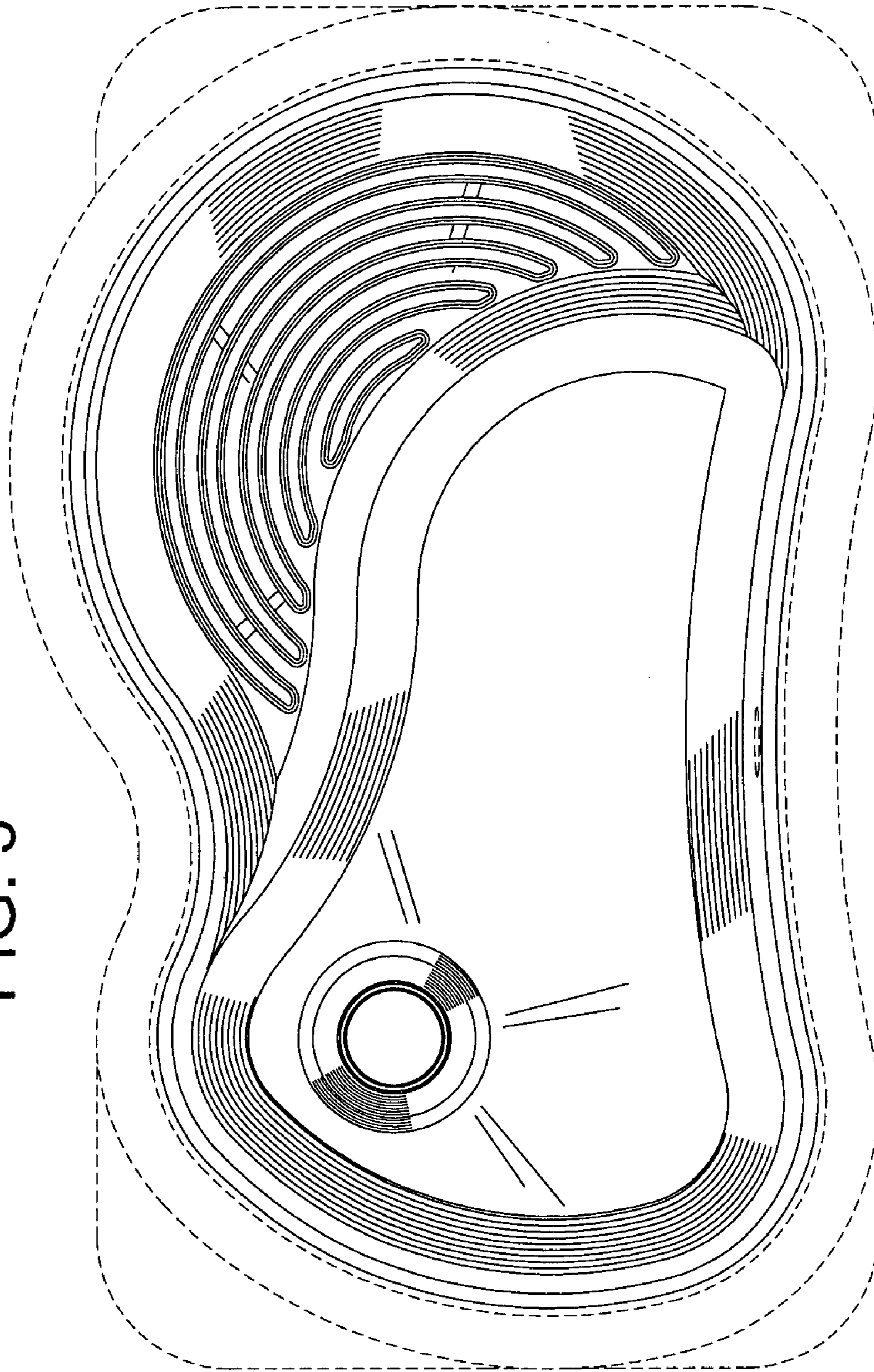
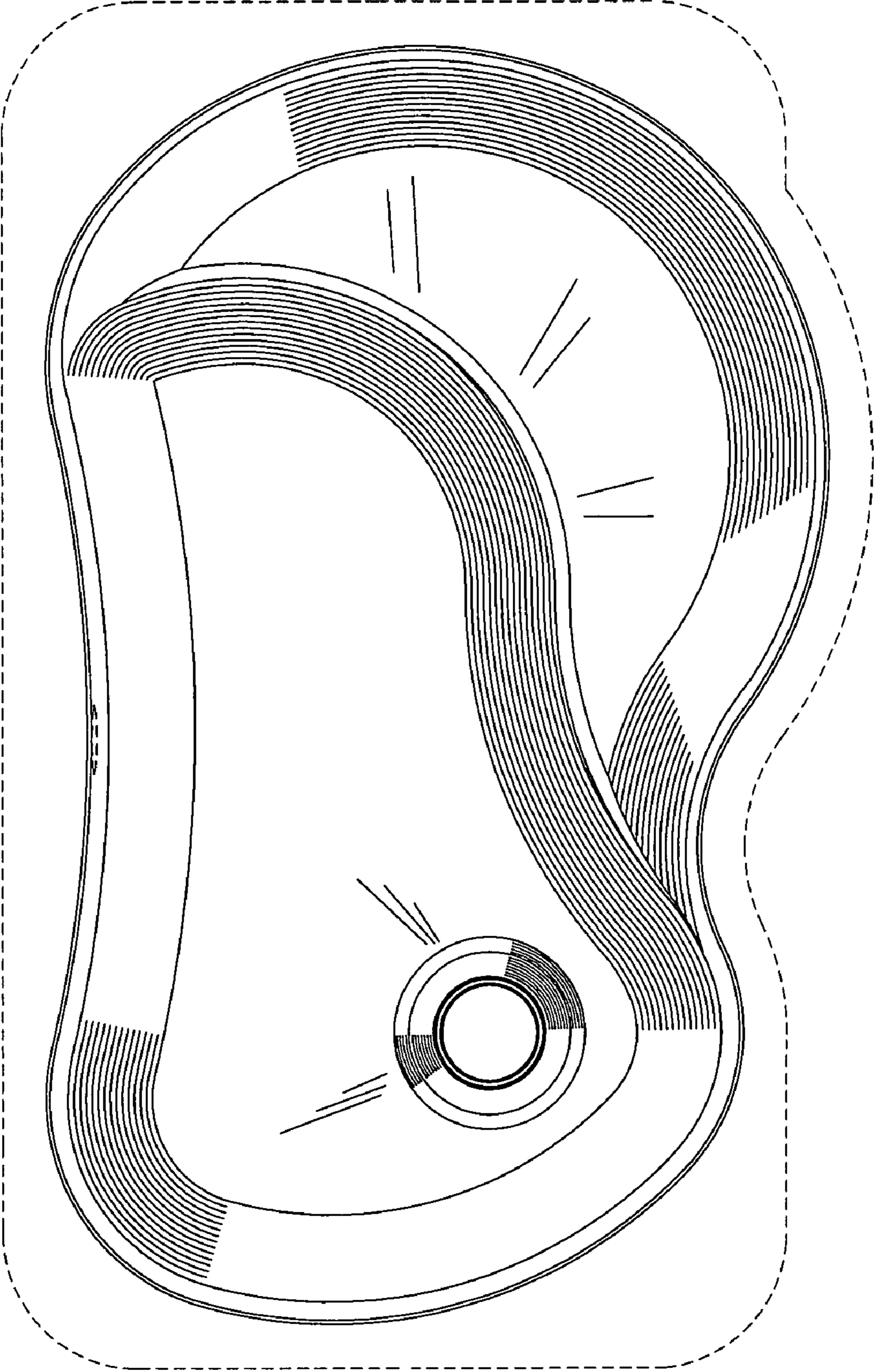

FIG. 4



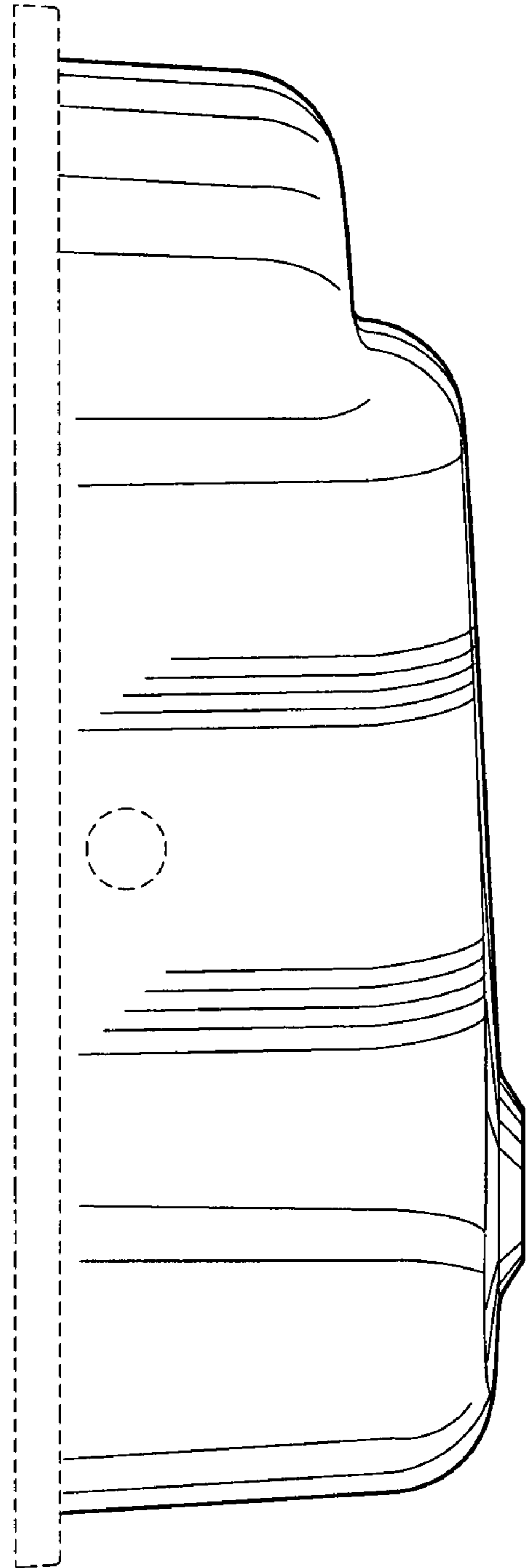

FIG. 5

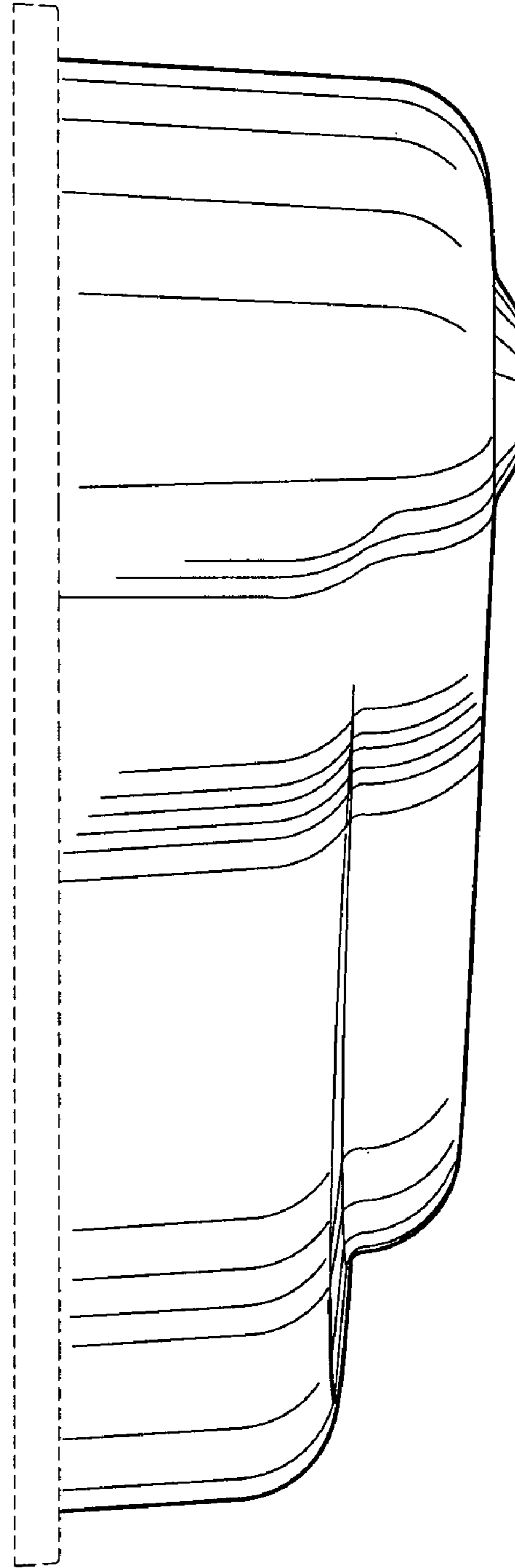

FIG. 6

FIG. 7

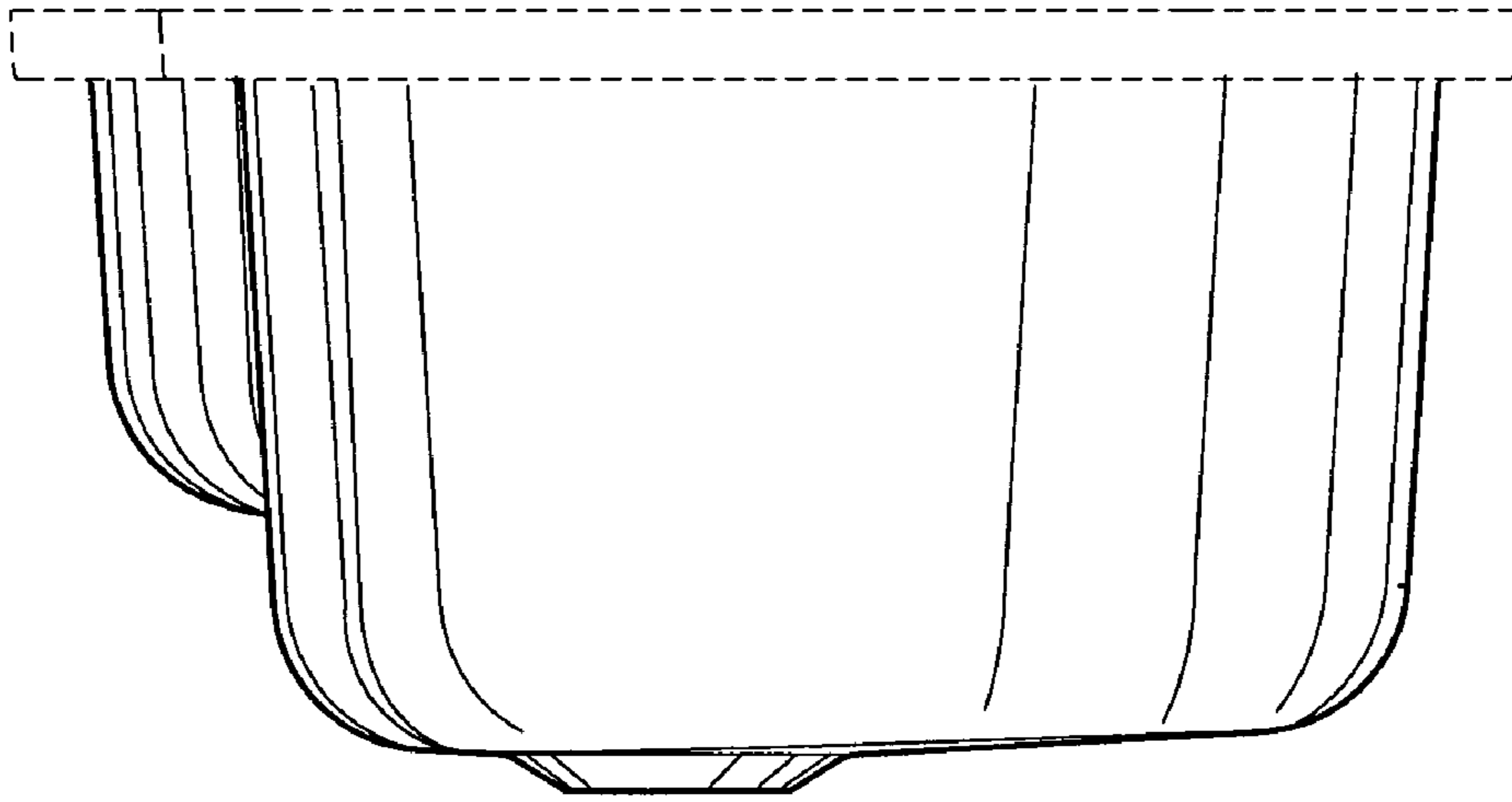
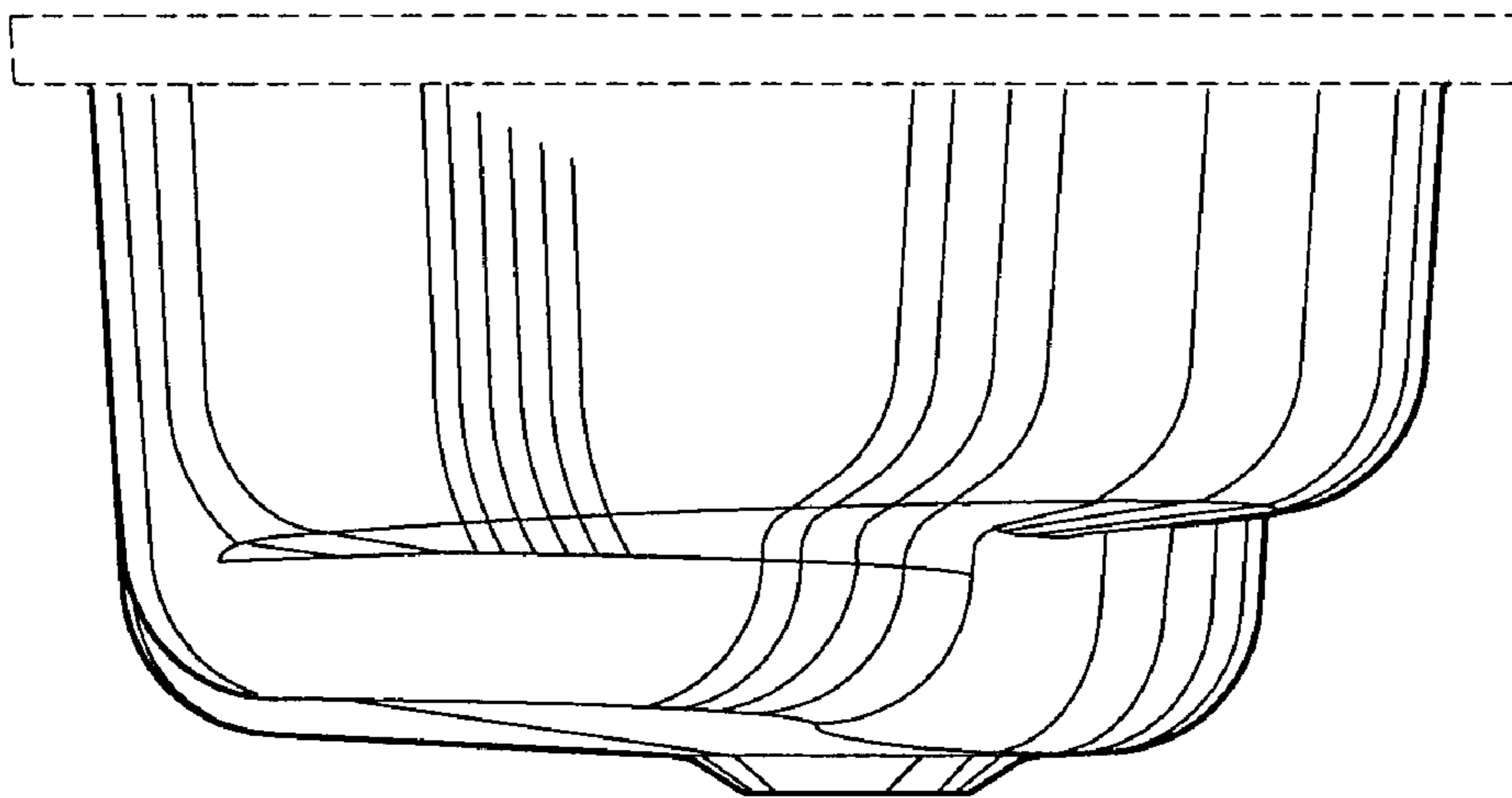

FIG. 8



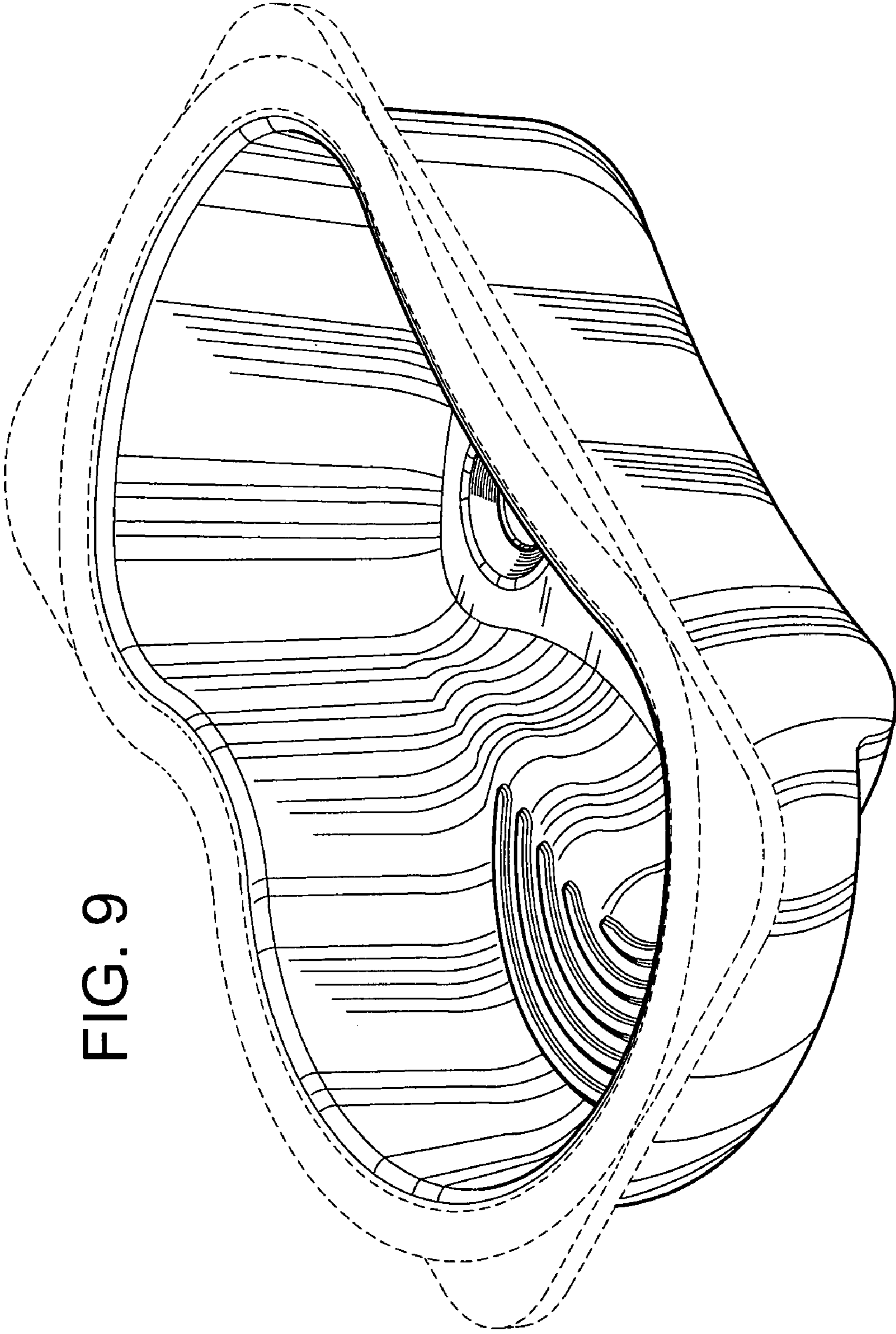

FIG. 9

FIG. 10

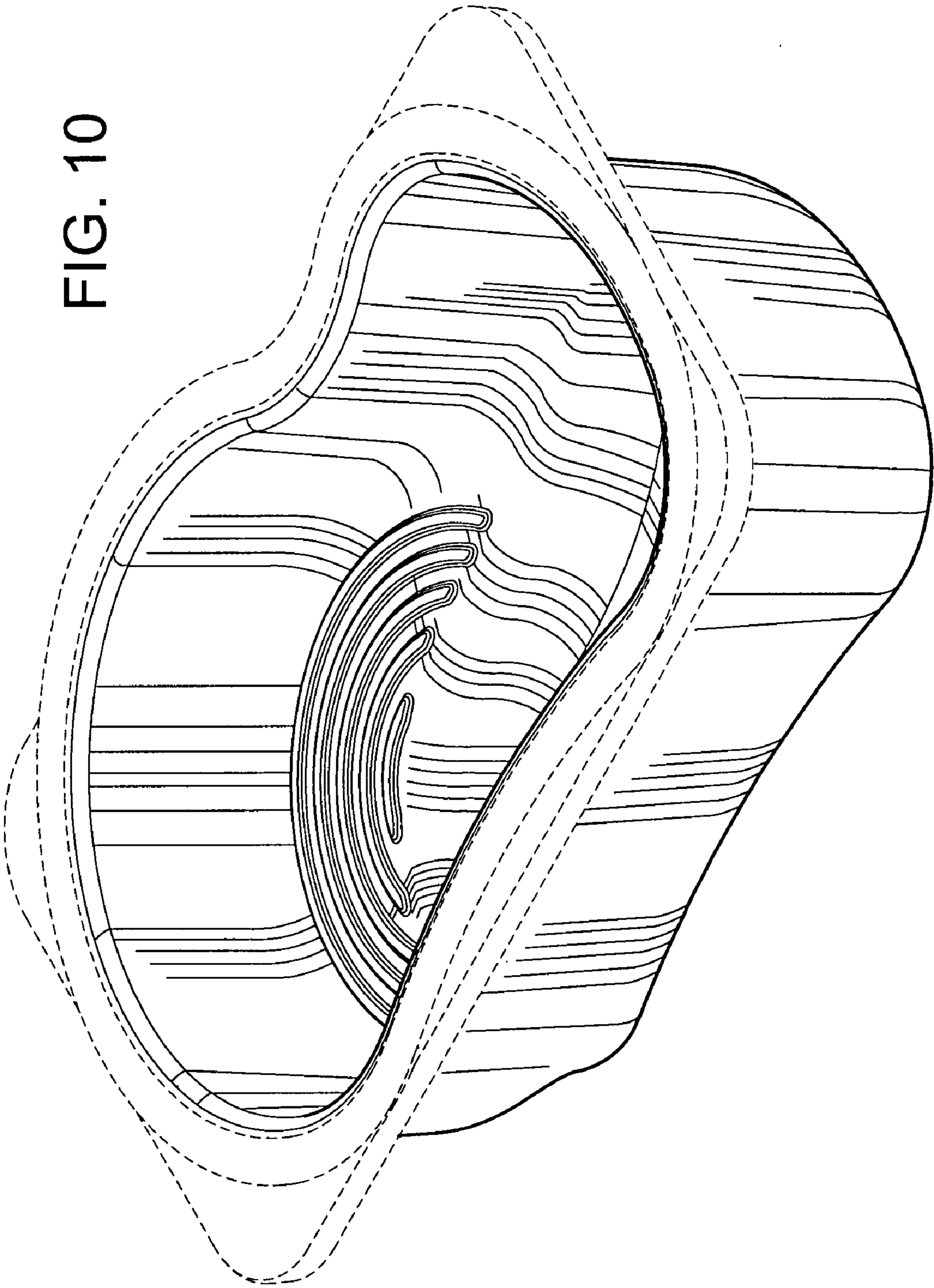

FIG. 11

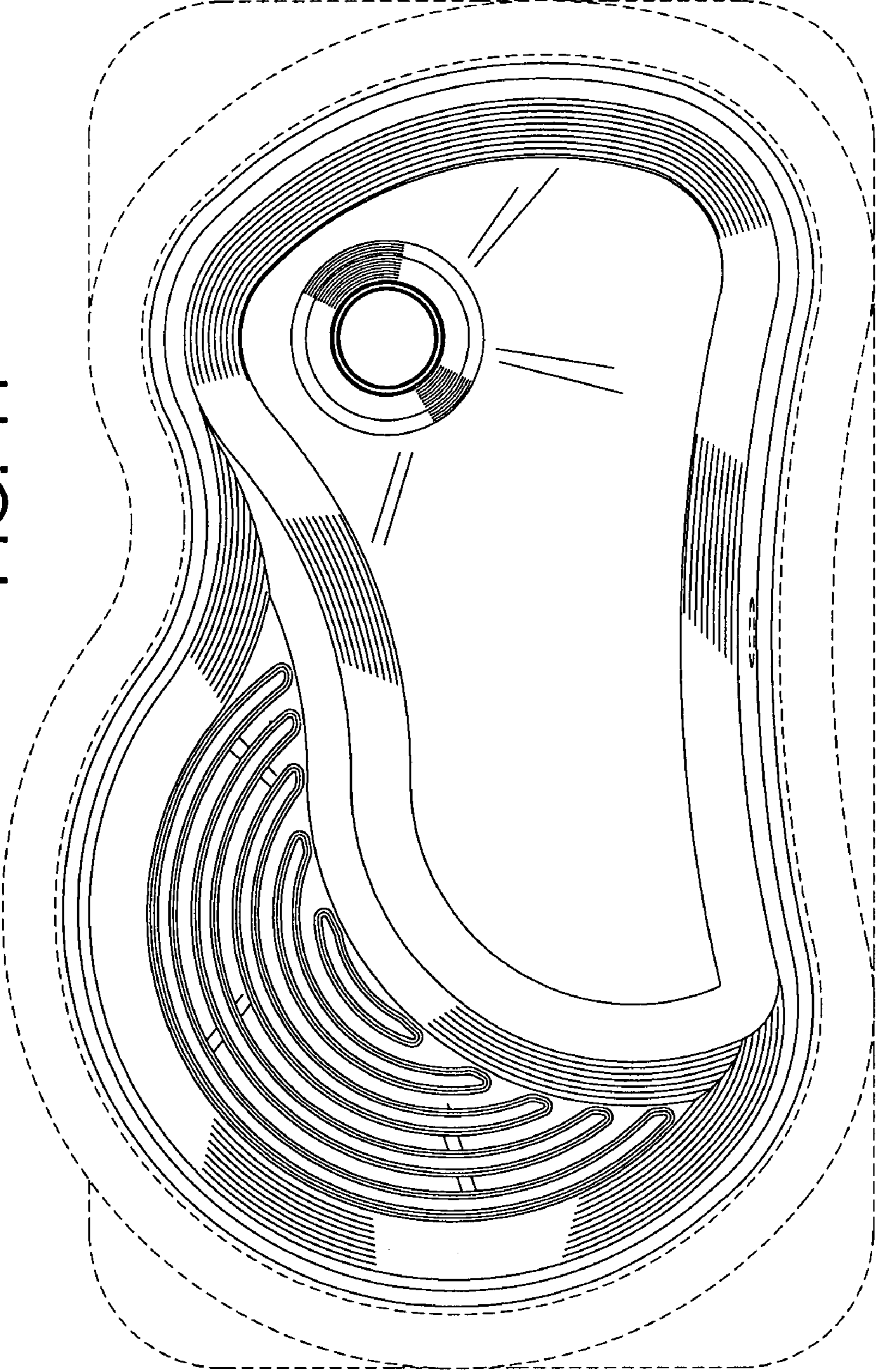

FIG. 12

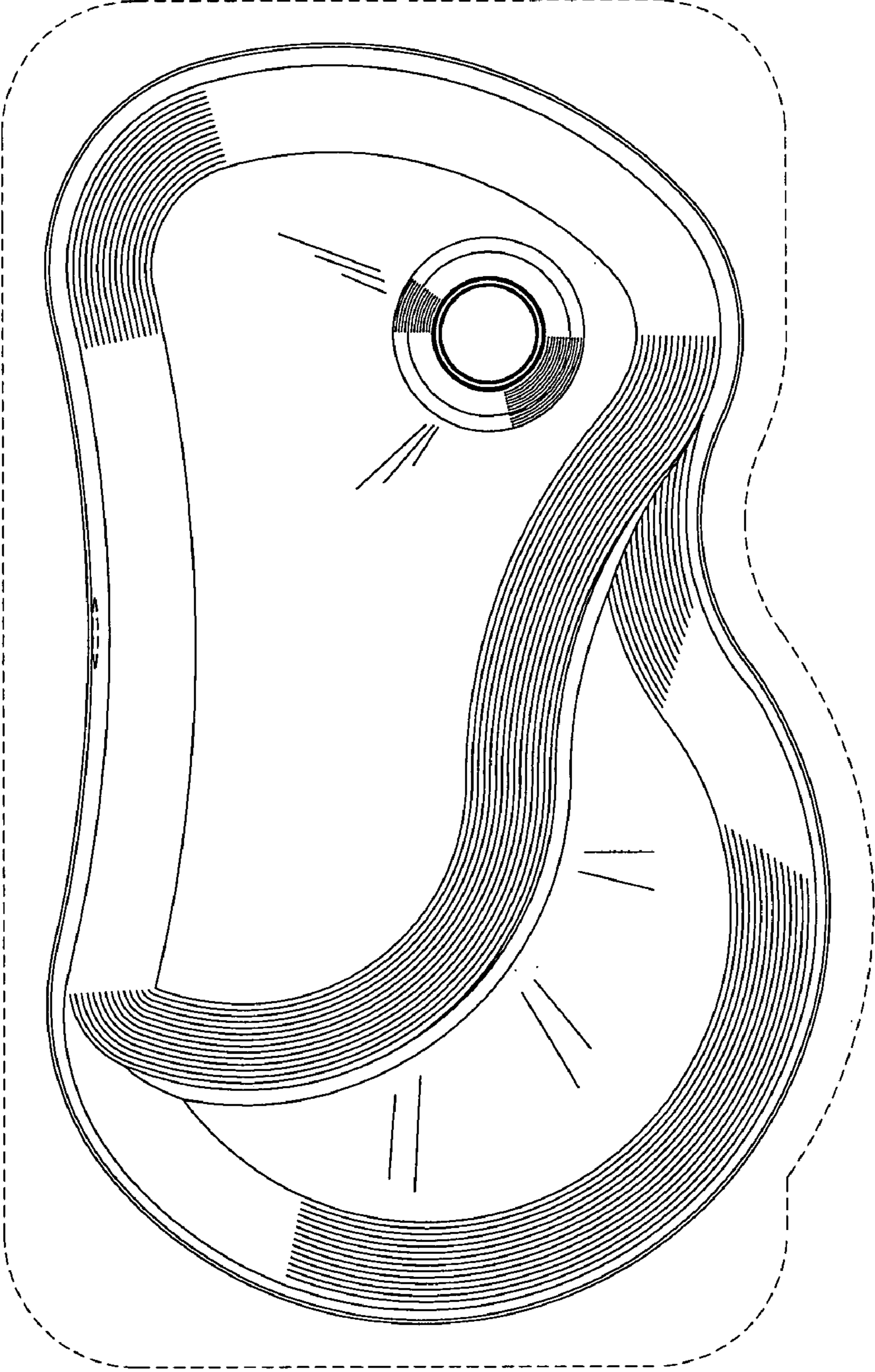

FIG. 13

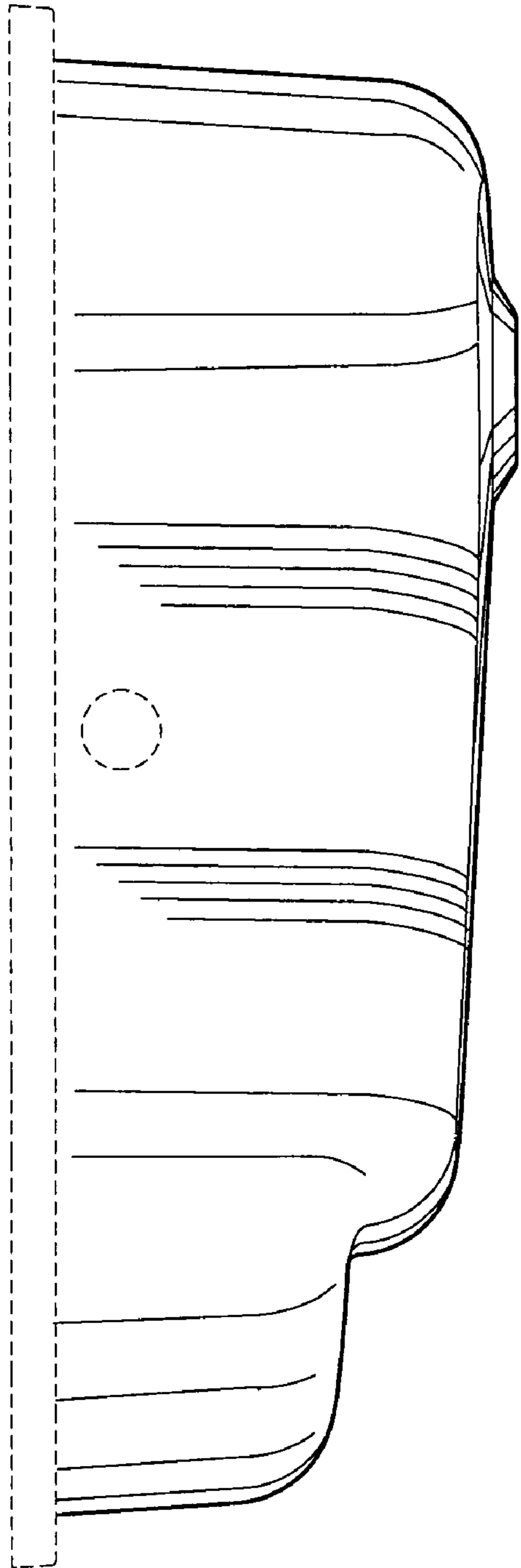

FIG. 14

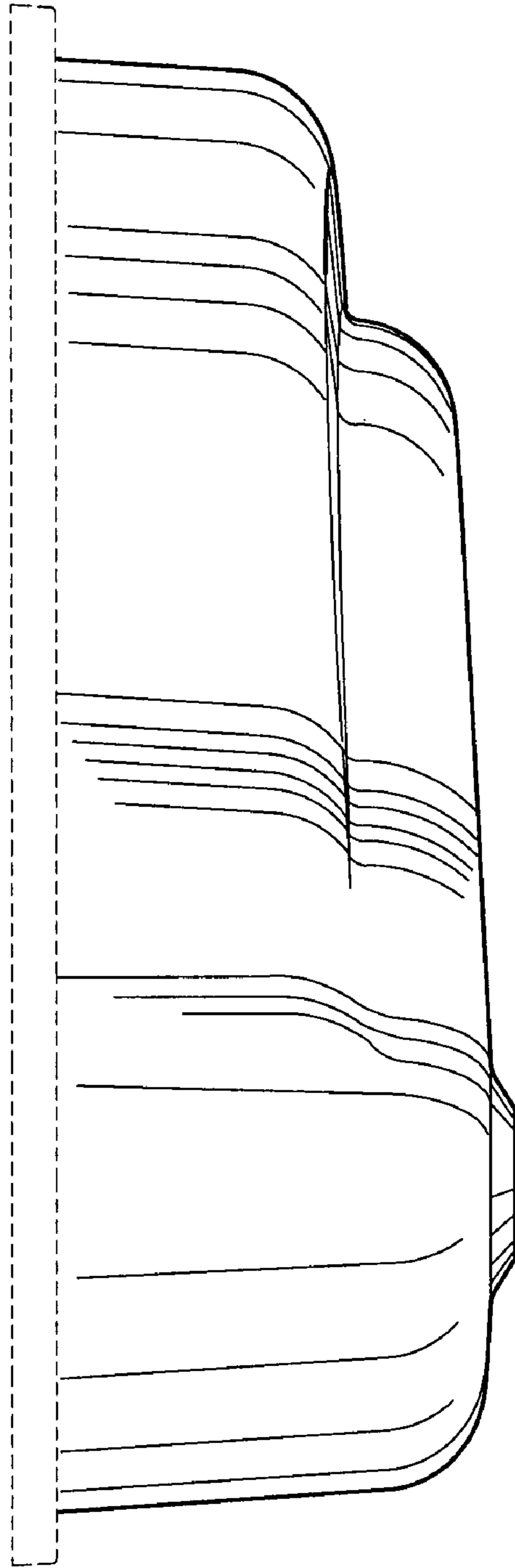

FIG. 15

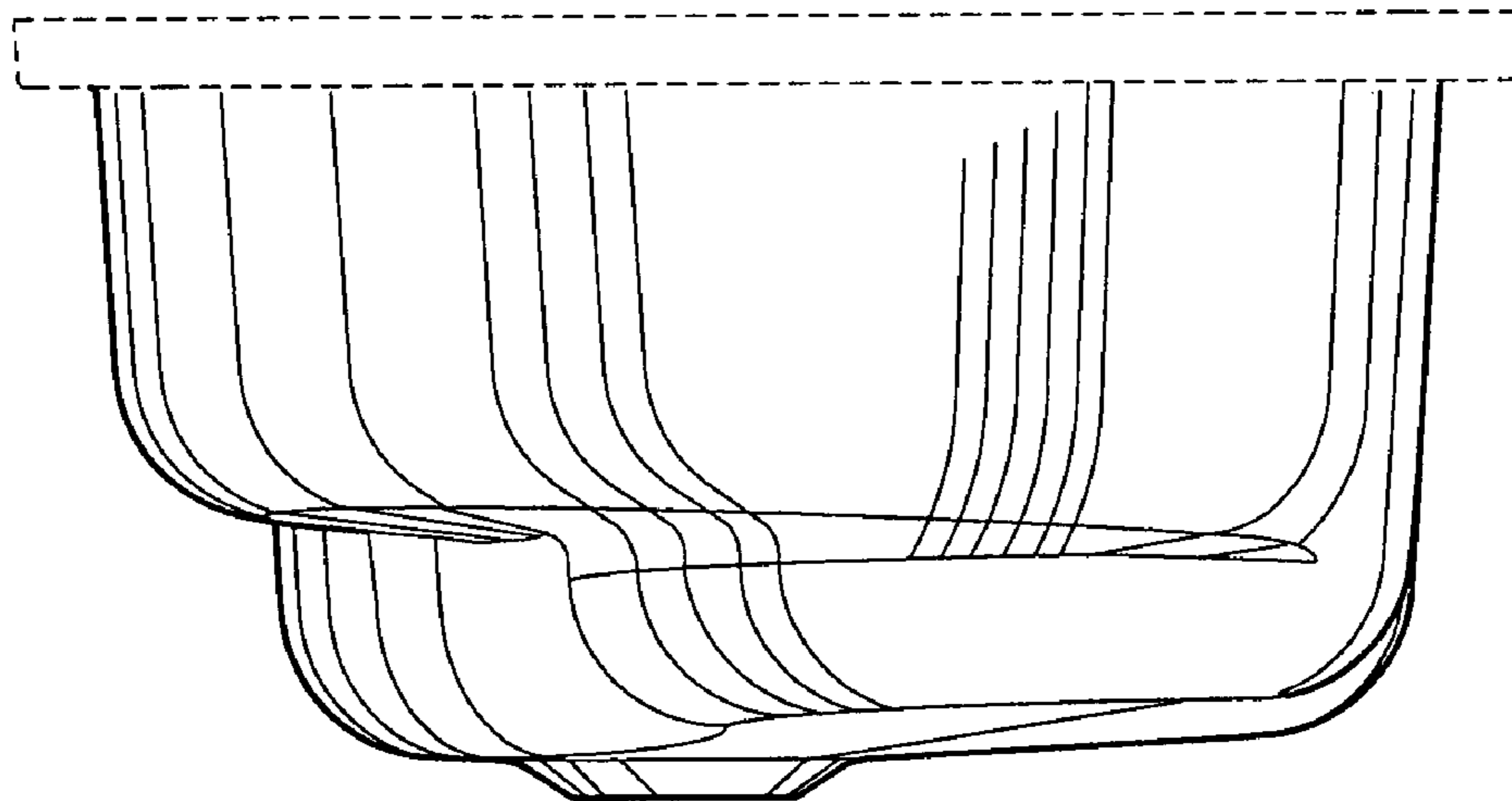

FIG. 16

