



US00D551726S

(12) **United States Design Patent**
Pierce

(10) **Patent No.:** **US D551,726 S**

(45) **Date of Patent:** **** Sep. 25, 2007**

(54) **TRAINING BASKETBALL**

(76) Inventor: **Ricky Charles Pierce**, 5219 Cook La.,
Sugarland, TX (US) 77479

(**) Term: **14 Years**

(21) Appl. No.: **29/229,929**

(22) Filed: **May 13, 2005**

Related U.S. Application Data

(63) Continuation-in-part of application No. 29/186,124, filed on
Jul. 9, 2003.

(51) **LOC (8) Cl.** **21-02**

(52) **U.S. Cl.** **D21/713; D21/781**

(58) **Field of Classification Search** D21/707-714;
473/422, 472, 569-614; 40/327; 434/248;
D19/59

See application file for complete search history.

(56) **References Cited**

U.S. PATENT DOCUMENTS

2,223,271	A	*	11/1940	Robinson	473/587
2,263,052	A	*	11/1941	Ross	473/128
2,472,406	A	*	6/1949	Darula, Jr.	473/128
3,110,494	A	*	11/1963	Morgan	473/458
3,563,548	A	*	2/1971	Tolotti	473/588
3,858,876	A		1/1975	Williams		
D329,674	S	*	9/1992	Williams	D21/714
5,158,284	A	*	10/1992	Vogl	473/594
5,228,687	A	*	7/1993	Luecke et al.	473/596

(Continued)

FOREIGN PATENT DOCUMENTS

DE	3101088	A1	*	8/1982
EP	000121660		*	1/2004

OTHER PUBLICATIONS

SPORTIME (R) Fall 2002 Catalog, p. 70. "Mr. Marv's
Perfect Shot with cellular ultra grip rubber".*

Primary Examiner—Catherine Tuttle

(74) *Attorney, Agent, or Firm*—Jennifer S. Sickler; Jason P.
Sander; Gardere Wynne Sewell LLP

(57) **CLAIM**

The ornamental design for a training basketball, as shown
and described.

DESCRIPTION

FIG. 1 is an upper right front perspective view showing my
new design embodied in a training basketball for a right
handed person;

FIG. 2 is a front view of FIG. 1;

FIG. 3 is a rear view of FIG. 2;

FIG. 4 is a right side view of FIG. 2;

FIG. 5 is a left side view of FIG. 2;

FIG. 6 is a bottom view of FIG. 2;

FIG. 7 is a top view of FIG. 2;

FIG. 8 is an upper left front perspective view showing my
new design embodied in a training basketball for a left
handed person;

FIG. 9 is a front view of FIG. 8;

FIG. 10 is a rear view of FIG. 9;

FIG. 11 is a left side view of FIG. 9;

FIG. 12 is a right side view of FIG. 9;

FIG. 13 is a bottom view of FIG. 9;

FIG. 14 is a top view of FIG. 9;

FIG. 15 is a cross sectional view taken along line 15—15 of
FIG. 5; the indent section shown being representative of the
lengthwise cross section of all of the indentations, except for
the specific variations in their proportional lengths in the
preceding figures; and,

FIG. 16 is a cross sectional view taken along line 16—16 of
FIG. 12, the indent section shown being representative of the
widthwise cross section of all of the indentations, except for
the specific variations in their proportional widths as shown
in the preceding figures.

The broken lines showing the human hands in FIGS. 1 and
8 are included for the purpose of illustrating the environment
of the design and form no part of the claimed design.

1 Claim, 8 Drawing Sheets

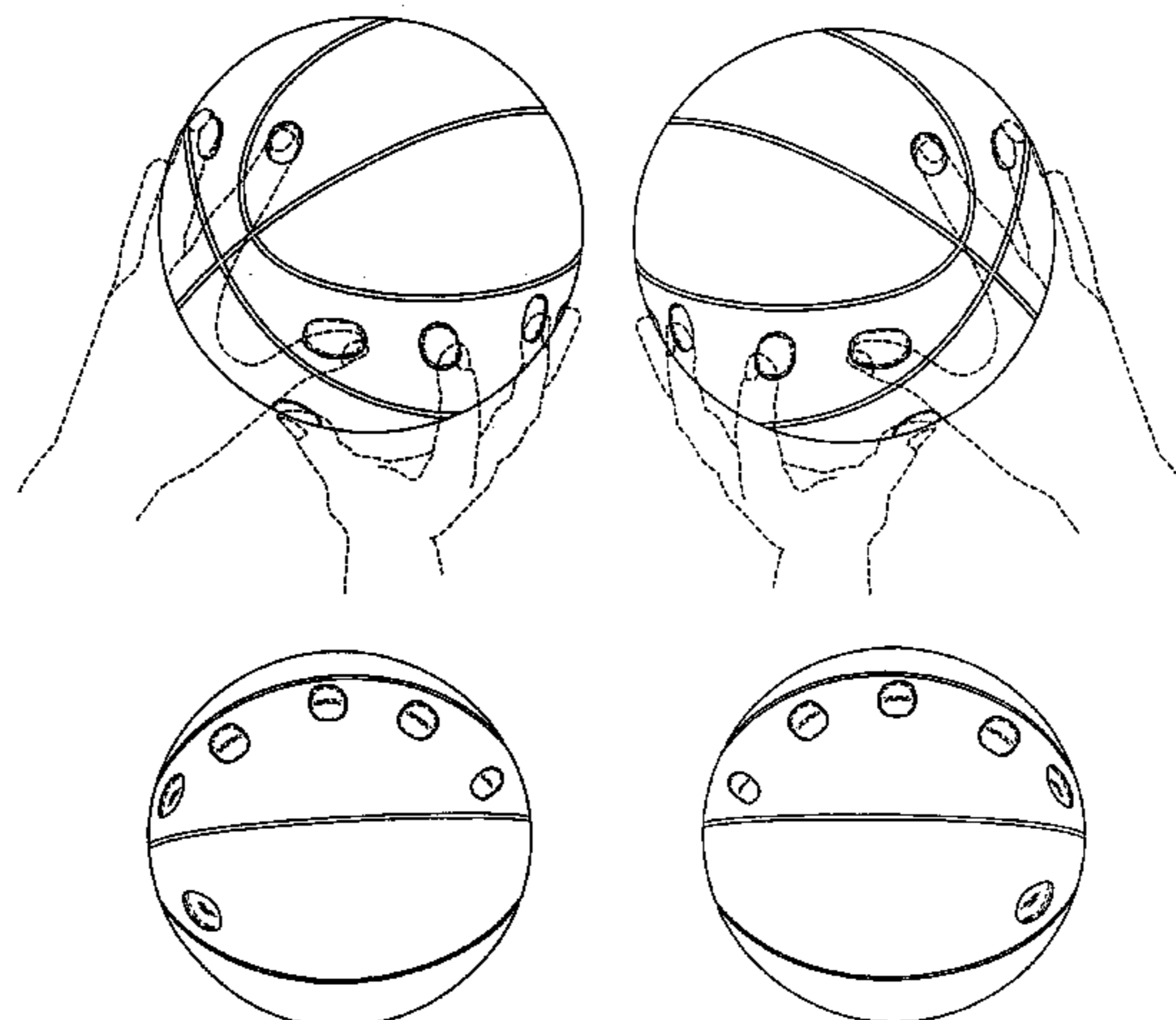

US D551,726 S

Page 2

U.S. PATENT DOCUMENTS

5,407,193	A	*	4/1995	McGinley	473/451							
D386,228	S	*	11/1997	Hegenbarth et al.	D21/714							
D387,403	S	*	12/1997	Hegenbarth et al.	D21/714							
5,984,813	A	*	11/1999	Cinnella	473/613							
D483,822	S	*	12/2003	Pelfrey	D21/712							
D485,316	S	*	1/2004	Poegel, Jr.	D21/714							
							D485,590	S	*	1/2004	Poegel, Jr.	D21/714
							6,722,889	B1		4/2004	Pgge et al.		
							7,041,015	B2	*	5/2006	Sowers	473/422
							2003/0181266	A1	*	9/2003	Sowers	473/447
							2004/0076938	A1	*	4/2004	Publicover	434/248
							2005/0113195	A1	*	5/2005	Carbonero	473/596

* cited by examiner

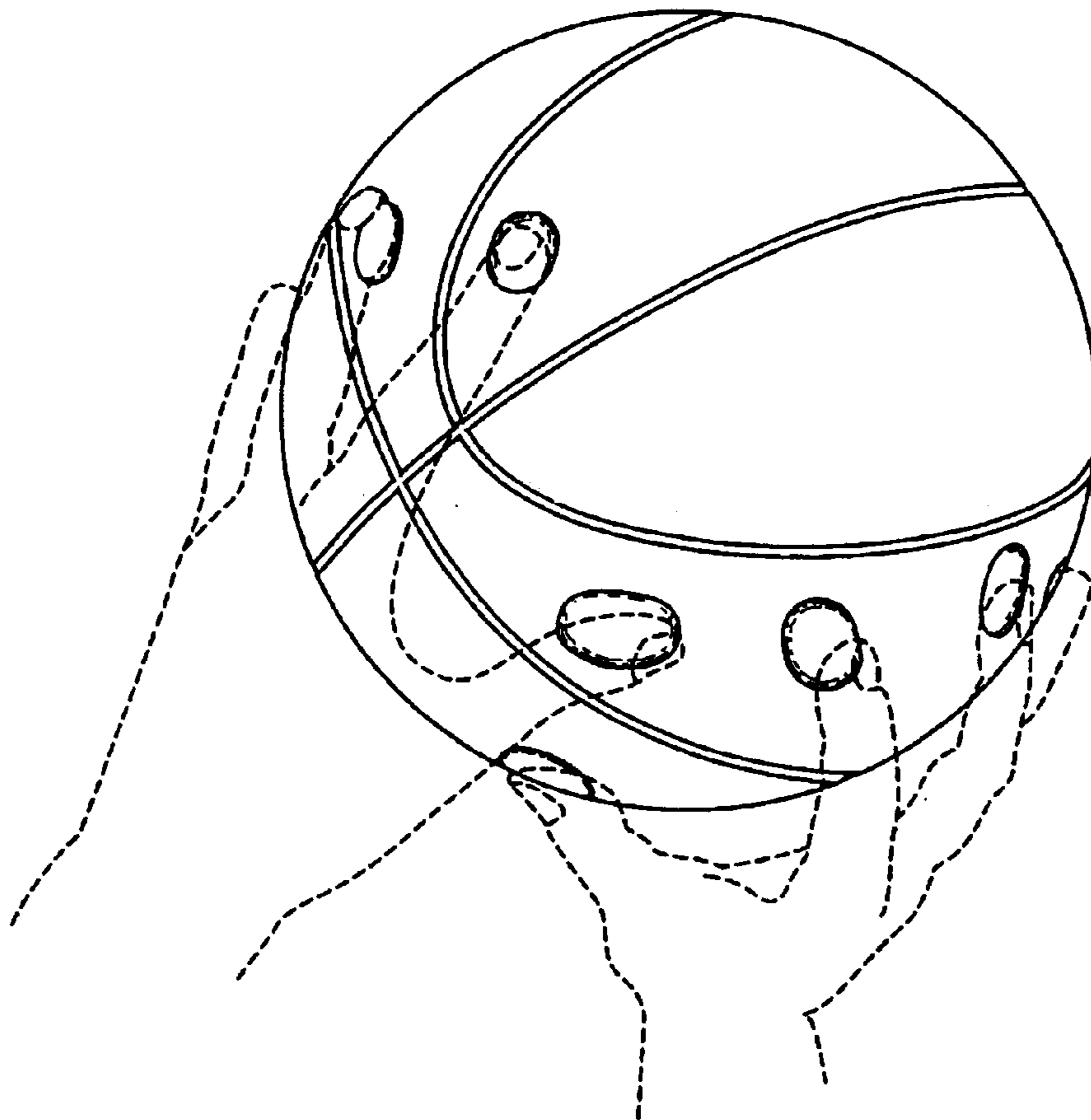

FIG. 1

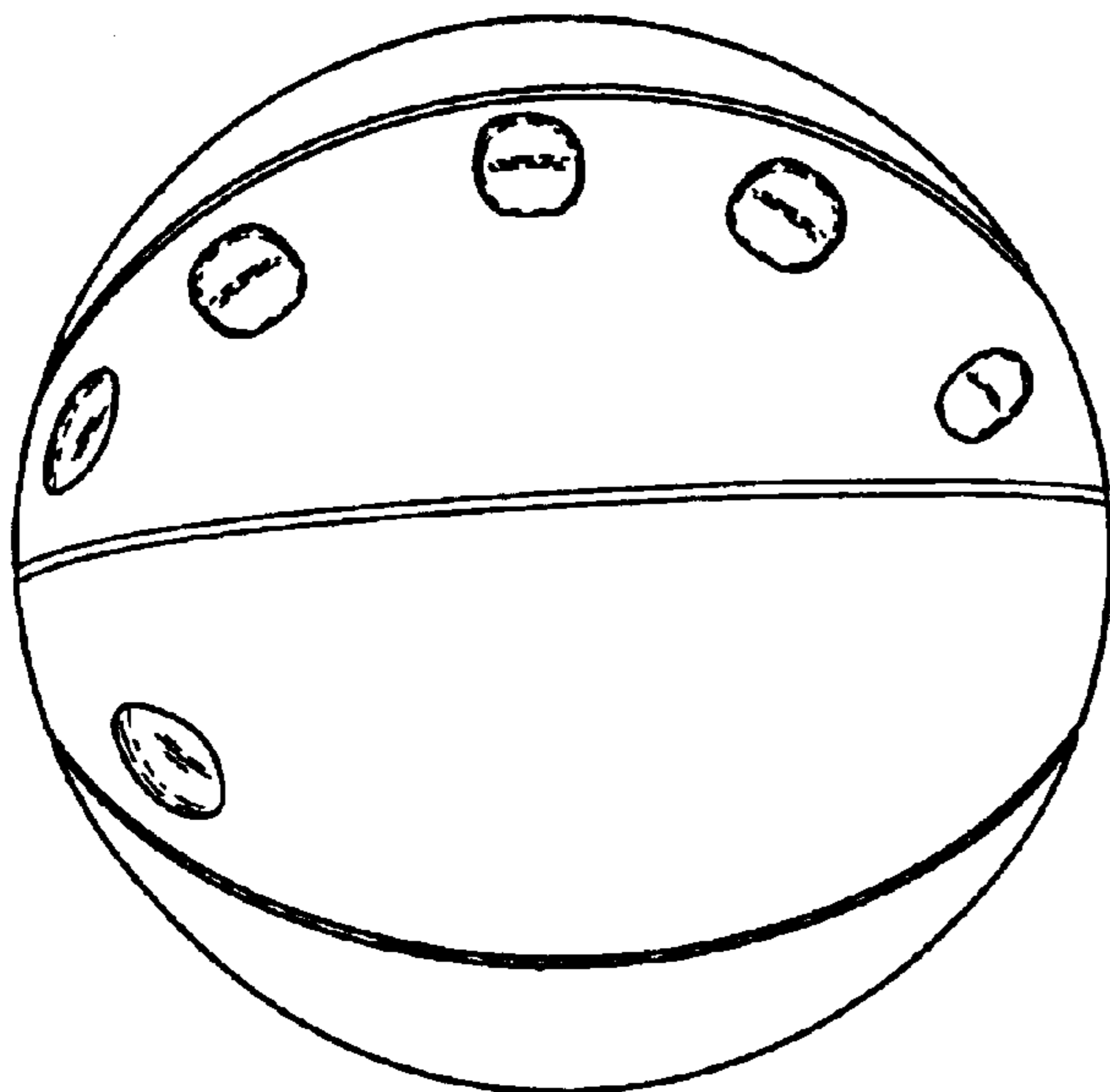

FIG. 2

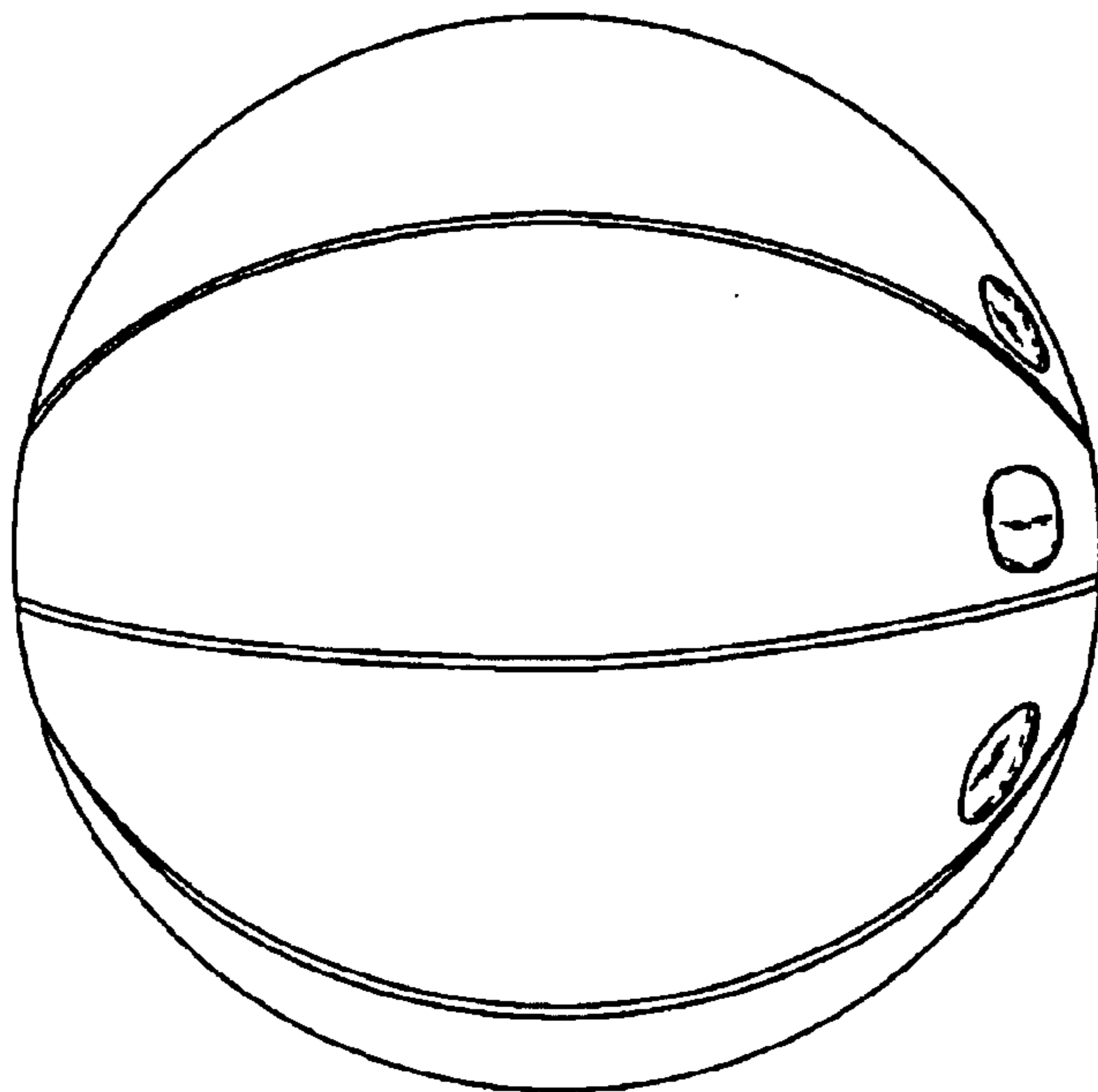

FIG. 3

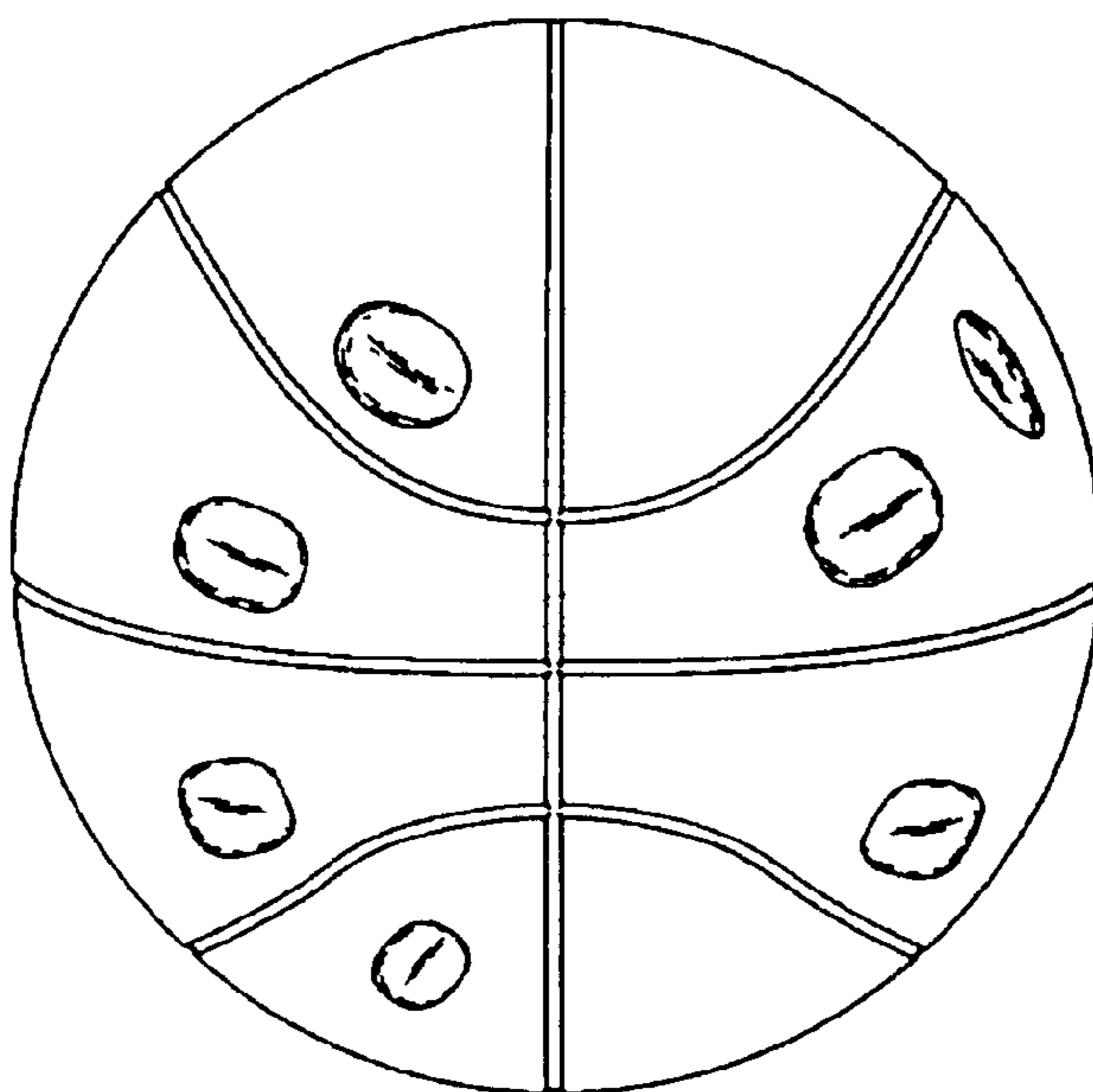

FIG. 4

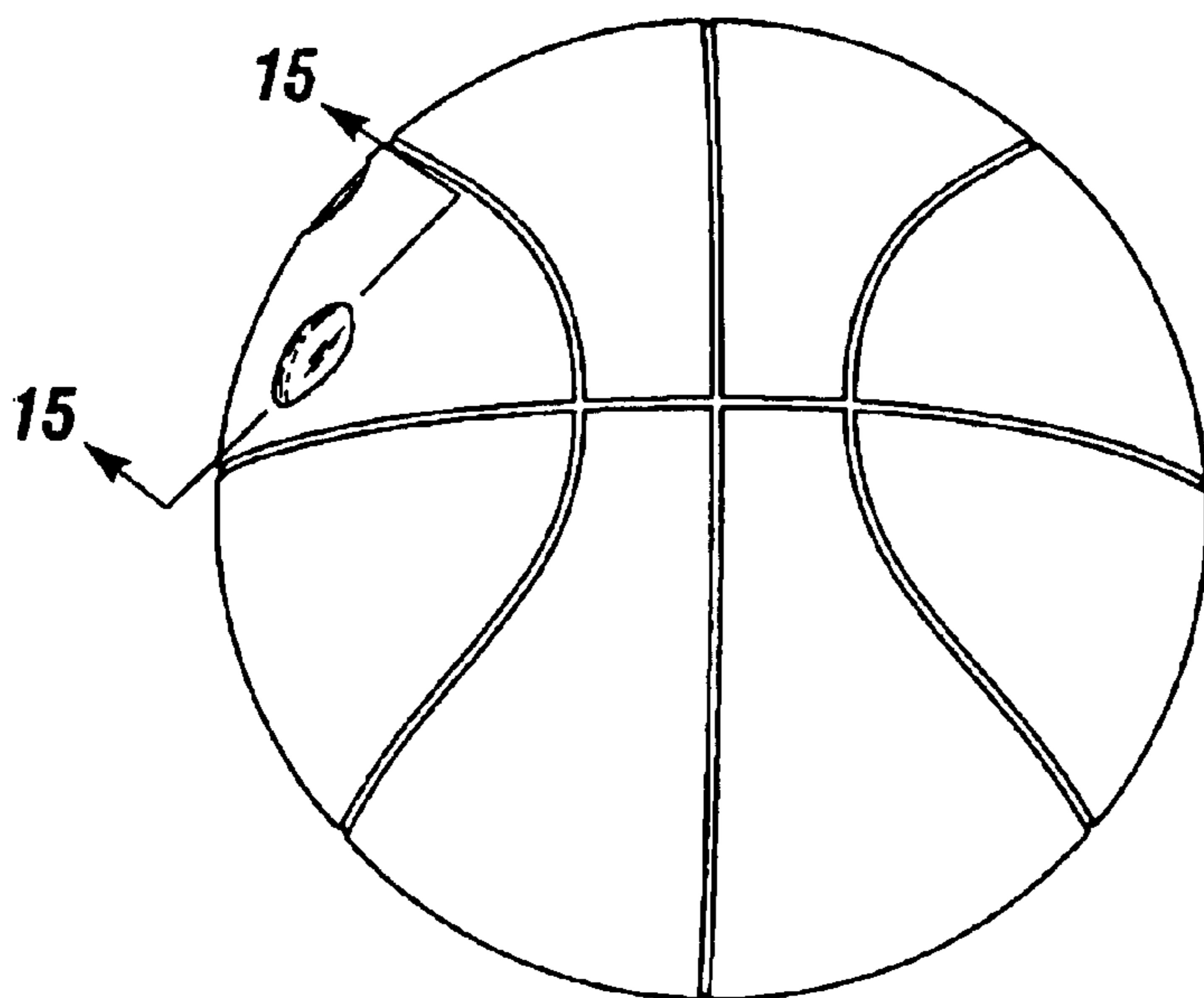

FIG. 5

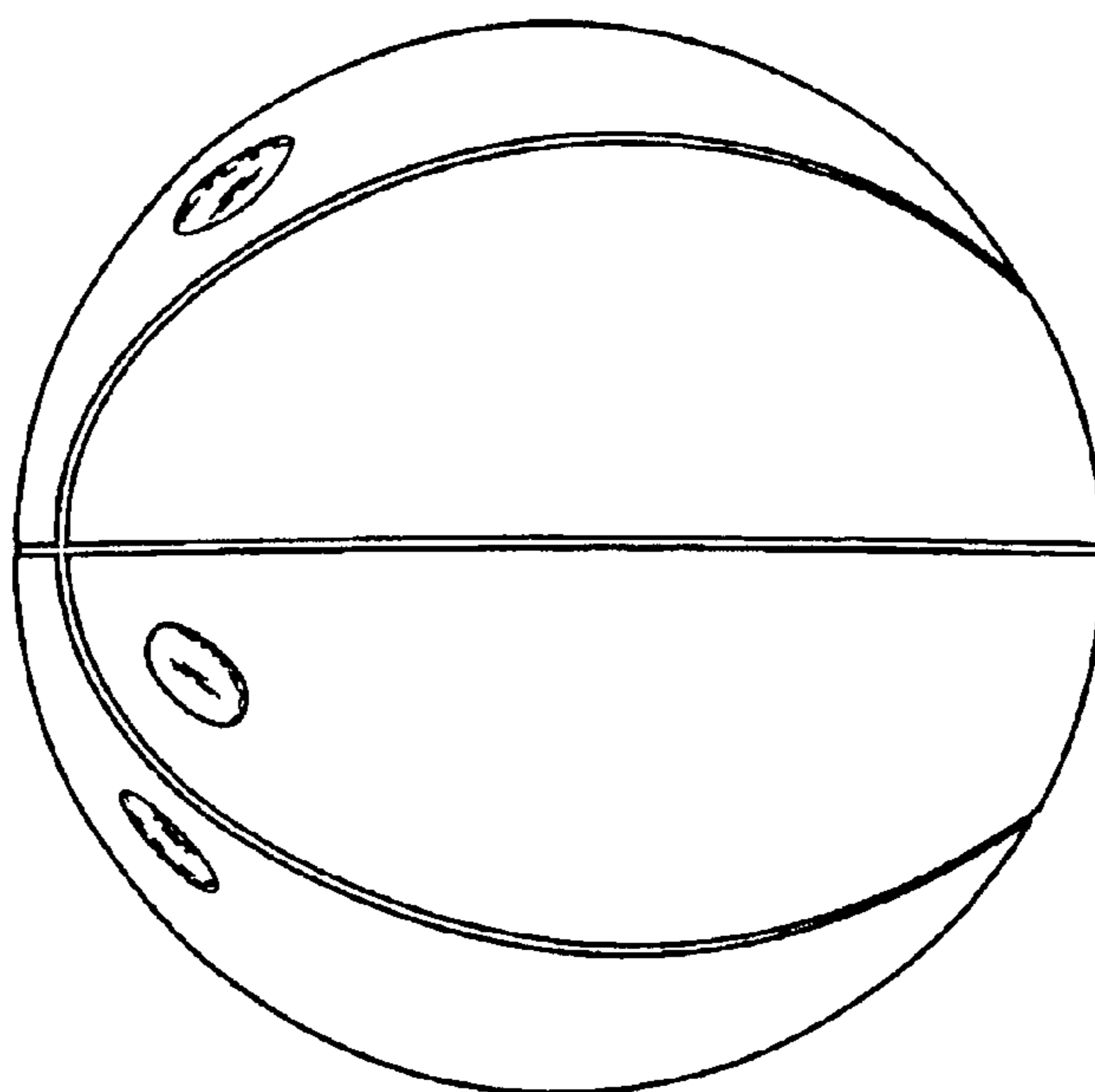

FIG. 6

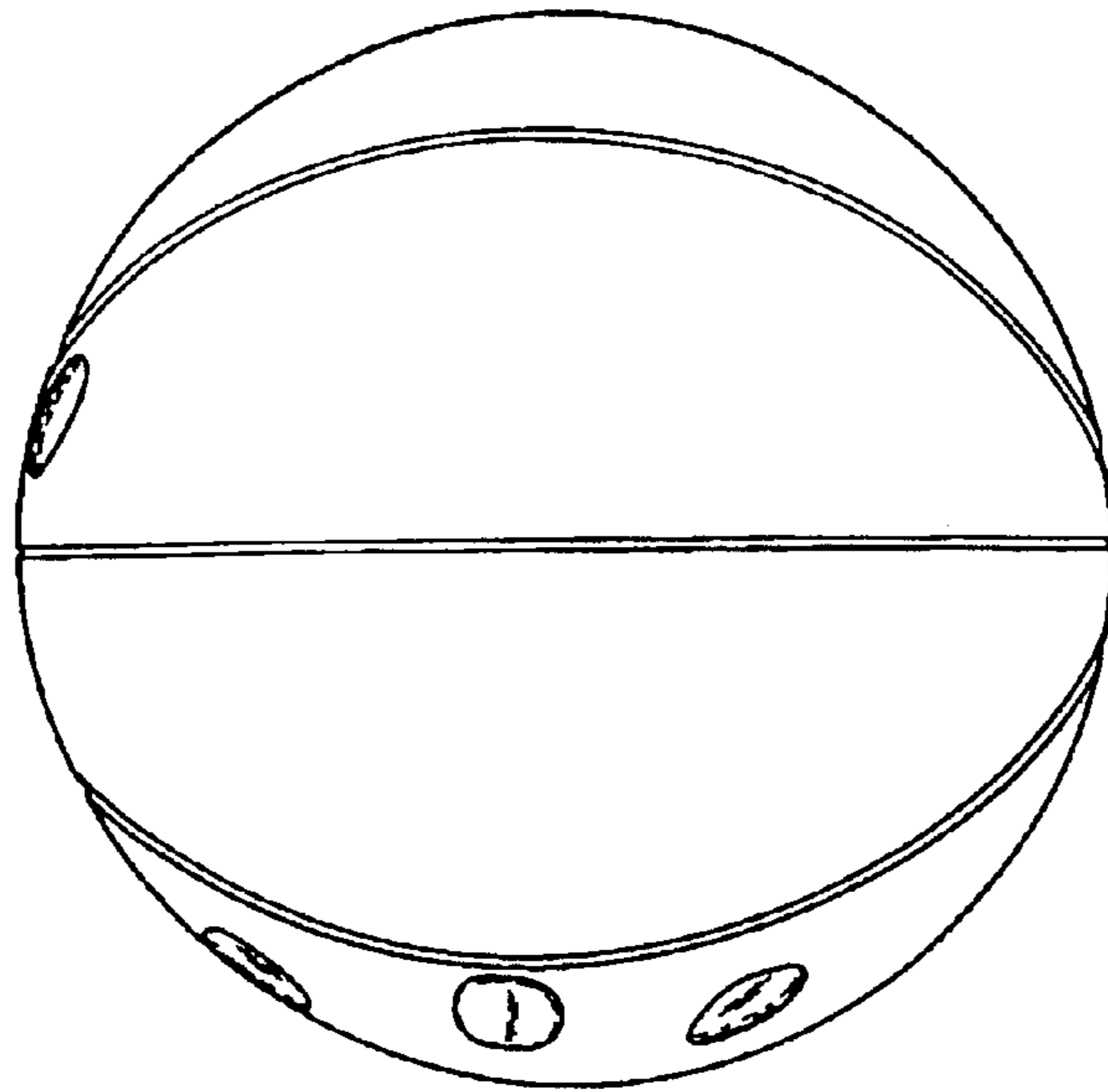

FIG. 7

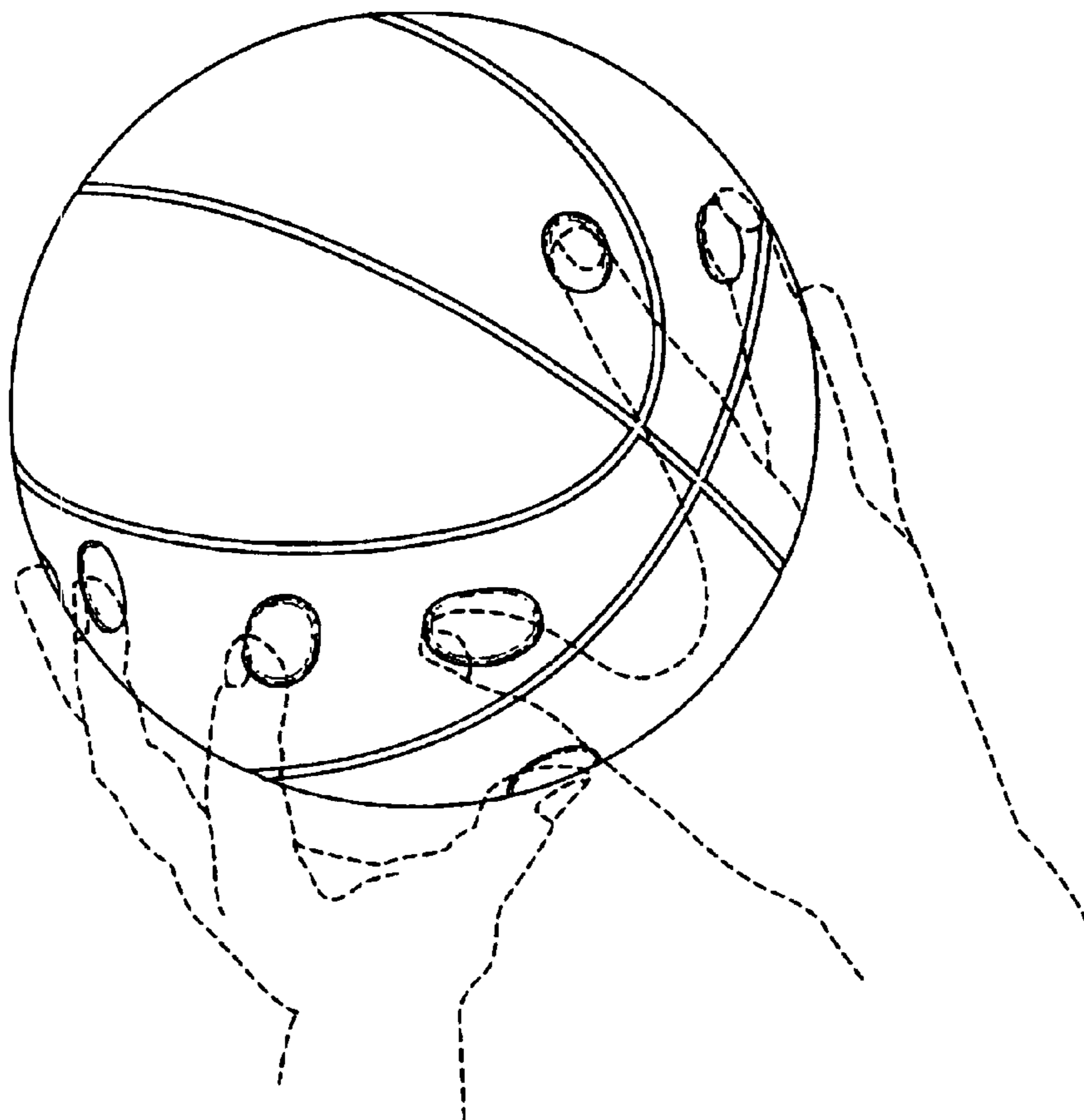

FIG. 8

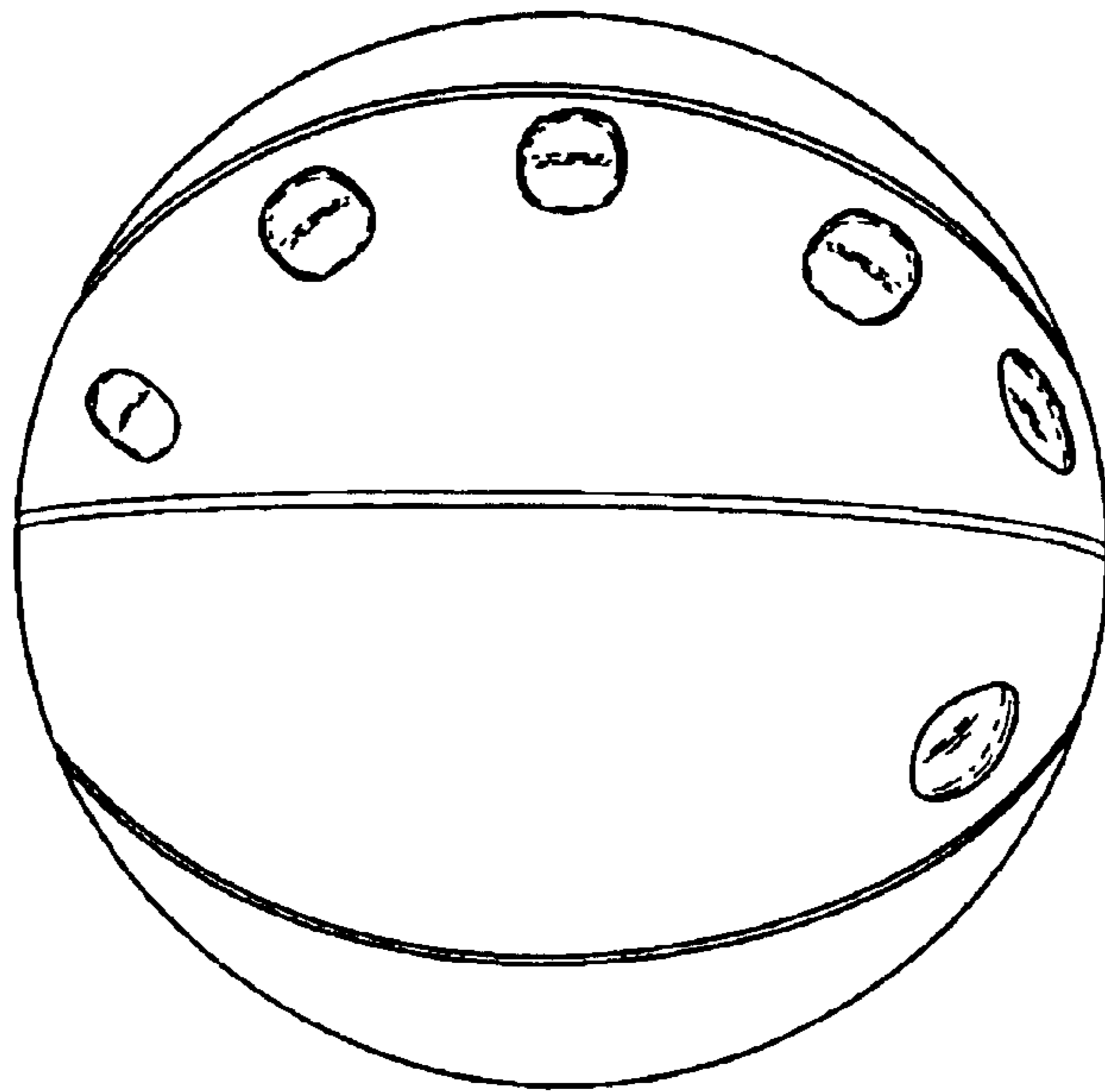

FIG. 9

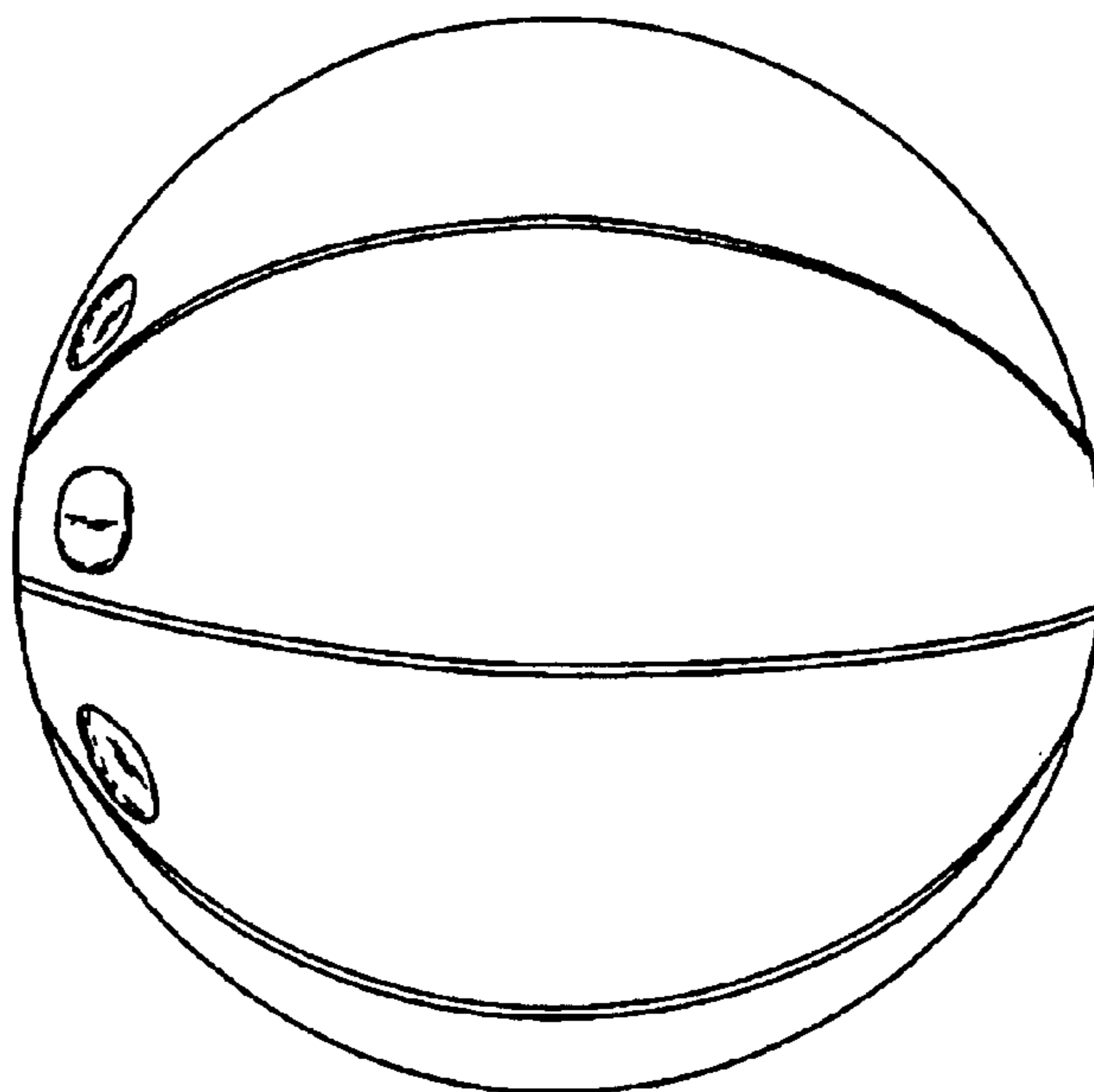

FIG. 10

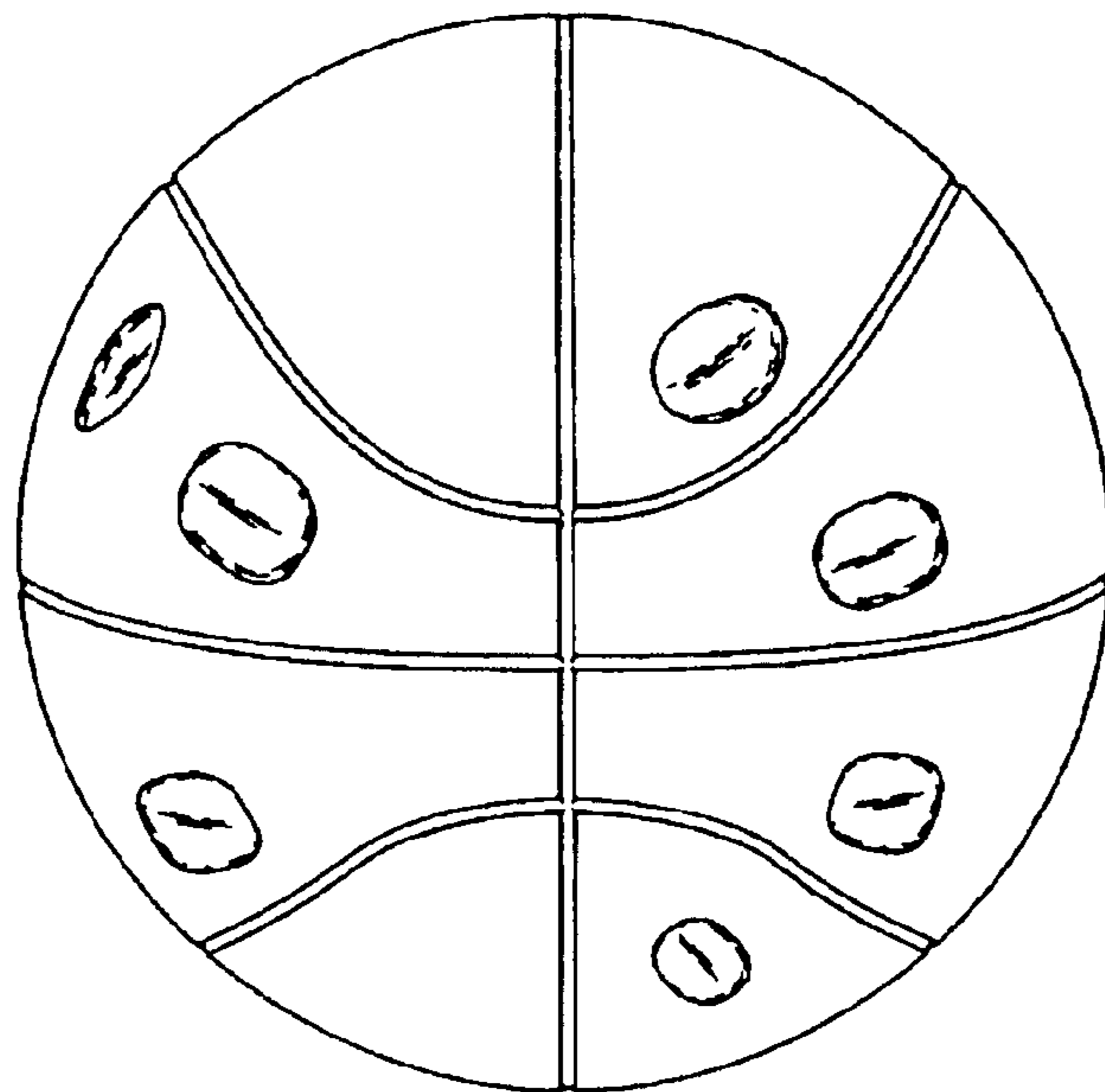

FIG. 11

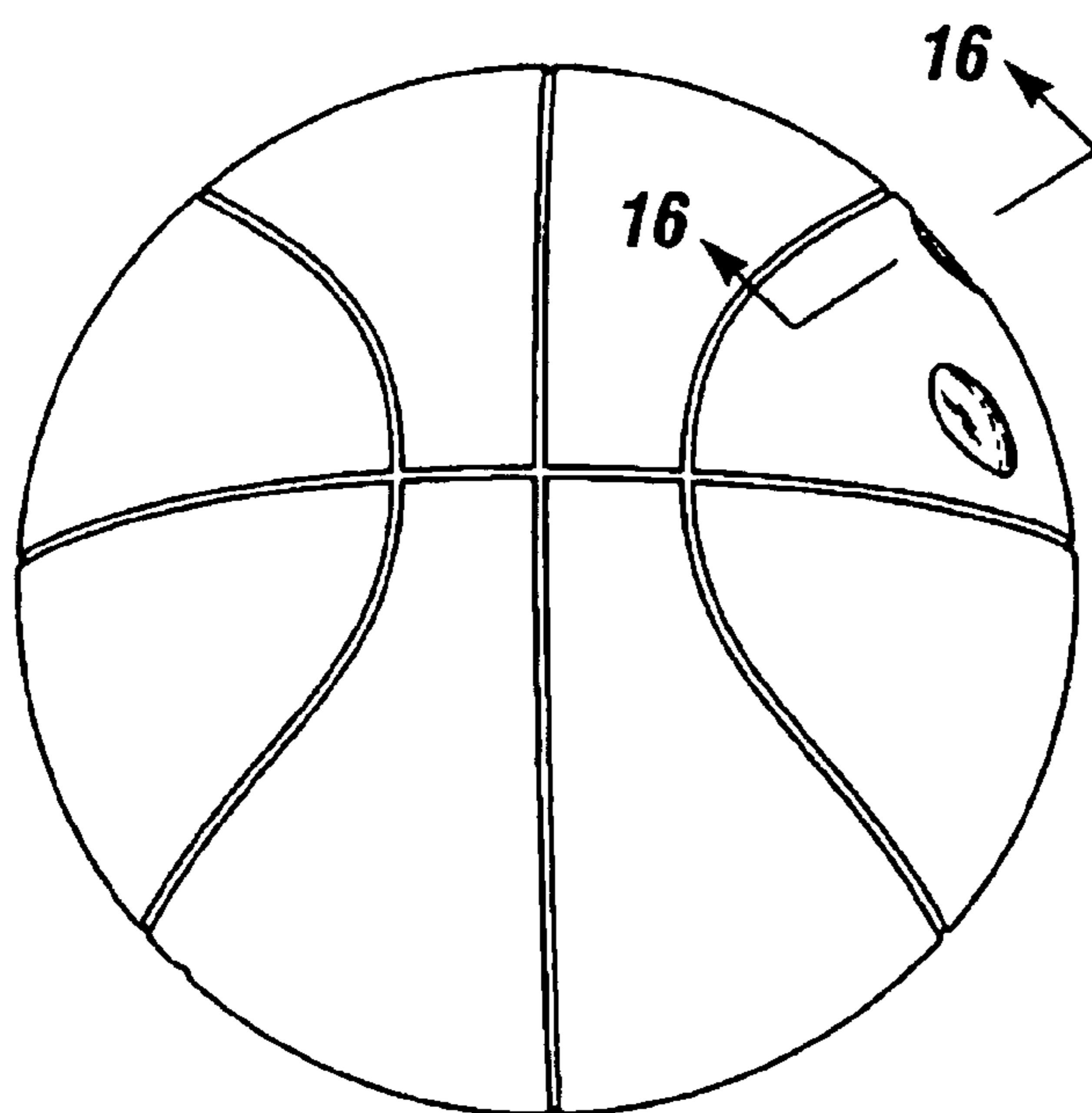

FIG. 12

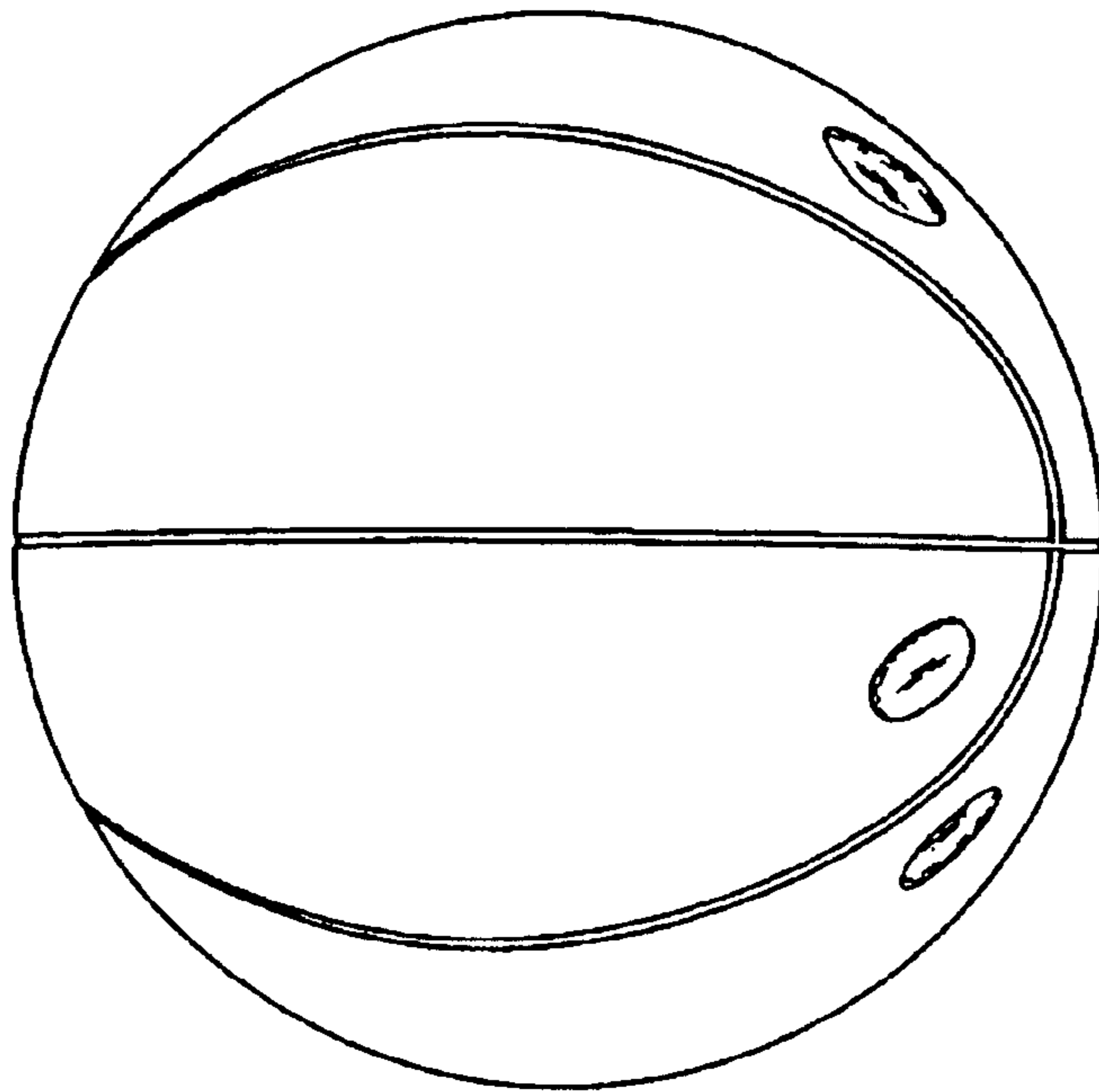

FIG. 13

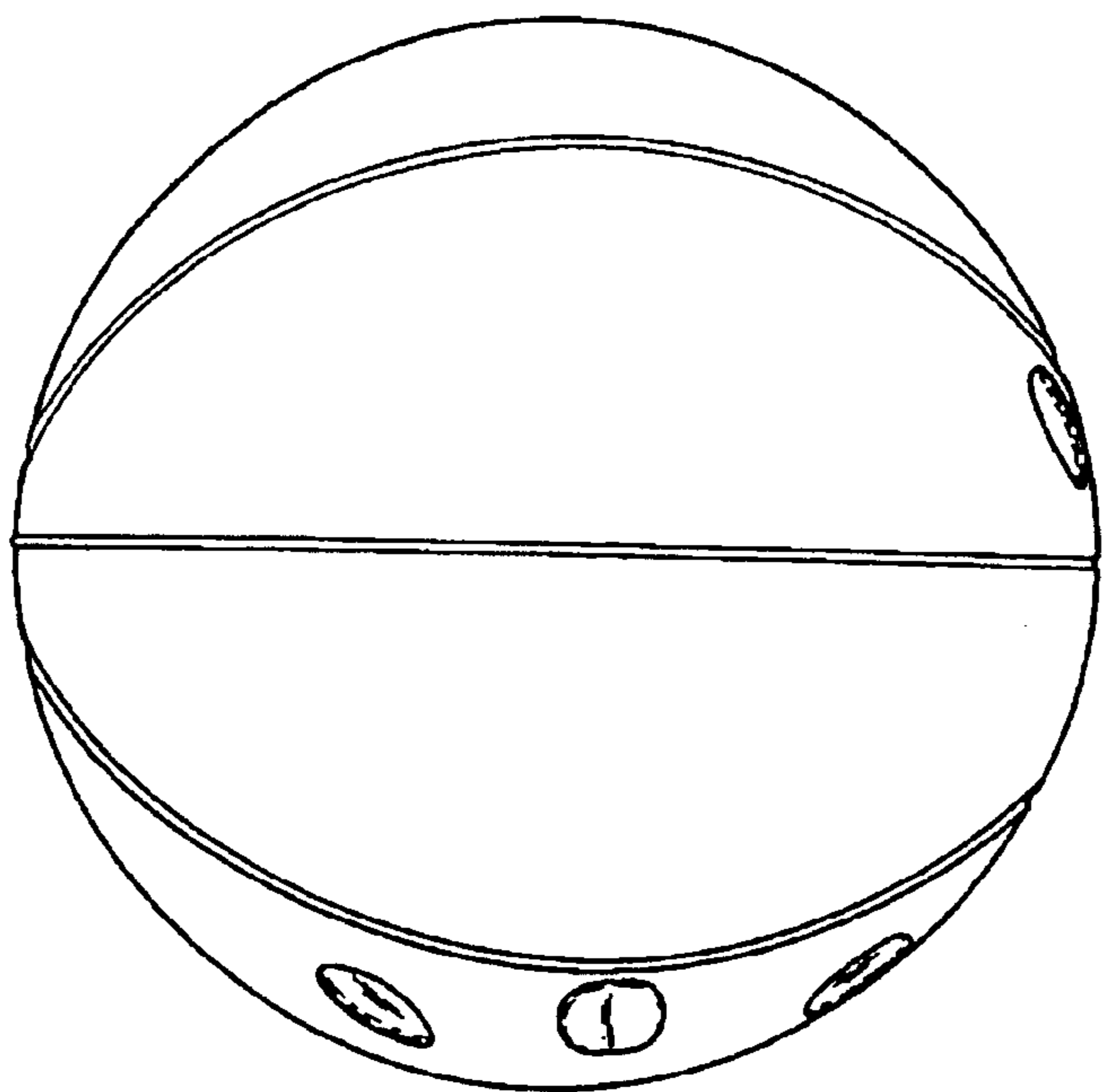

FIG. 14

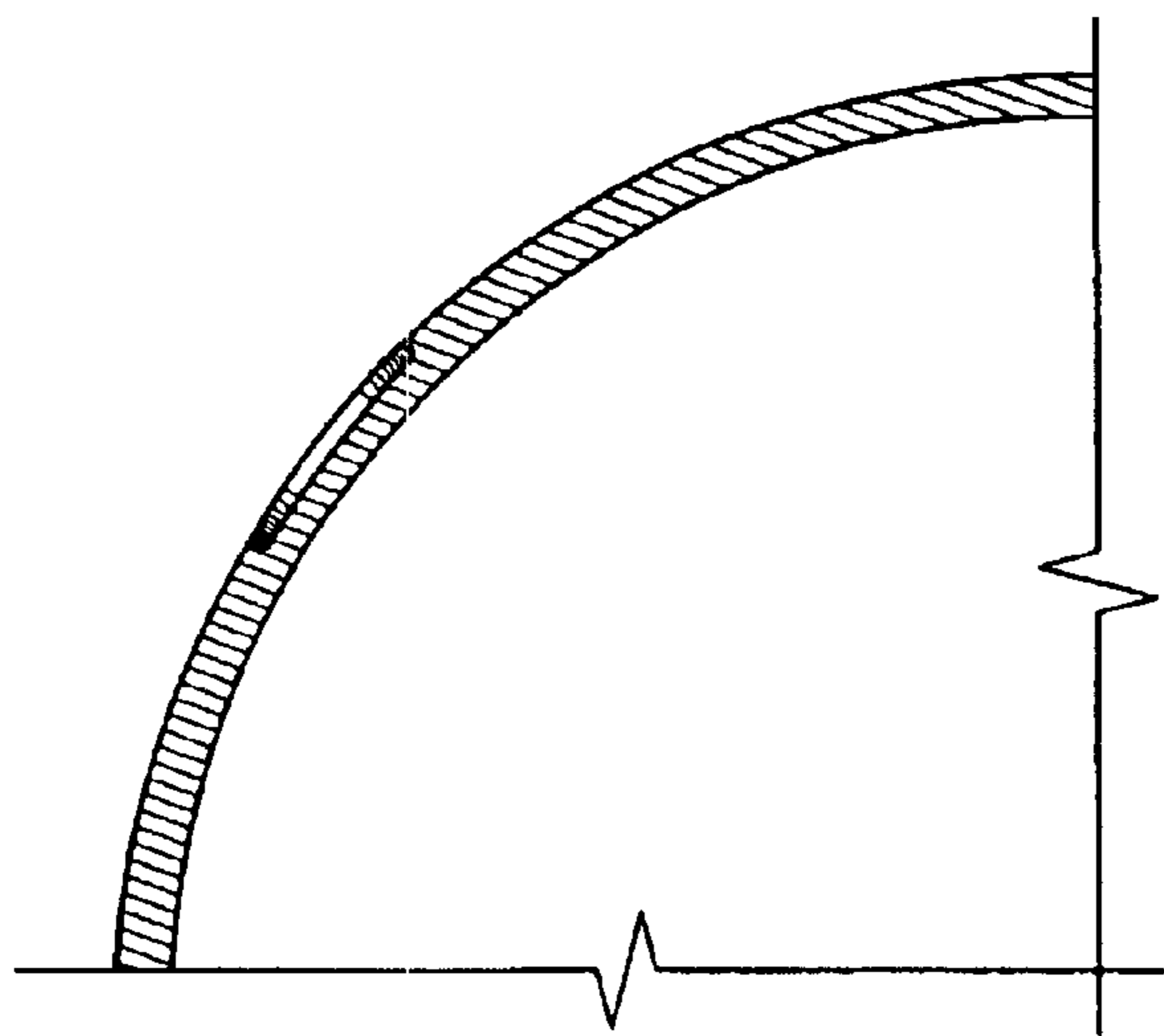

FIG. 15

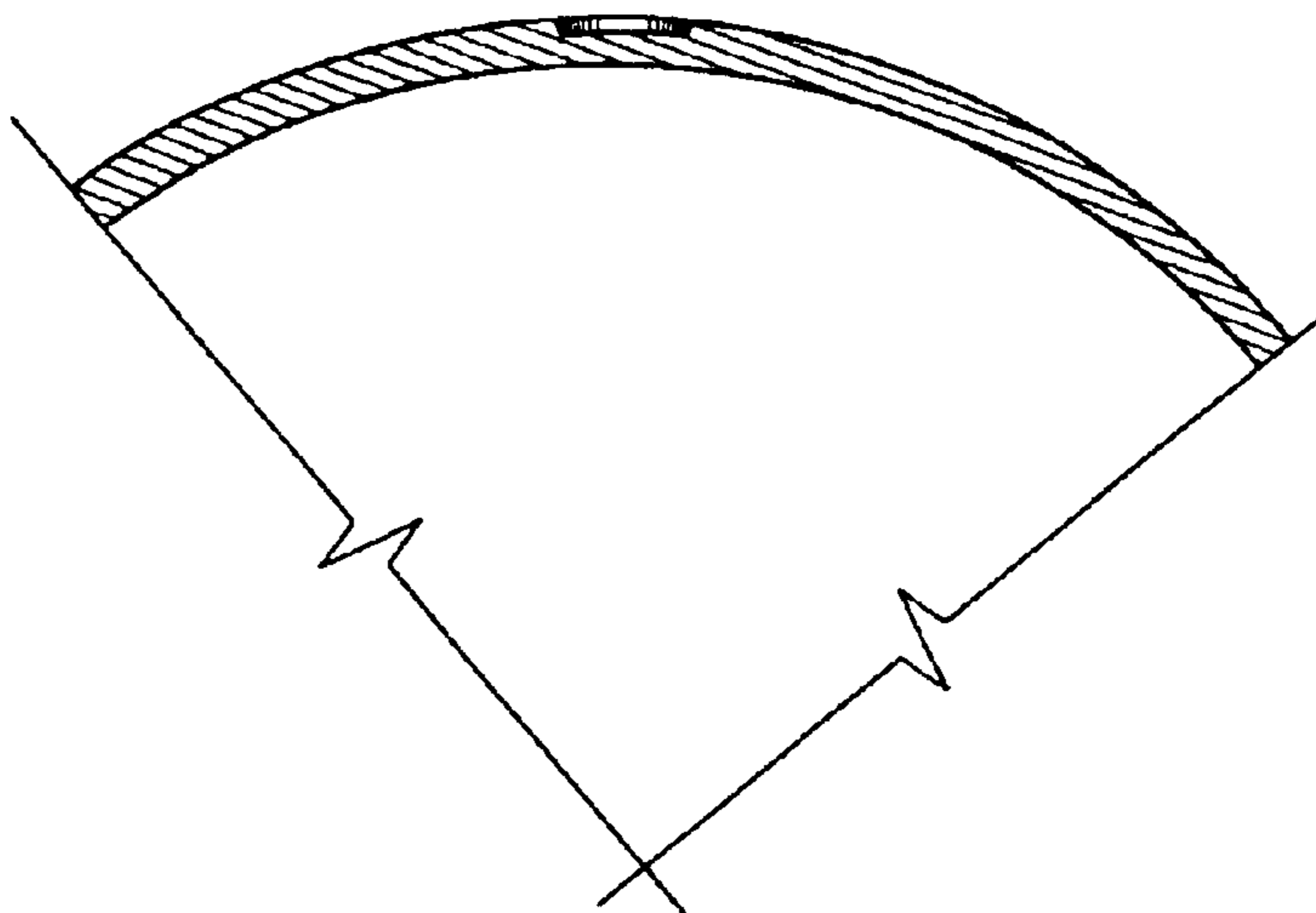

FIG. 16