



US00D551719S

(12) **United States Design Patent** (10) **Patent No.:** **US D551,719 S**
Peoples, II (45) **Date of Patent:** **** Sep. 25, 2007**

(54) **BLACK HISTORY BOARD GAME**
(76) Inventor: **Calvin Peoples, II**, 1618 Hudson
Graham La., Charlotte, NC (US) 28216

D386,542 S * 11/1997 Tobias et al. D21/351
D414,524 S * 9/1999 El-Kardah D21/351
6,102,398 A 8/2000 Kolleth
D458,645 S * 6/2002 Aldridge D21/351
6,441,400 B1 8/2002 Miyaki et al.
6,641,400 B1 * 11/2003 Kennedy 434/128

(**) Term: **14 Years**

* cited by examiner

(21) Appl. No.: **29/262,621**

Primary Examiner—Sandra L. Morris

(22) Filed: **Jul. 7, 2006**

(74) Attorney, Agent, or Firm—Lawrence J Gibney, Jr

(51) **LOC (8) Cl.** **21-01**

(57) **CLAIM**

(52) **U.S. Cl.** **D21/347; D21/351**

(58) **Field of Classification Search** D21/334–369;
273/236–288; 434/128–129, 154

The ornamental design for black history board game, as shown and described.

See application file for complete search history.

DESCRIPTION

(56) **References Cited**

U.S. PATENT DOCUMENTS

1,329,812	A	*	2/1920	Stoll	273/254
D163,068	S		4/1951	Robins		
3,114,551	A	*	12/1963	Ovitz	273/252
4,629,195	A		12/1986	Charney		
4,887,818	A	*	12/1989	Escott	273/254
4,928,967	A		5/1990	Woodliff		
5,085,439	A		2/1992	Lott		
5,292,133	A	*	3/1994	Alexander	273/256
5,322,294	A		6/1994	Landfield		
5,454,569	A		10/1995	Walker		

FIG. 1 is a front elevational view of a black history board game with playing pieces showing my new design;
FIG. 2 is a back elevational view thereof;
FIG. 3 is a right side elevational view thereof;
FIG. 4 is a left side elevational view thereof;
FIG. 5 is a top elevational view thereof;
FIG. 6 is a bottom elevational view thereof; and,
FIG. 7 is an isometric view of the device.

1 Claim, 5 Drawing Sheets

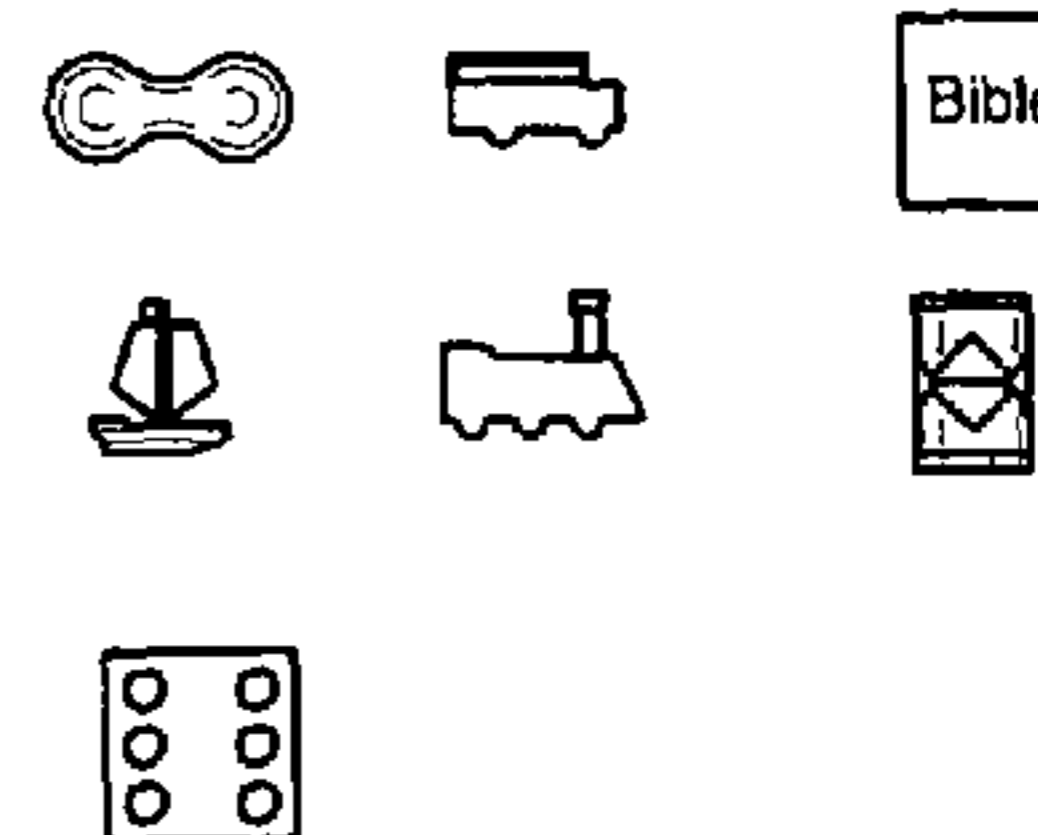
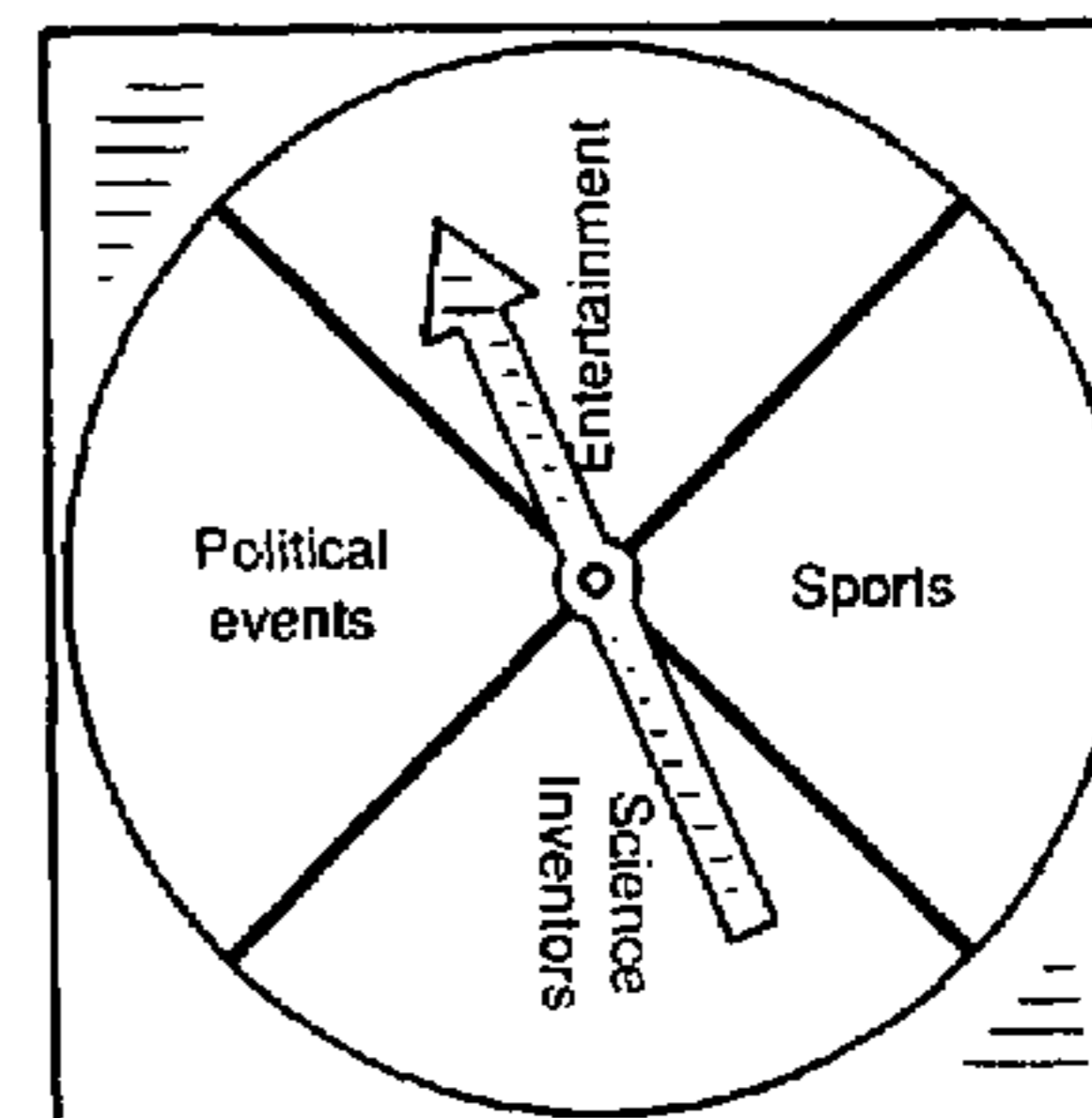
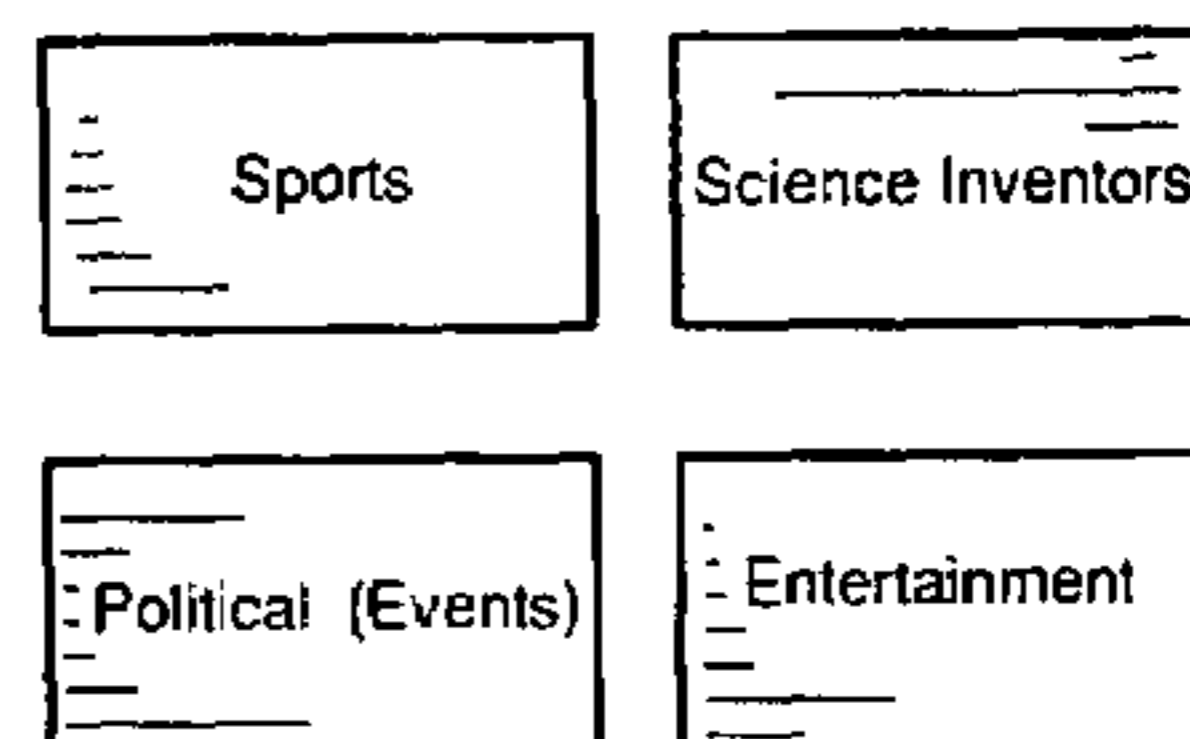
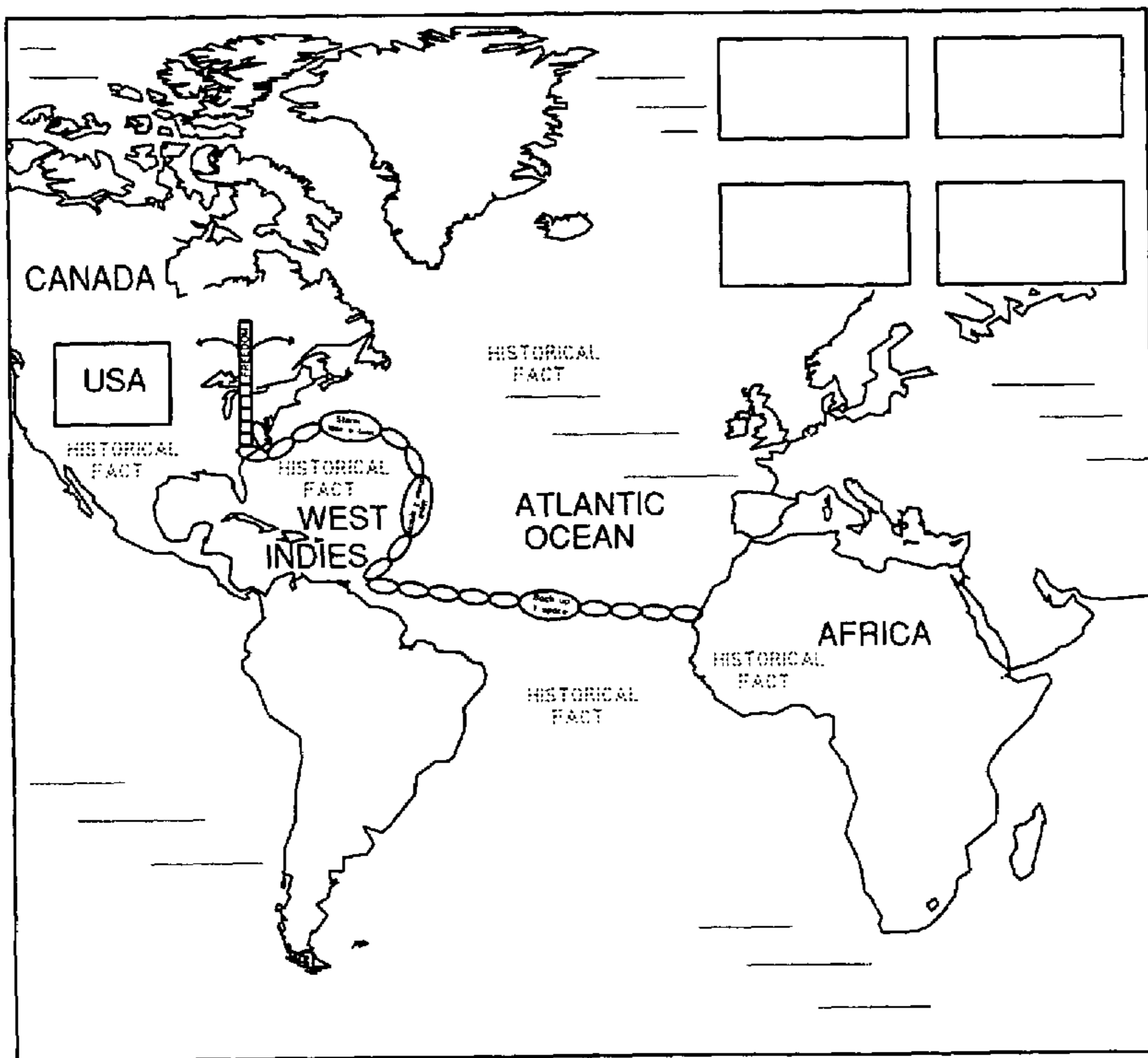

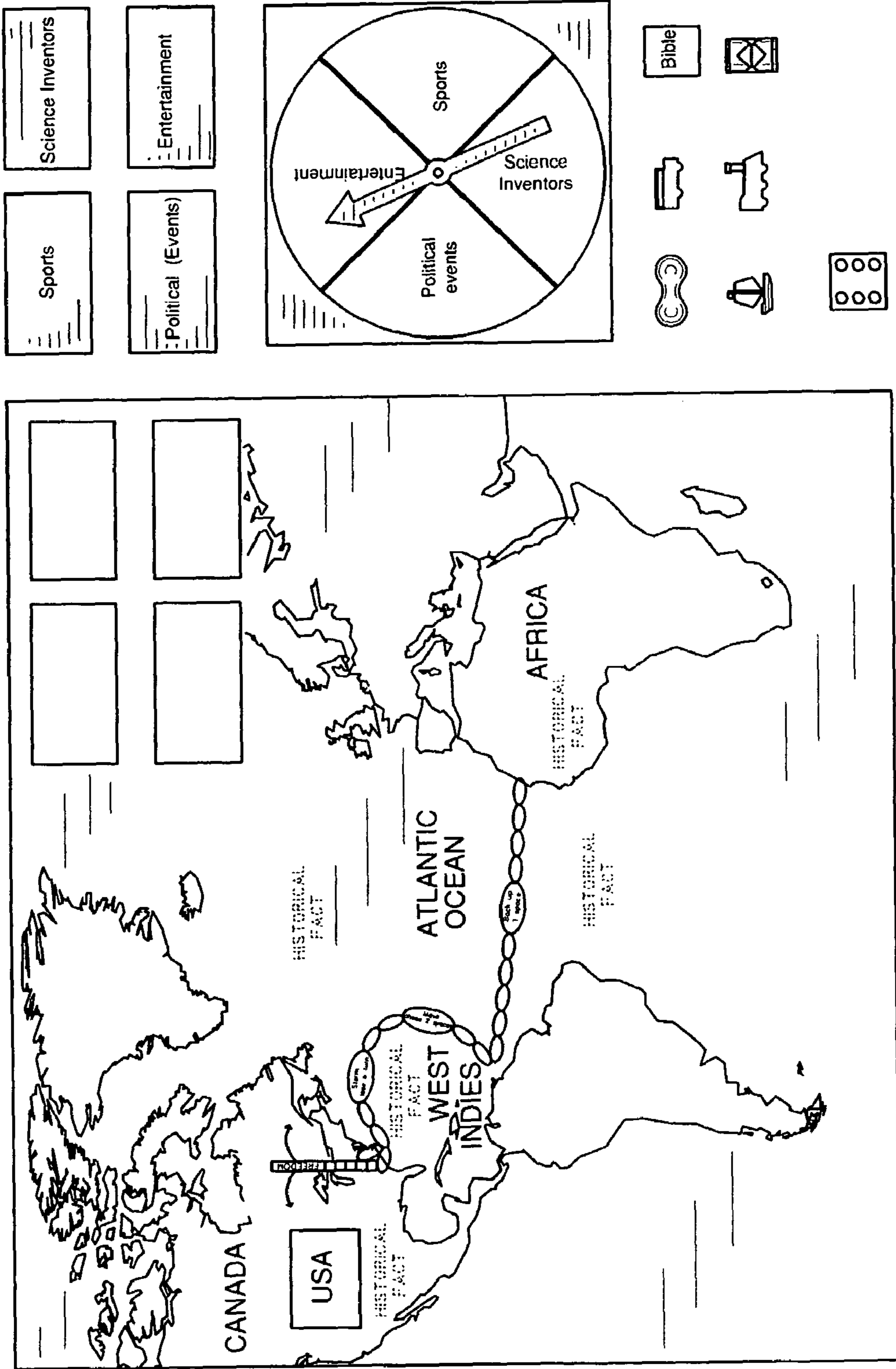

FIG. 1

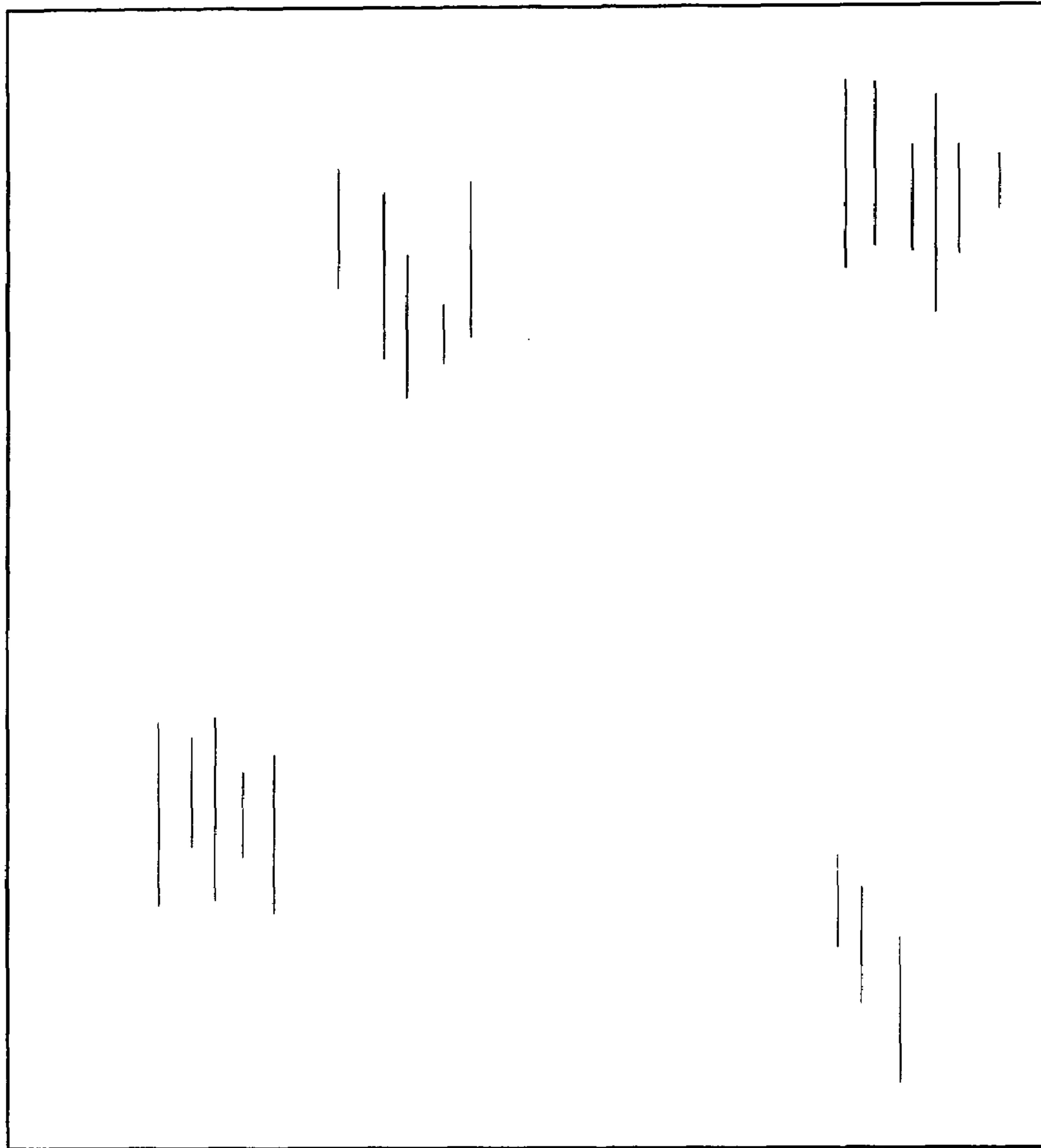

FIG. 2

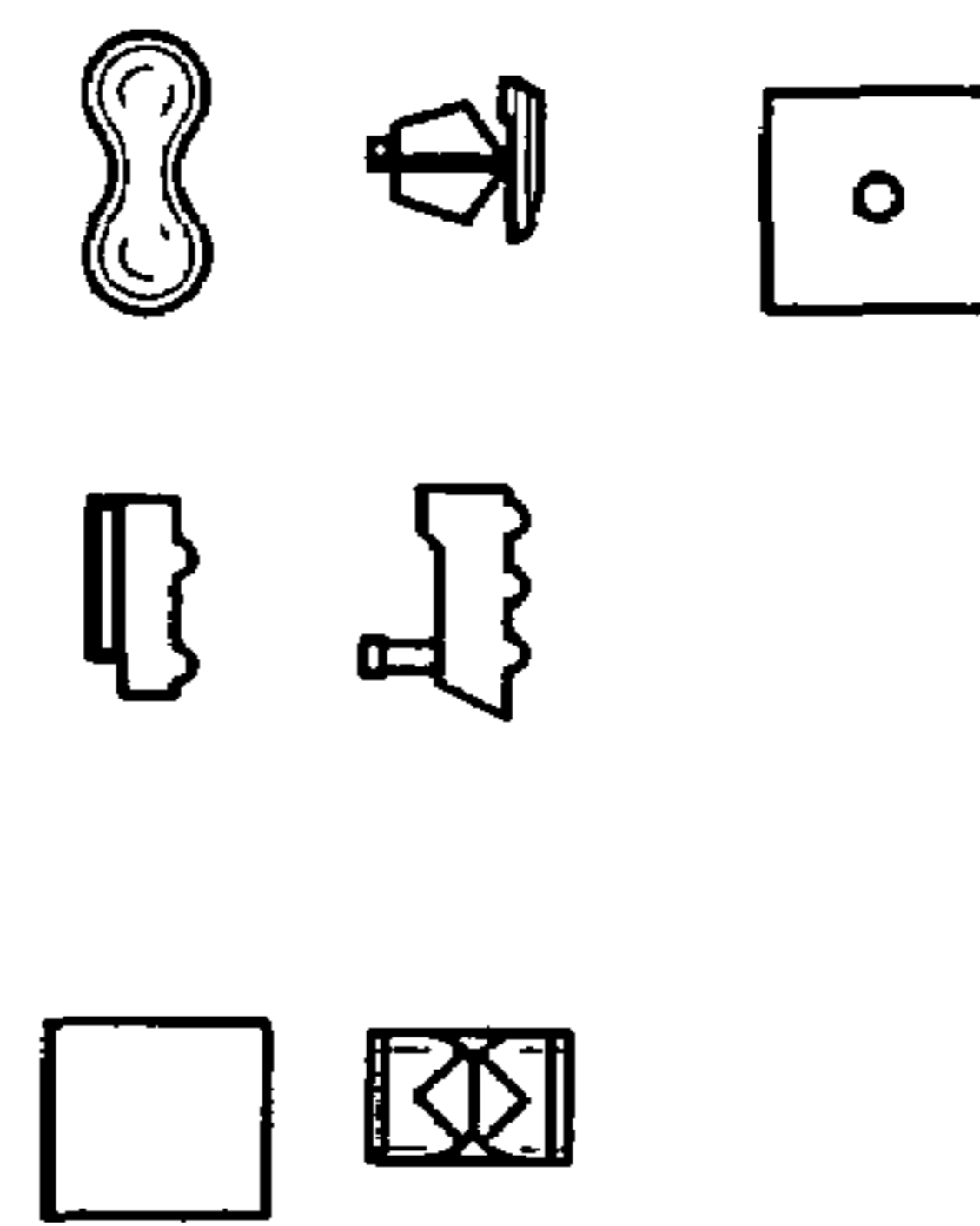
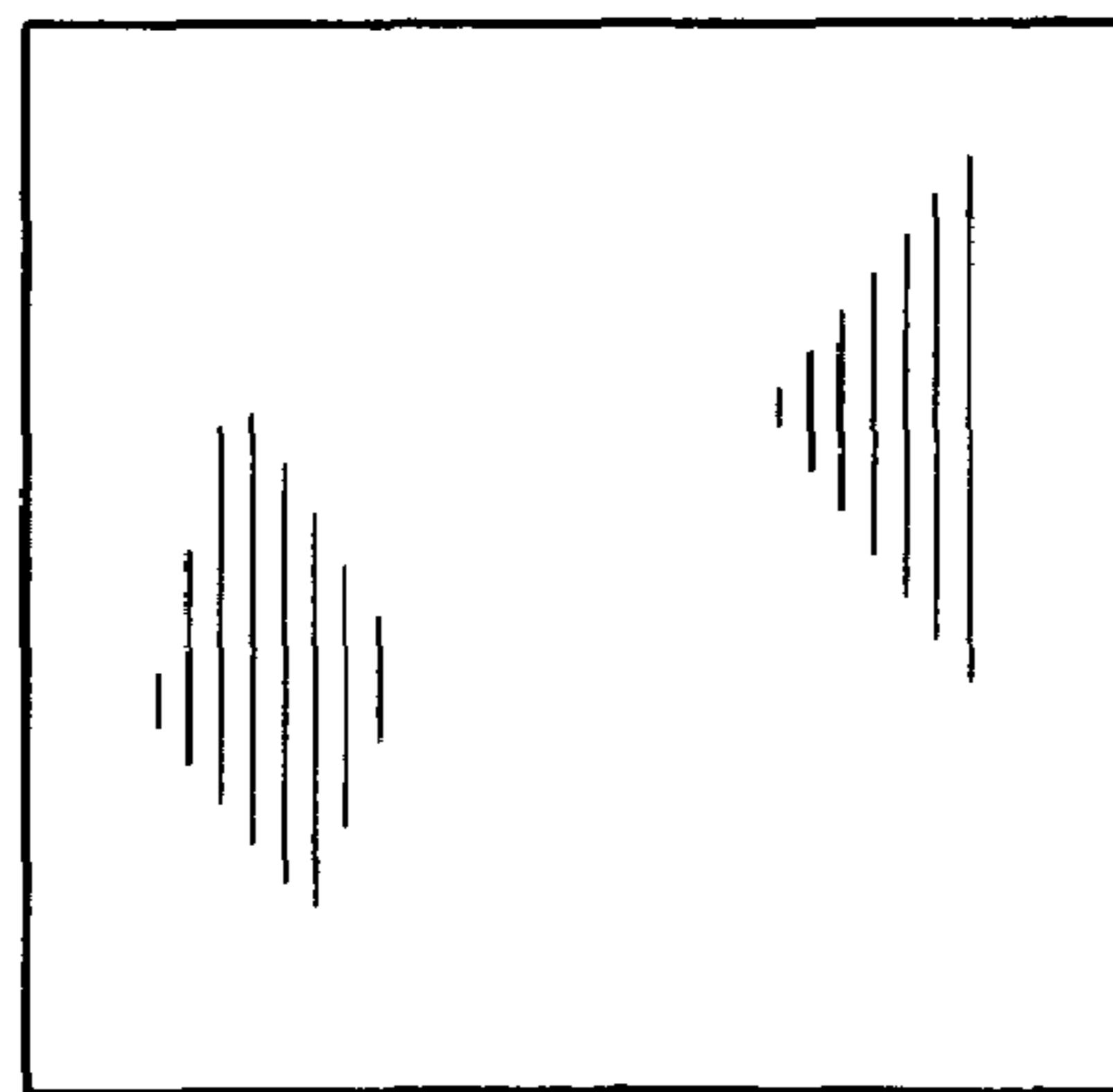
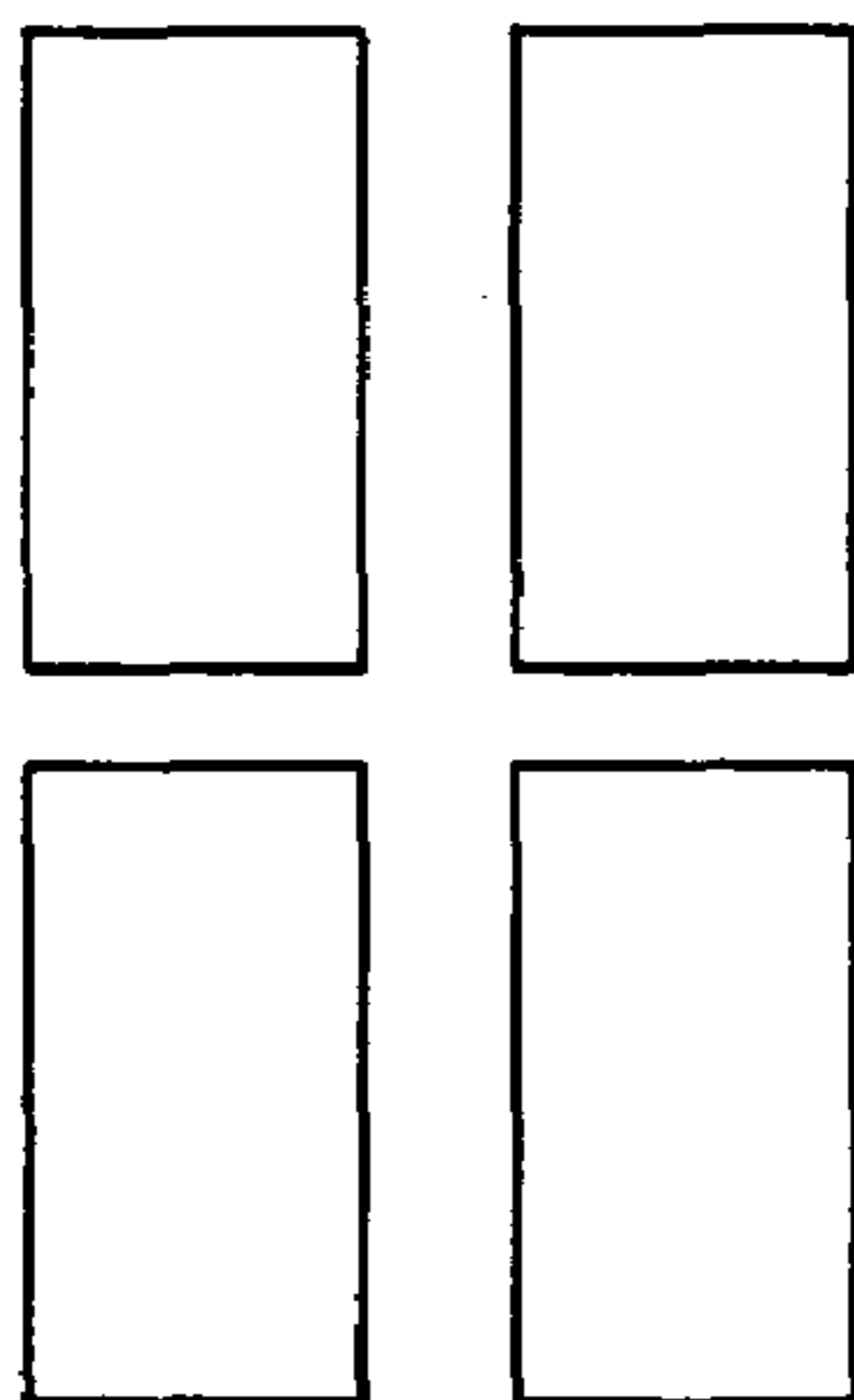

FIG. 3

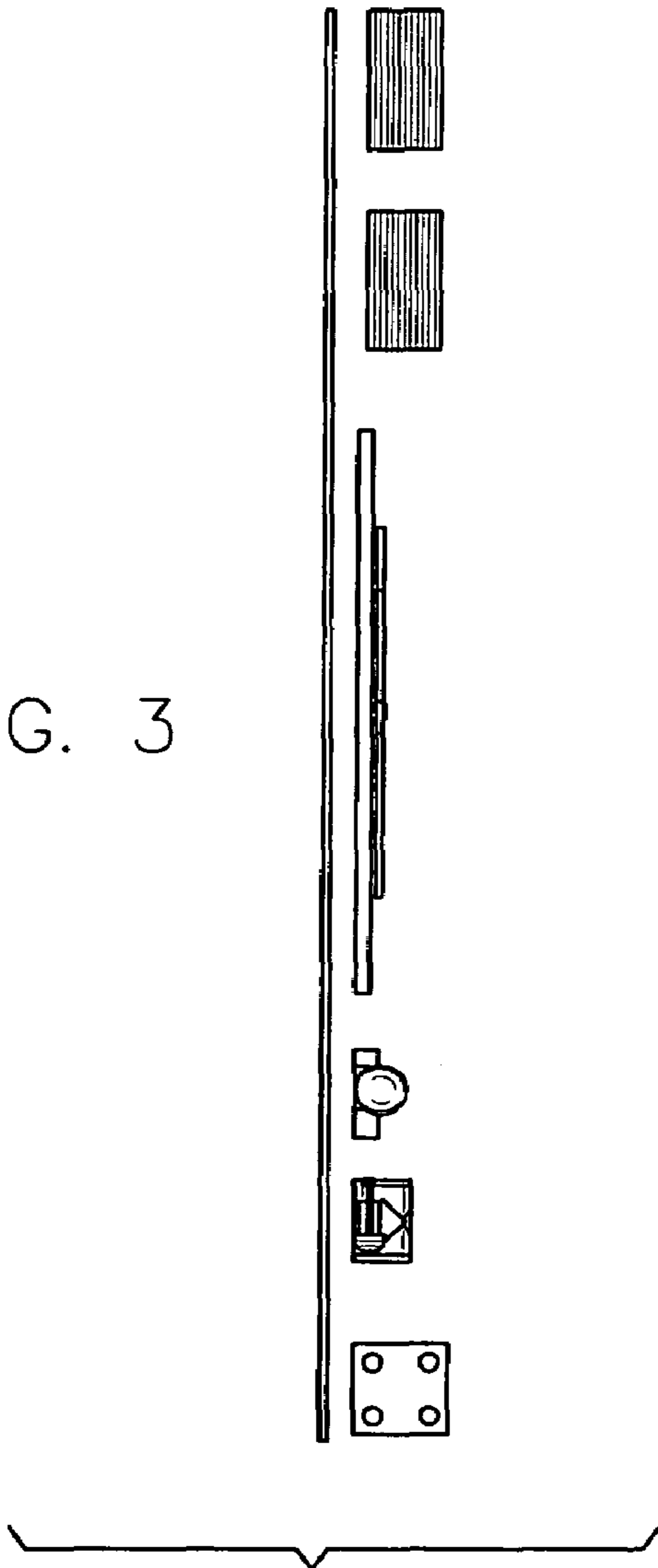
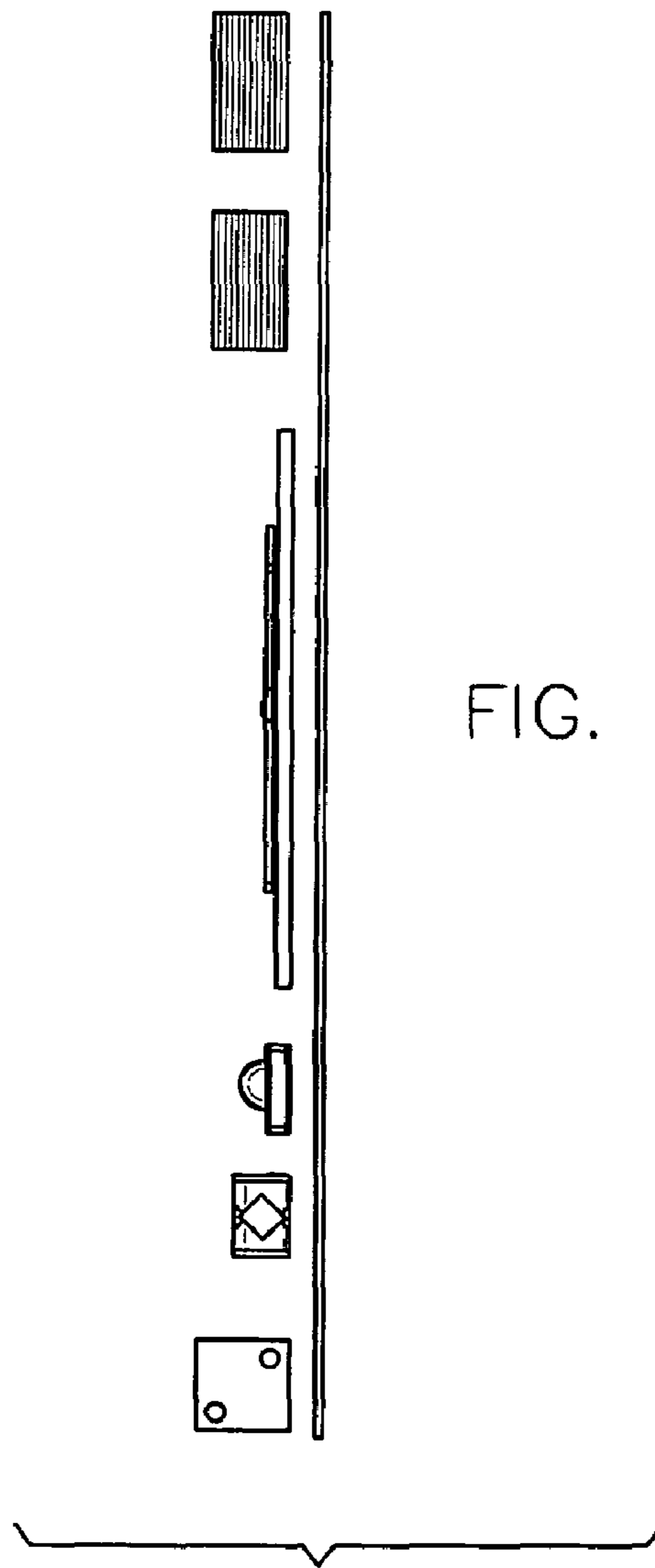

FIG. 4



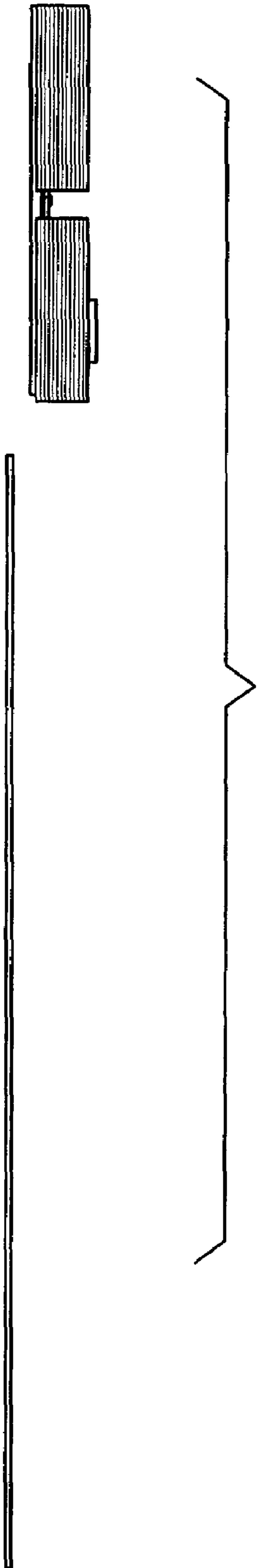

FIG. 5

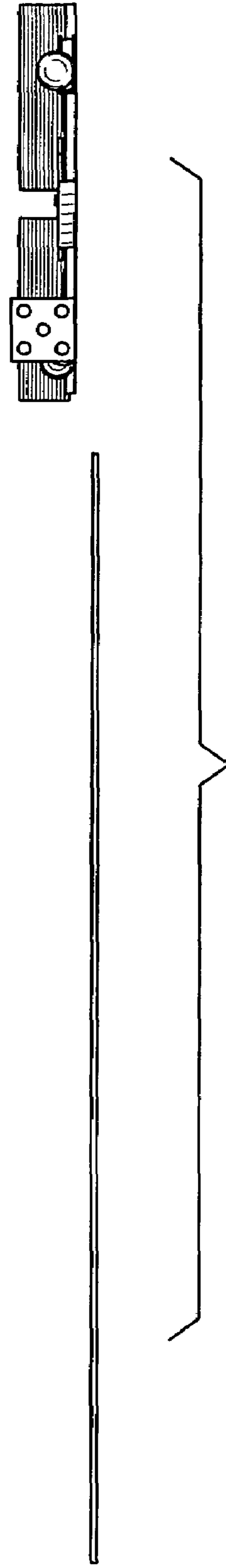

FIG. 6

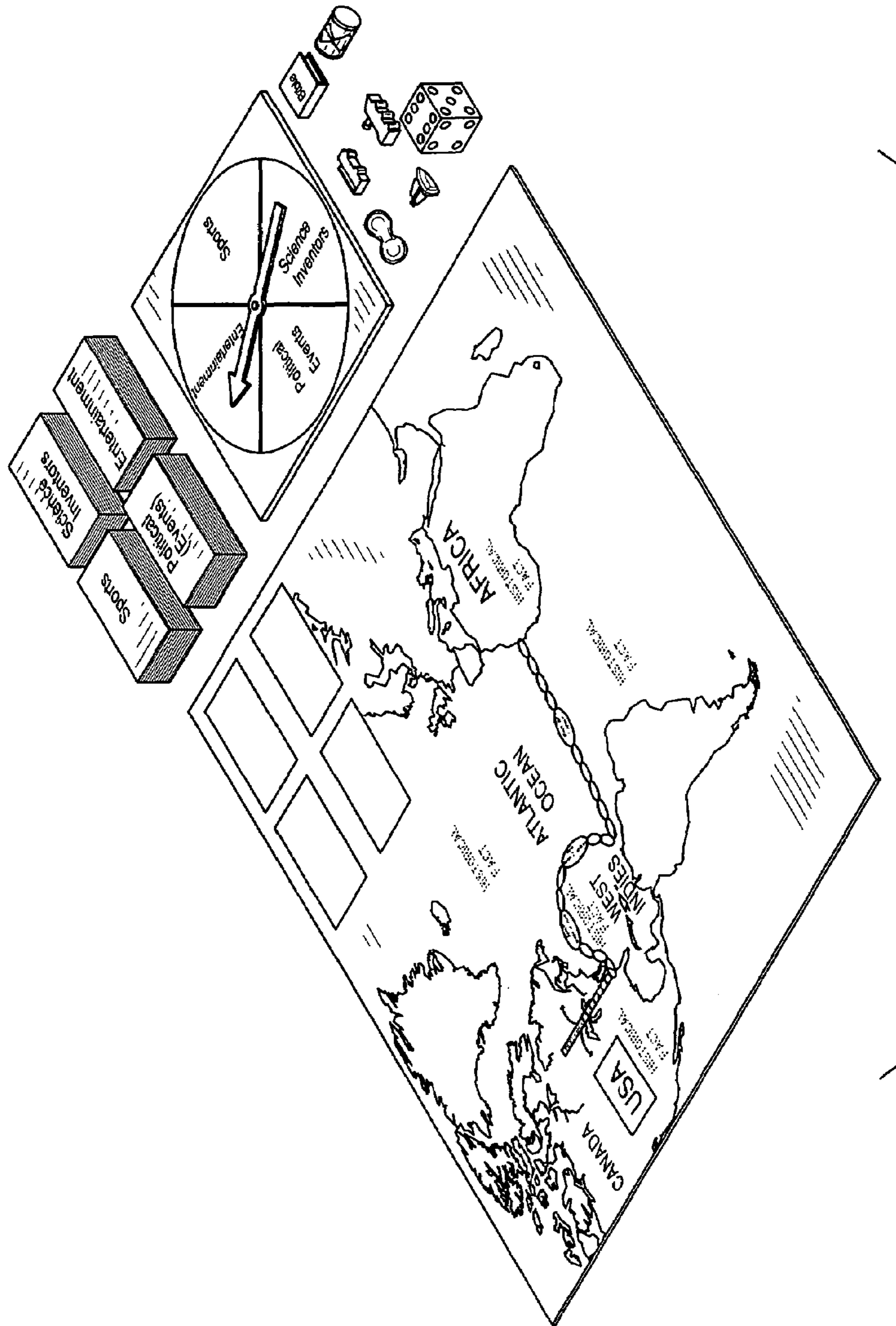

FIG. 7