



US00D551671S

(12) **United States Design Patent**  
**Deng**

(10) **Patent No.:** **US D551,671 S**

(45) **Date of Patent:** **\*\* Sep. 25, 2007**

(54) **FRONT BEZEL FOR COMPUTER ENCLOSURE**

(75) Inventor: **Shu Deng**, Shenzhen (CN)

(73) Assignee: **Hon Hai Precision Industry Co., Ltd.**,  
Tu-Cheng, Taipei Hsien (TW)

(\*\*) Term: **14 Years**

(21) Appl. No.: **29/258,057**

(22) Filed: **Apr. 14, 2006**

(30) **Foreign Application Priority Data**

Jan. 21, 2006 (CN) ..... 2006 3 0051351

(51) **LOC (8) Cl.** ..... **14-02**

(52) **U.S. Cl.** ..... **D14/444**

(58) **Field of Classification Search** ..... D14/441-446;  
D13/162, 184, 199; 312/223.2; 361/680-686,  
361/690-696; 369/34.01, 36.01

See application file for complete search history.

(56) **References Cited**

**U.S. PATENT DOCUMENTS**

5,169,218 A \* 12/1992 Chu ..... 312/223.2  
D431,825 S \* 10/2000 Jean et al. .... D14/444

D439,254 S \* 3/2001 Zhao ..... D14/441

\* cited by examiner

*Primary Examiner*—Freda S. Nunn

(74) *Attorney, Agent, or Firm*—Wei Te Chung

(57) **CLAIM**

The ornamental design for a front bezel for a computer enclosure, as shown and described.

**DESCRIPTION**

FIG. 1 is a perspective view of a front bezel for a computer enclosure showing my new design;

FIG. 2 is a front elevational view thereof;

FIG. 3 is a rear elevational view thereof;

FIG. 4 is a left side elevational view thereof;

FIG. 5 is a right side elevational view thereof;

FIG. 6 is a top plan view thereof;

FIG. 7 is a bottom plan view thereof; and,

FIG. 8 is a perspective view thereof being mounted to a computer enclosure.

Broken lines are for illustrative purposes only and form no part of the claimed design.

**1 Claim, 6 Drawing Sheets**

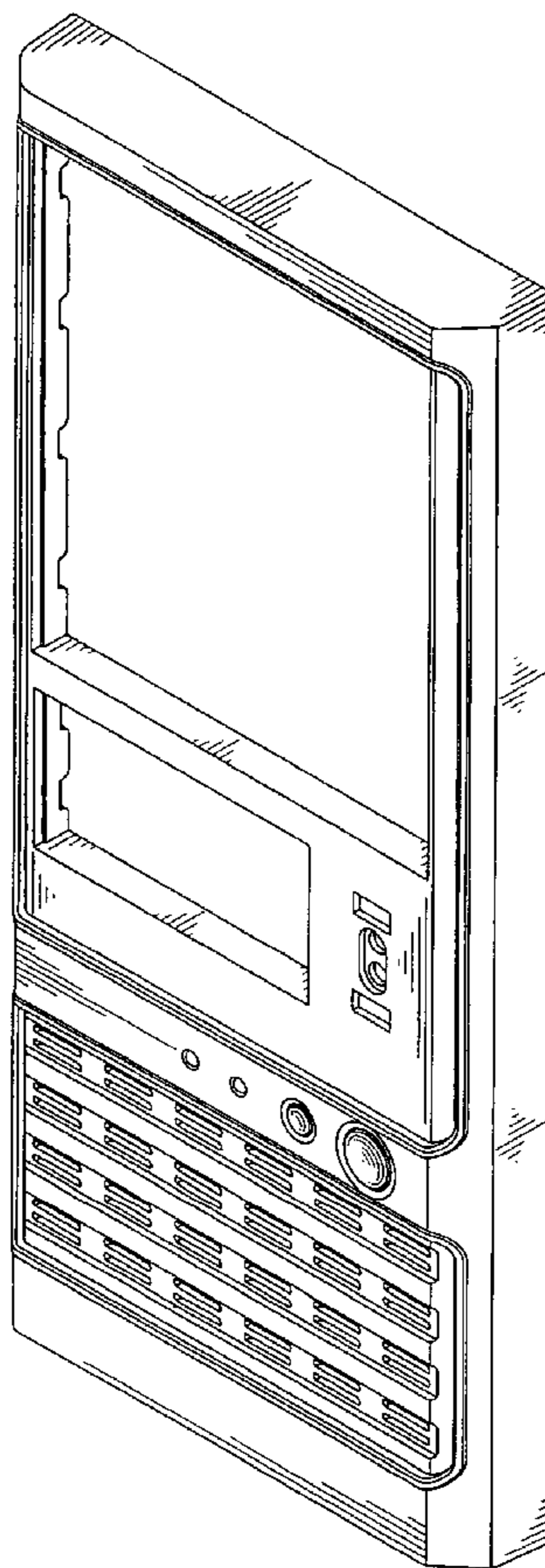

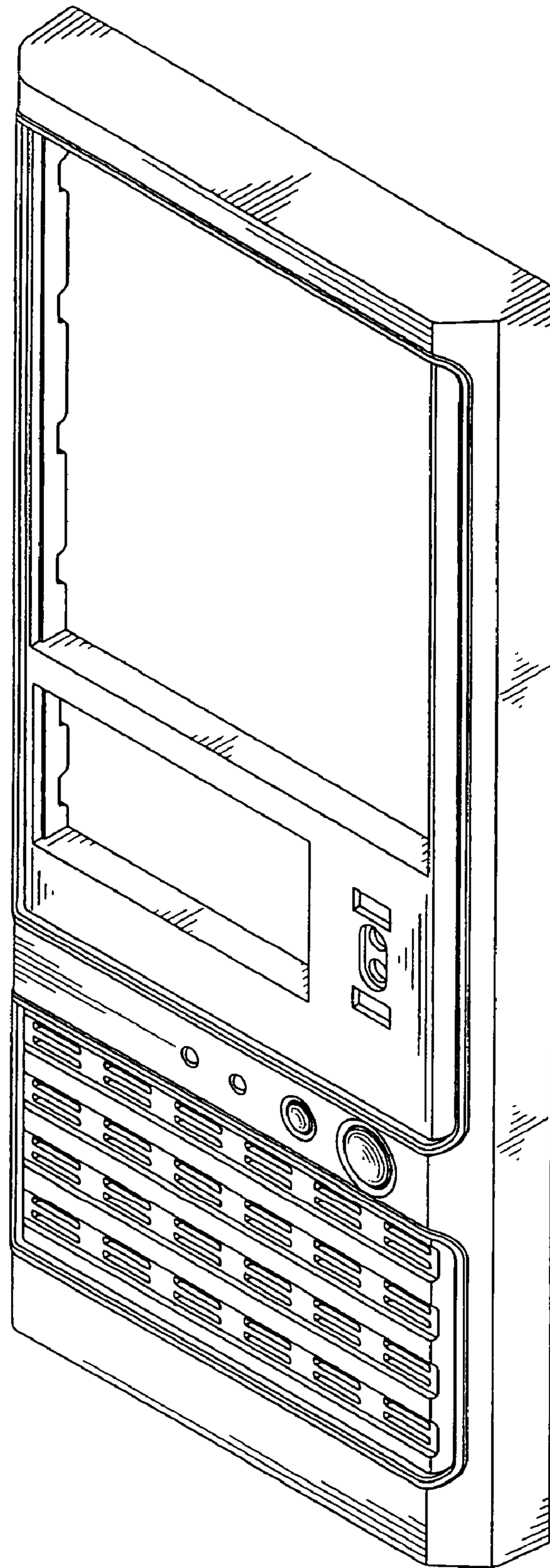

FIG. 1

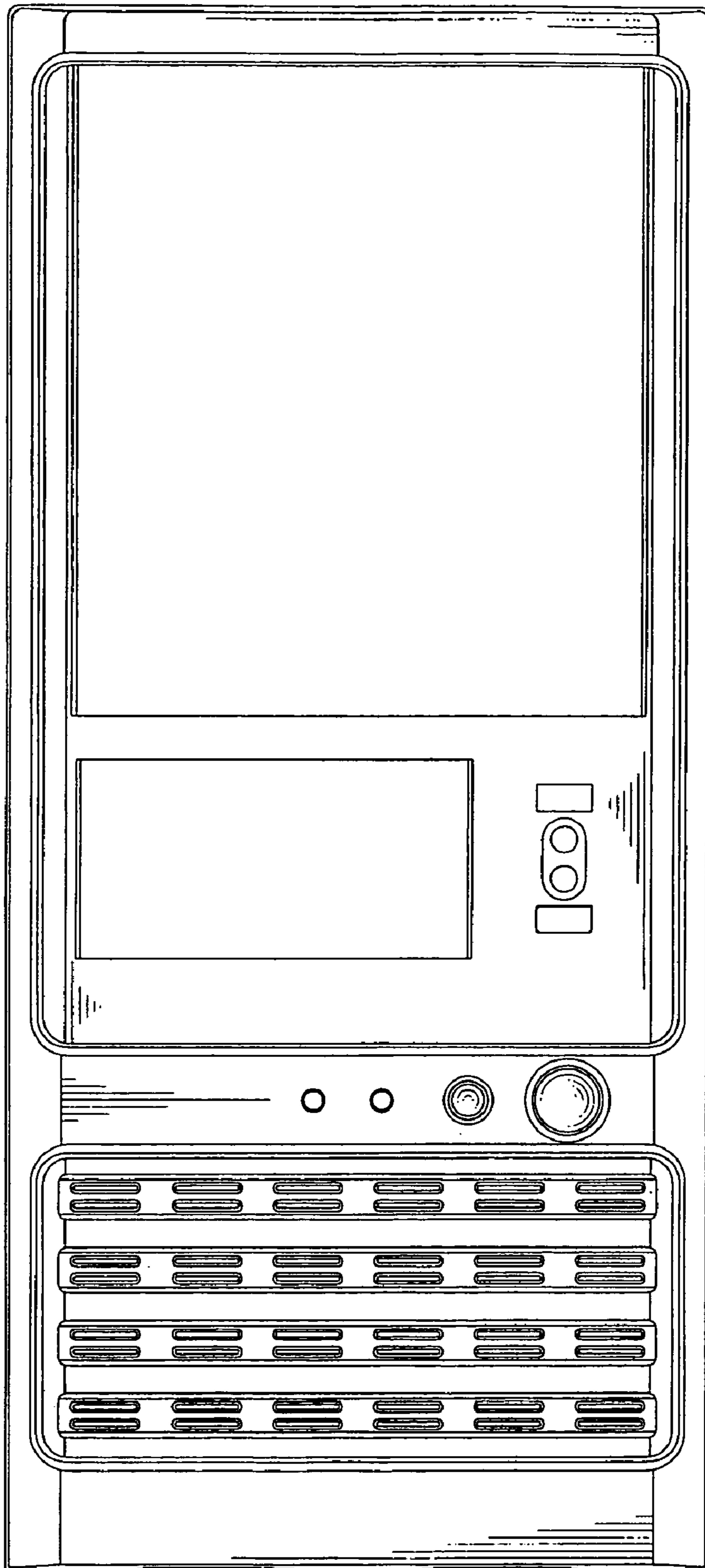

FIG. 2

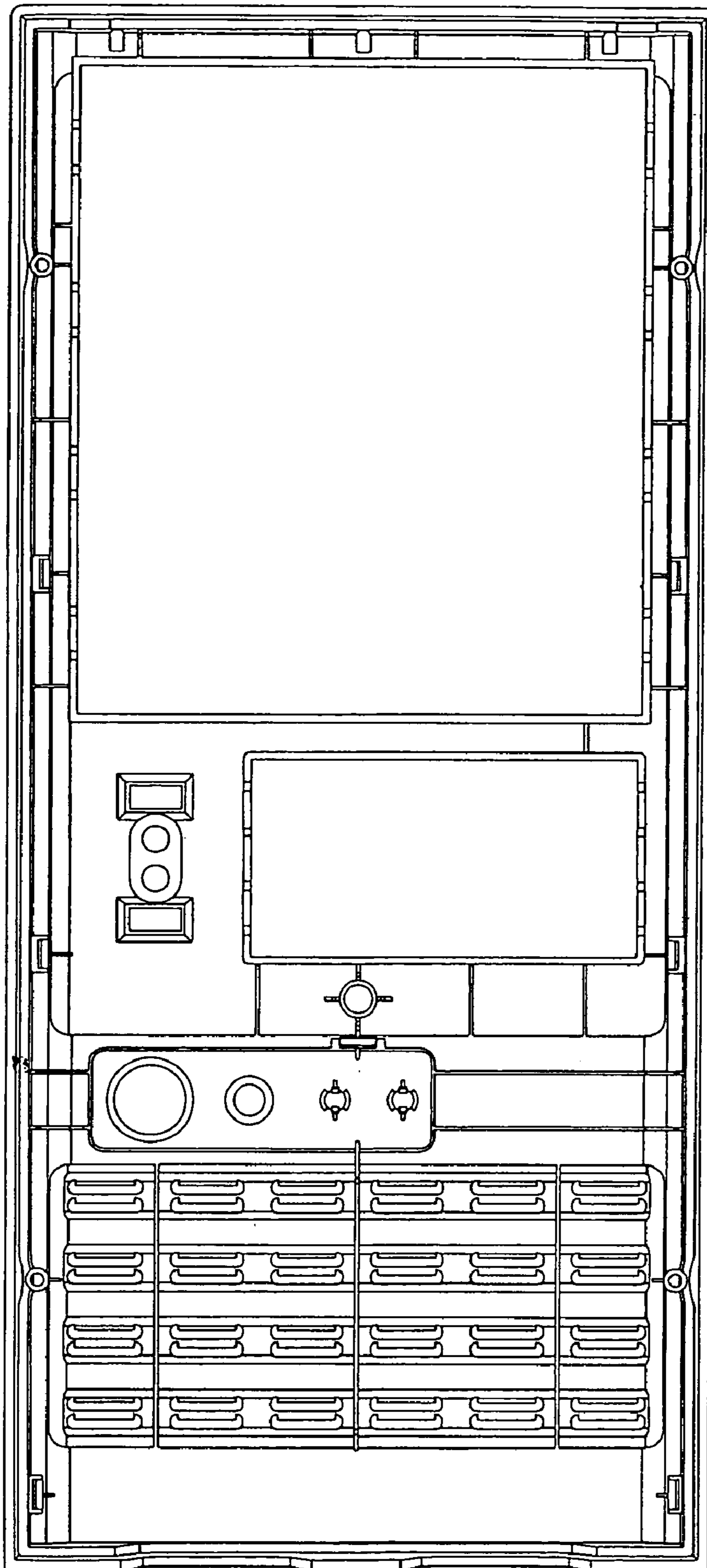

FIG. 3

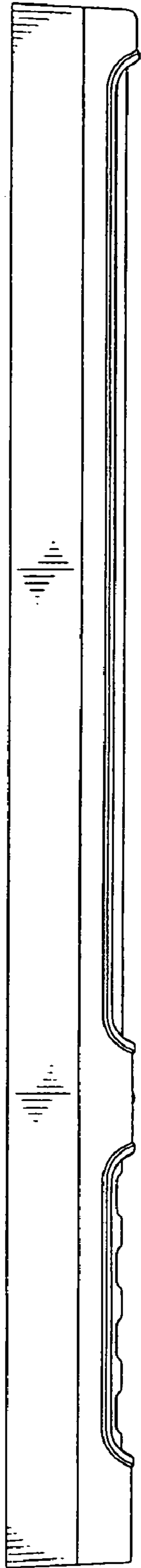

FIG. 4

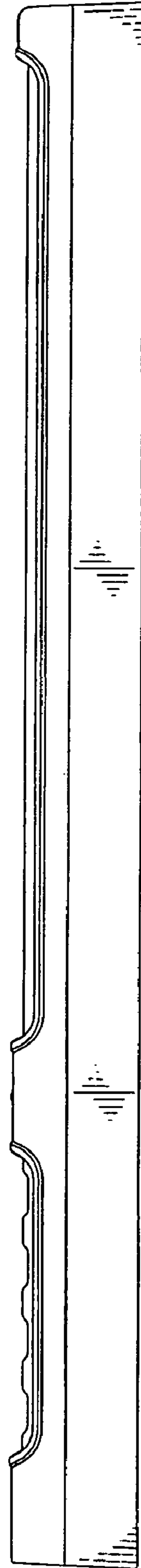

FIG. 5

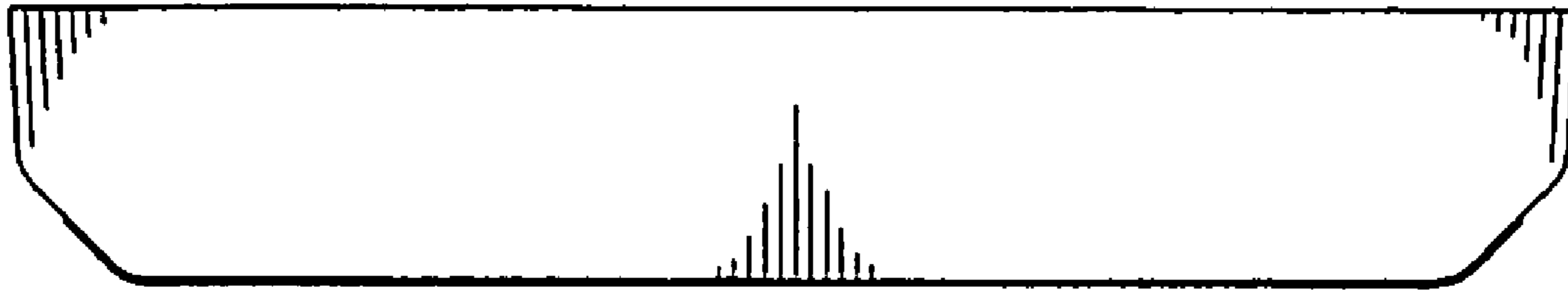

FIG. 6

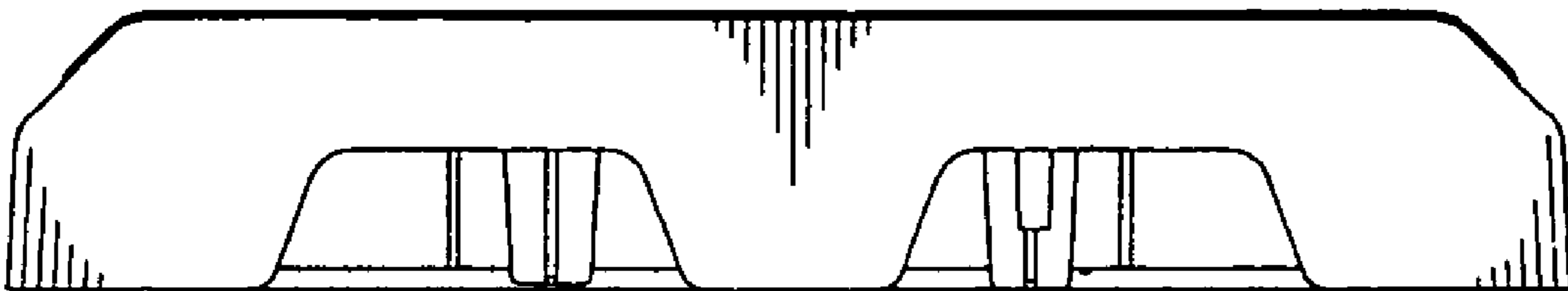

FIG. 7

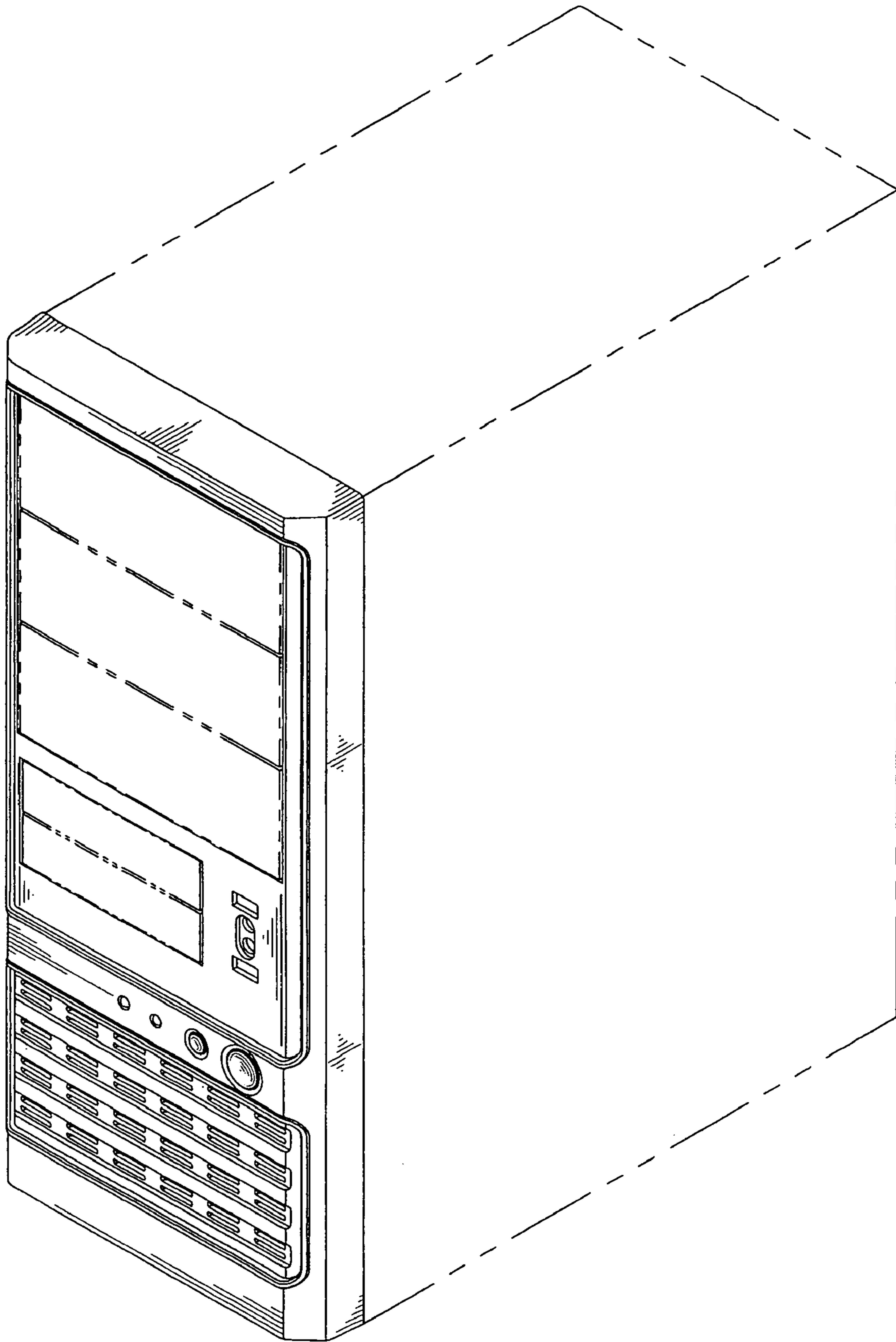

FIG. 8