

US00D551618S

(12) **United States Design Patent** (10) **Patent No.:** **US D551,618 S**
Aglassinger (45) **Date of Patent:** **** Sep. 25, 2007**

(54) **BATTERY CHARGER FOR A CORDLESS SCREWDRIVER**

(75) Inventor: **Hans-Peter Aglassinger**, Esslingen (DE)

(73) Assignee: **Robert Bosch GmbH**, Stuttgart (DE)

(**) Term: **14 Years**

(21) Appl. No.: **29/261,596**

(22) Filed: **Jun. 16, 2006**

(30) **Foreign Application Priority Data**

Jan. 26, 2006 (EM) 000469820

(51) **LOC (8) Cl.** **13-02**

(52) **U.S. Cl.** **D13/108**

(58) **Field of Classification Search** D13/107-110, D13/118-119, 184; D14/251, 253, 432, D14/434; 320/107-115

See application file for complete search history.

(56) **References Cited**

U.S. PATENT DOCUMENTS

D313,221	S	*	12/1990	Skully et al.	D13/108
D314,173	S	*	1/1991	Soren et al.	D13/108
5,220,270	A	*	6/1993	Peickert	320/107
D360,723	S	*	7/1995	Kasai et al.	D32/73
D376,585	S	*	12/1996	Wathen et al.	D14/434
D422,965	S	*	4/2000	Laufer et al.	D13/108
D445,975	S	*	7/2001	Stratford	D32/31

D466,476	S	*	12/2002	Stratford	D13/108
D466,511	S	*	12/2002	Croley et al.	D14/434
D472,896	S	*	4/2003	Peiker	D14/253
D493,801	S	*	8/2004	Byun	D14/453
D515,029	S	*	2/2006	Hattori	D13/108
D532,744	S	*	11/2006	Aglassinger	D13/108

* cited by examiner

Primary Examiner—Alan P. Douglas

Assistant Examiner—Rosemary K. Tarcza

(74) *Attorney, Agent, or Firm*—Michael J. Striker

(57) **CLAIM**

The ornamental design for a battery charger for a cordless screwdriver, as shown and described.

DESCRIPTION

FIG. 1 is a perspective view of a battery charging terminal for a cordless screwdriver showing my new design;

FIG. 2 is a side view thereof;

FIG. 3 is a front perspective view thereof;

FIG. 4 is a top view thereof;

FIG. 5 is a rear perspective view thereof;

FIG. 6 is the opposite side view of FIG. 2 thereof; and,

FIG. 7 is a bottom view thereof.

The word Bosch appearing in broken lines is for illustrative purposes only and does not form part of the claimed design.

1 Claim, 7 Drawing Sheets

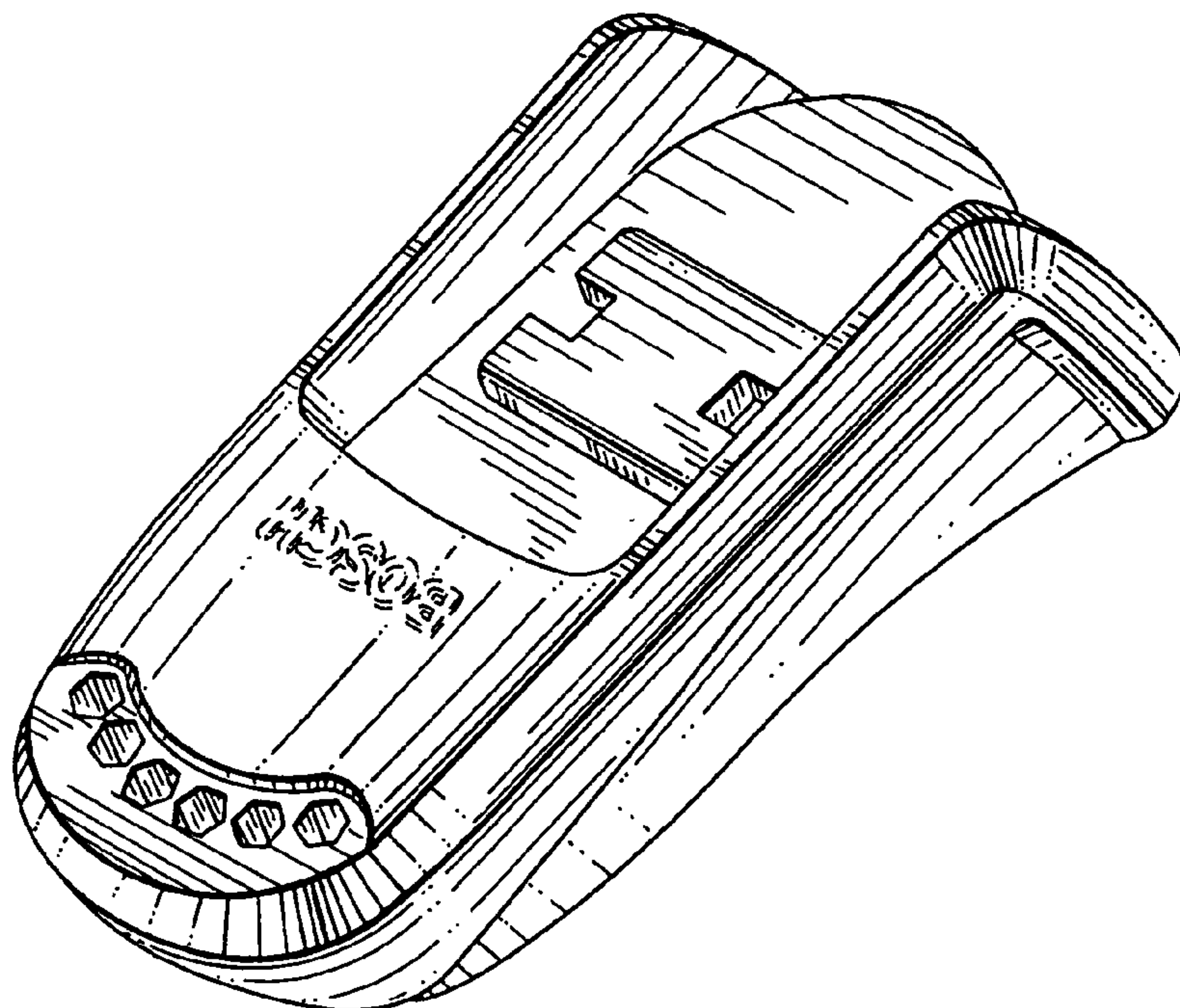

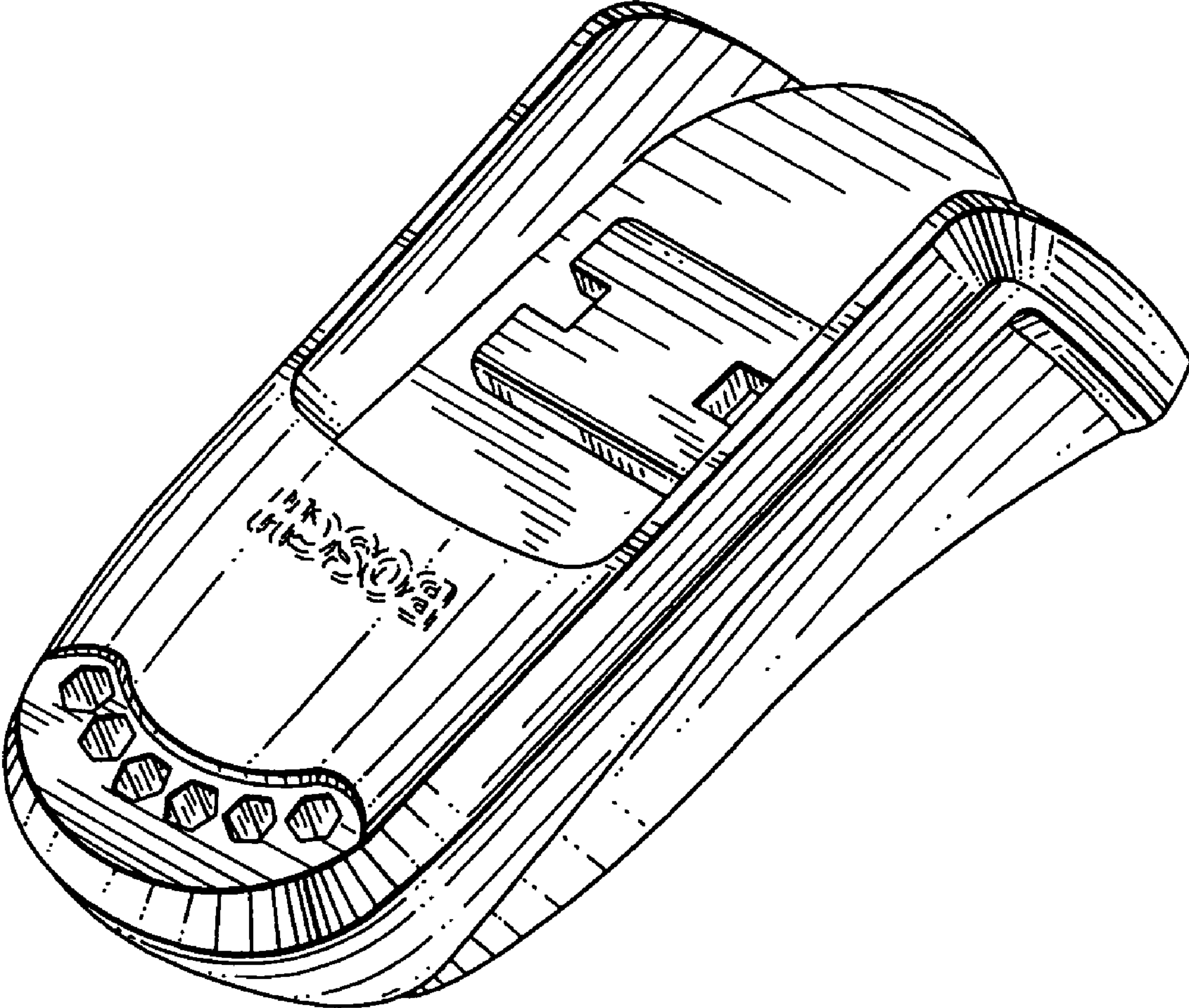

FIG. 1

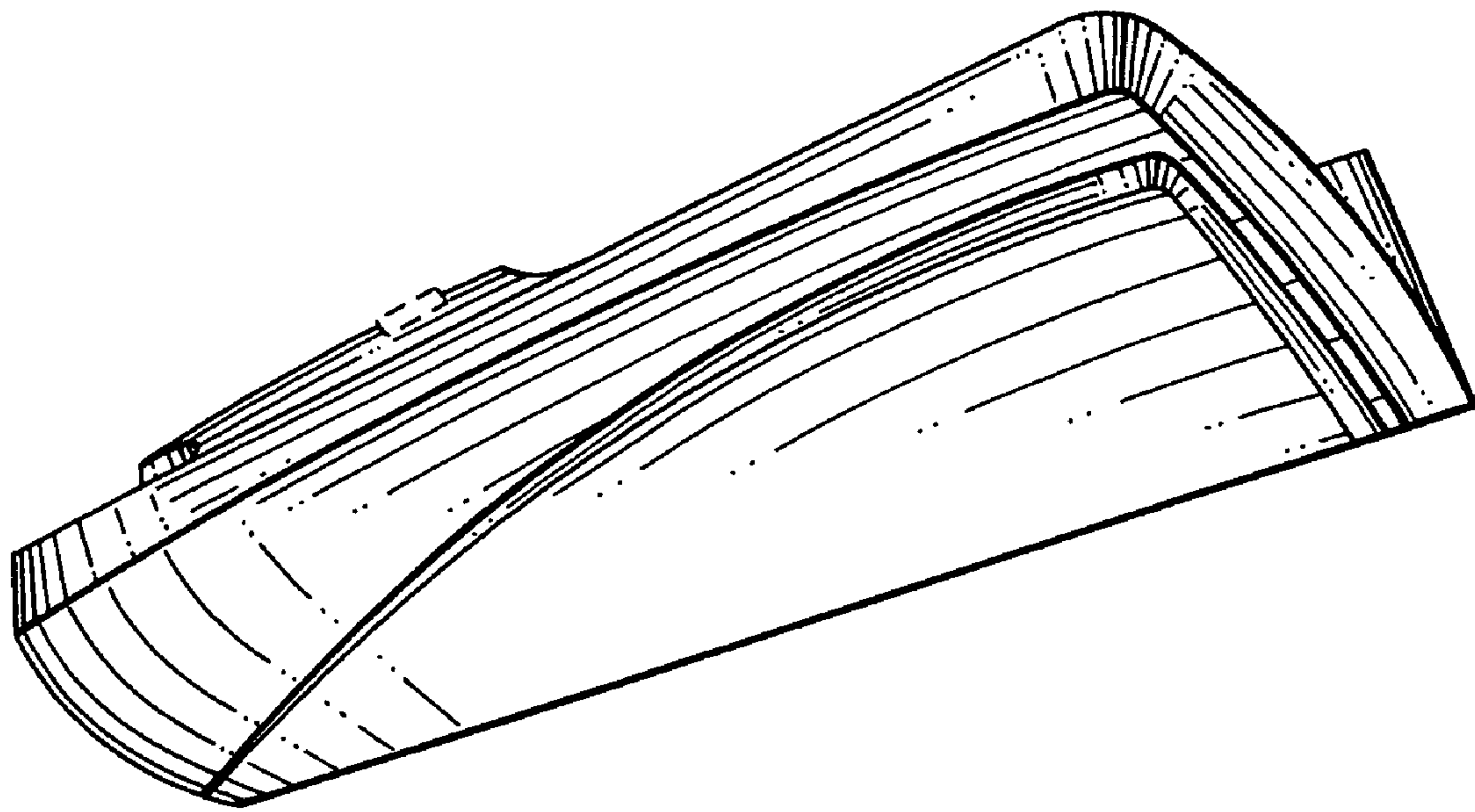

FIG. 2

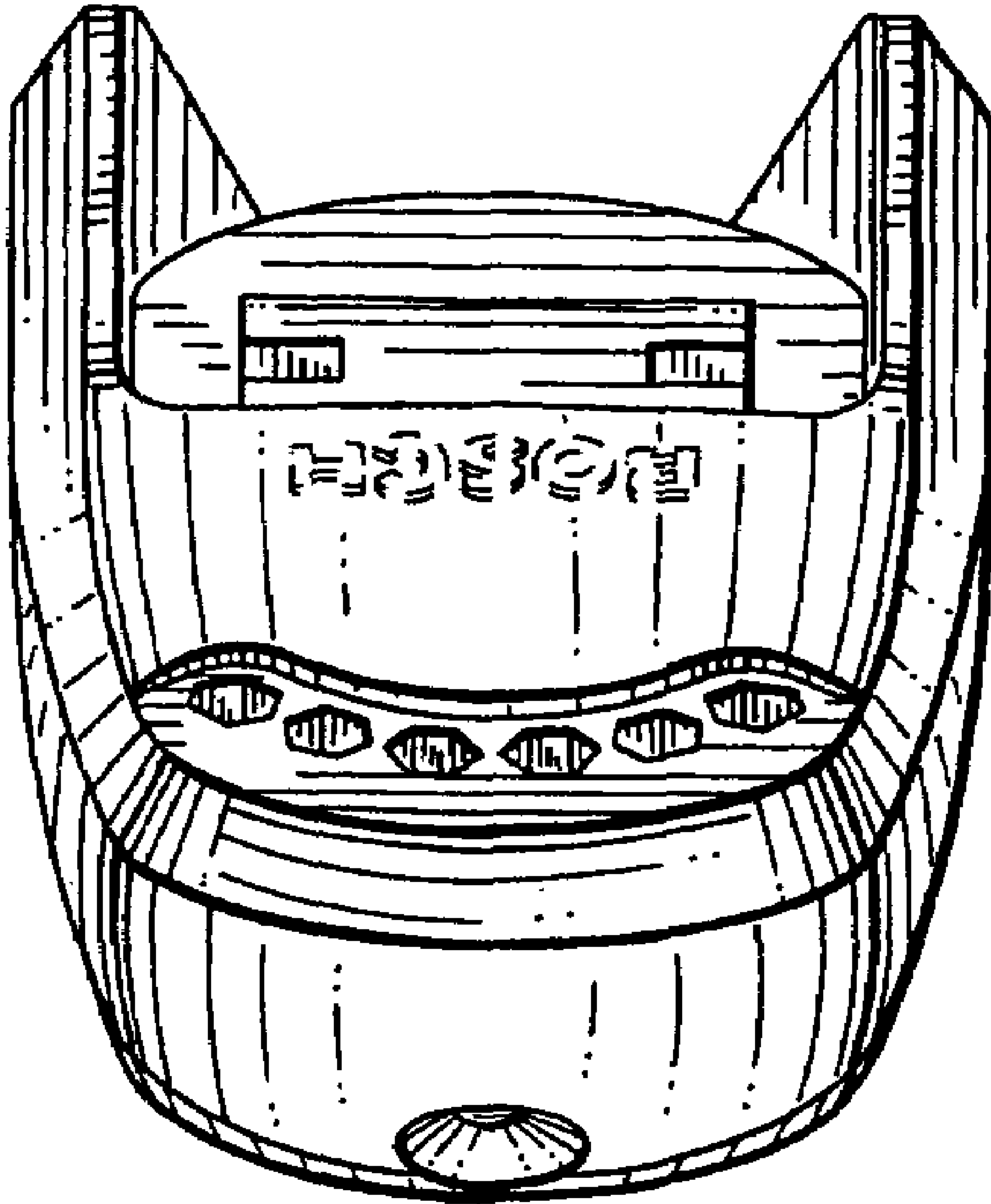

FIG. 3

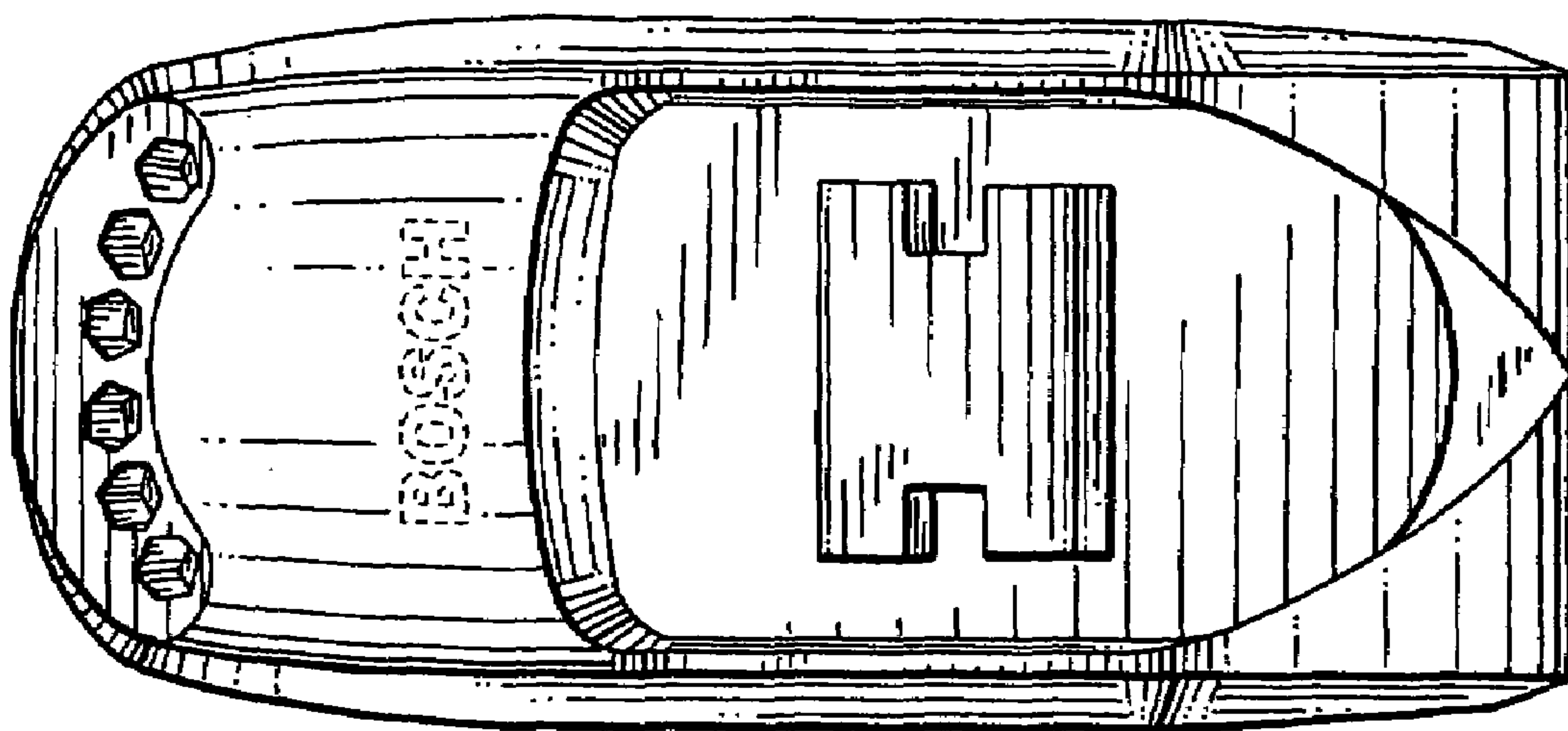

FIG. 4

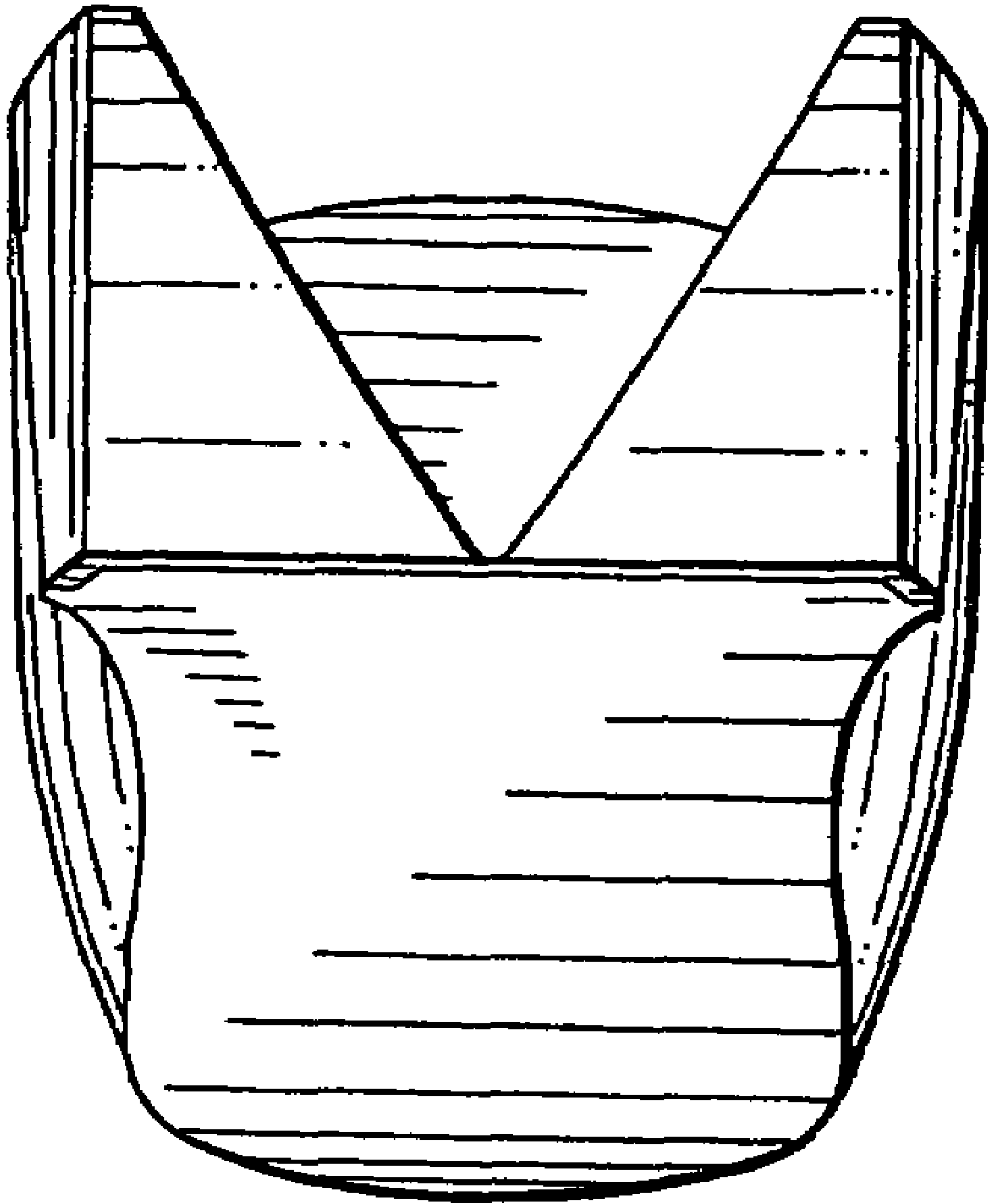

FIG. 5

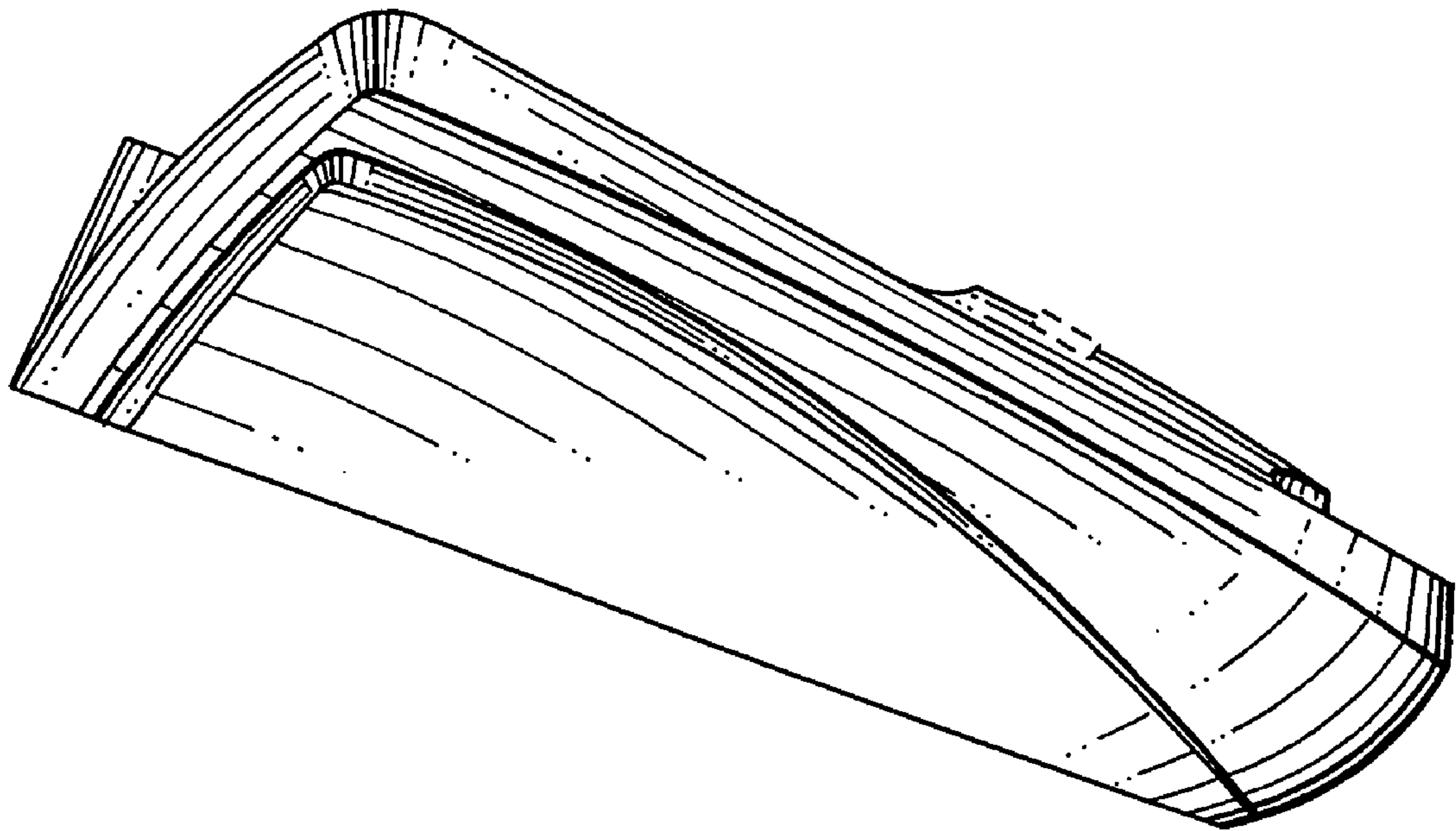

FIG. 6

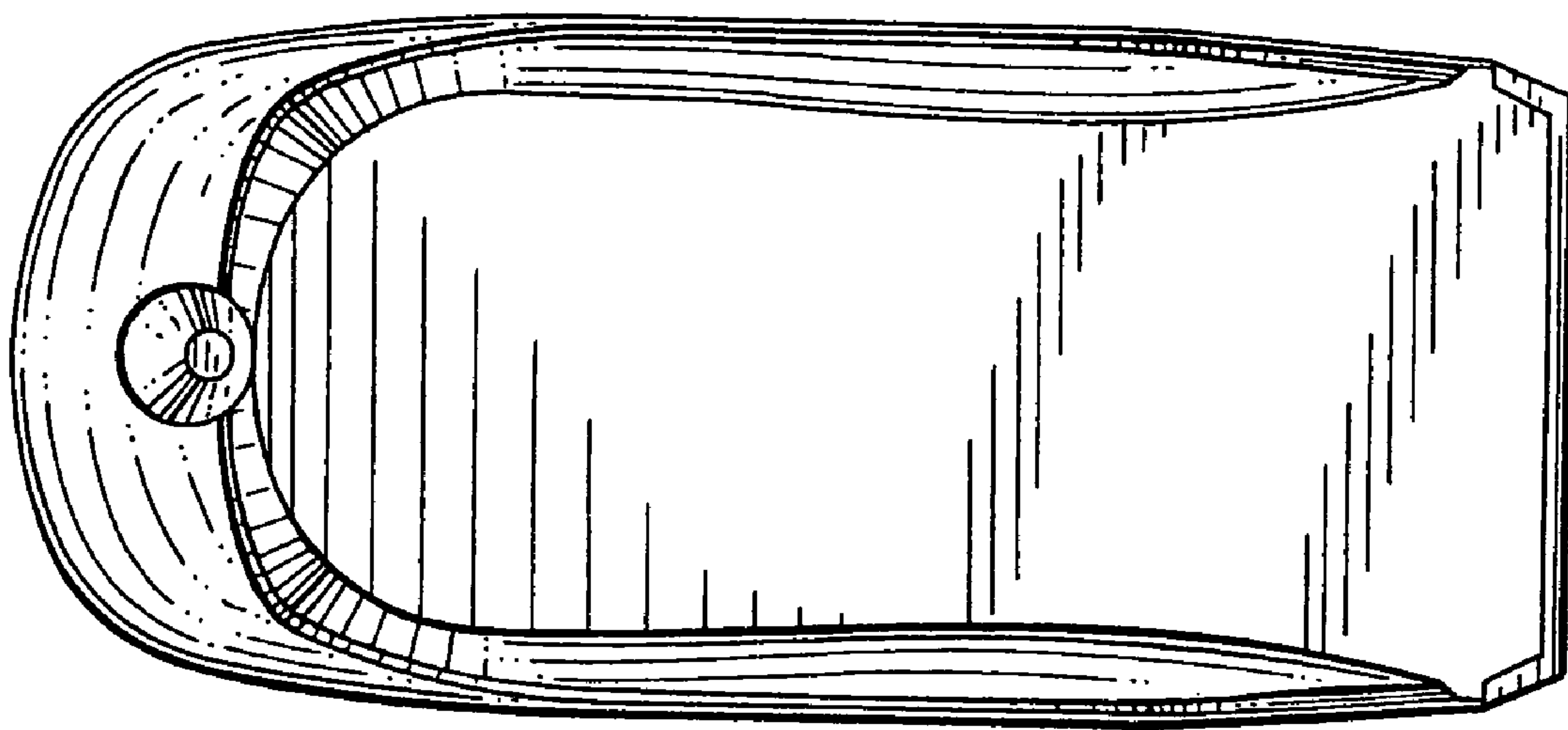

FIG. 7