



US00D551607S

(12) **United States Design Patent**  
**LaRussa**

(10) **Patent No.:** **US D551,607 S**

(45) **Date of Patent:** **\*\* Sep. 25, 2007**

(54) **EXHAUST PIPE**

(76) **Inventor:** **Dino LaRussa**, 12402 N. Division  
#238, Spokane, WA (US) 99218

(\*\*) **Term:** **14 Years**

(21) **Appl. No.:** **29/257,054**

(22) **Filed:** **Mar. 28, 2006**

(51) **LOC (8) Cl.** ..... **12-16**

(52) **U.S. Cl.** ..... **D12/194**

(58) **Field of Classification Search** ..... D12/194;  
D15/5; 181/227, 228; 60/313, 323, 324,  
60/274; 29/890.08; 123/312, 315

See application file for complete search history.

(56) **References Cited**

**U.S. PATENT DOCUMENTS**

3,453,824	A	*	7/1969	Biesecker	.....	60/313
D266,167	S	*	9/1982	Lindbrandt	.....	D15/5
D266,168	S	*	9/1982	Lindbrandt	.....	D15/5
D278,326	S	*	4/1985	Equi	.....	D12/194
D299,917	S	*	2/1989	Lessel	.....	D12/194
D414,452	S	*	9/1999	Verlengiere	.....	D12/194
D435,498	S	*	12/2000	Bassani	.....	D12/194
D454,320	S	*	3/2002	Martin	.....	D12/194
D460,726	S	*	7/2002	Campbell et al.	.....	D12/194

D481,662	S	*	11/2003	James	.....	D12/194
D483,710	S	*	12/2003	James	.....	D12/194
D501,812	S	*	2/2005	Ramelot	.....	D12/194
D520,423	S	*	5/2006	Poole	.....	D12/194
D520,424	S	*	5/2006	Hawkins	.....	D12/194
D520,925	S	*	5/2006	Savage et al.	.....	D12/194

\* cited by examiner

*Primary Examiner*—Doris Clark

*Assistant Examiner*—Michael Pratt

(74) *Attorney, Agent, or Firm*—Wells St. John, P.S.

(57) **CLAIM**

I claim the ornamental design for an exhaust pipe, as shown and described.

**DESCRIPTION**

FIG. 1 is a perspective view of the exhaust pipe;

FIG. 2 is a top view of the exhaust pipe;

FIG. 3 is a bottom view of the exhaust pipe;

FIG. 4 is a front elevation view of the exhaust pipe;

FIG. 5 is a rear elevation view of the exhaust pipe;

FIG. 6 is a first side view of the exhaust pipe; and,

FIG. 7 is a second side view of the exhaust pipe.

**1 Claim, 5 Drawing Sheets**

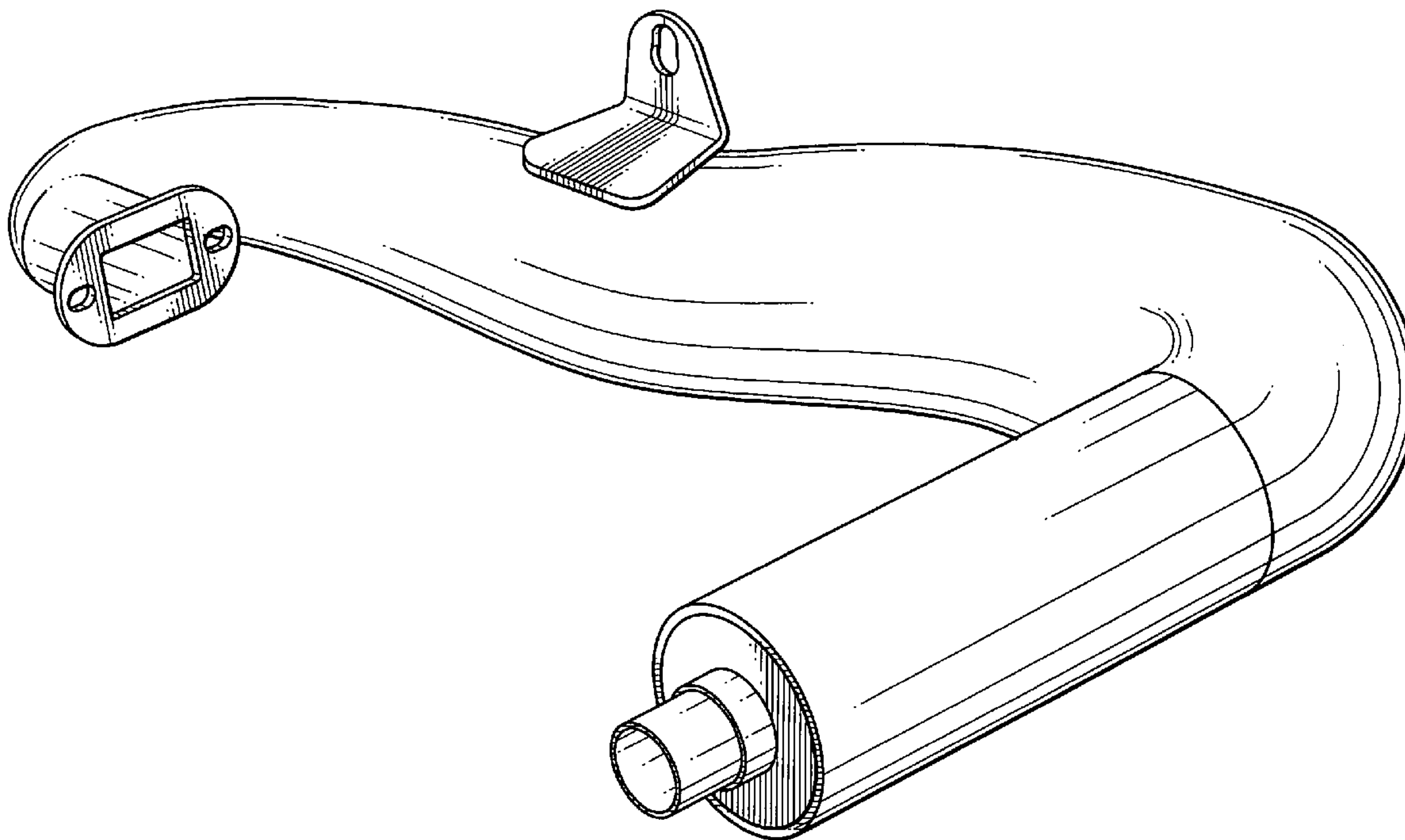

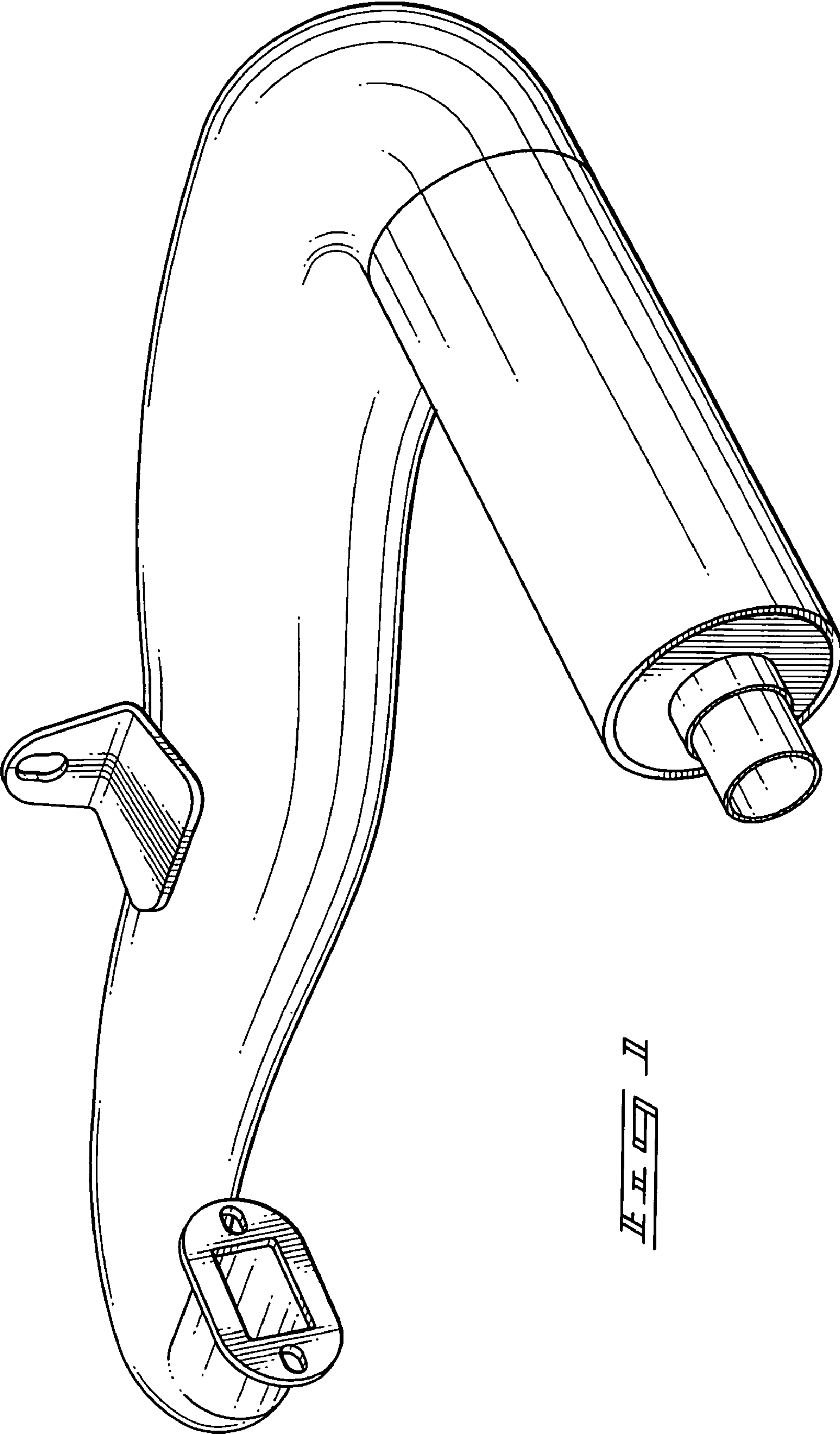
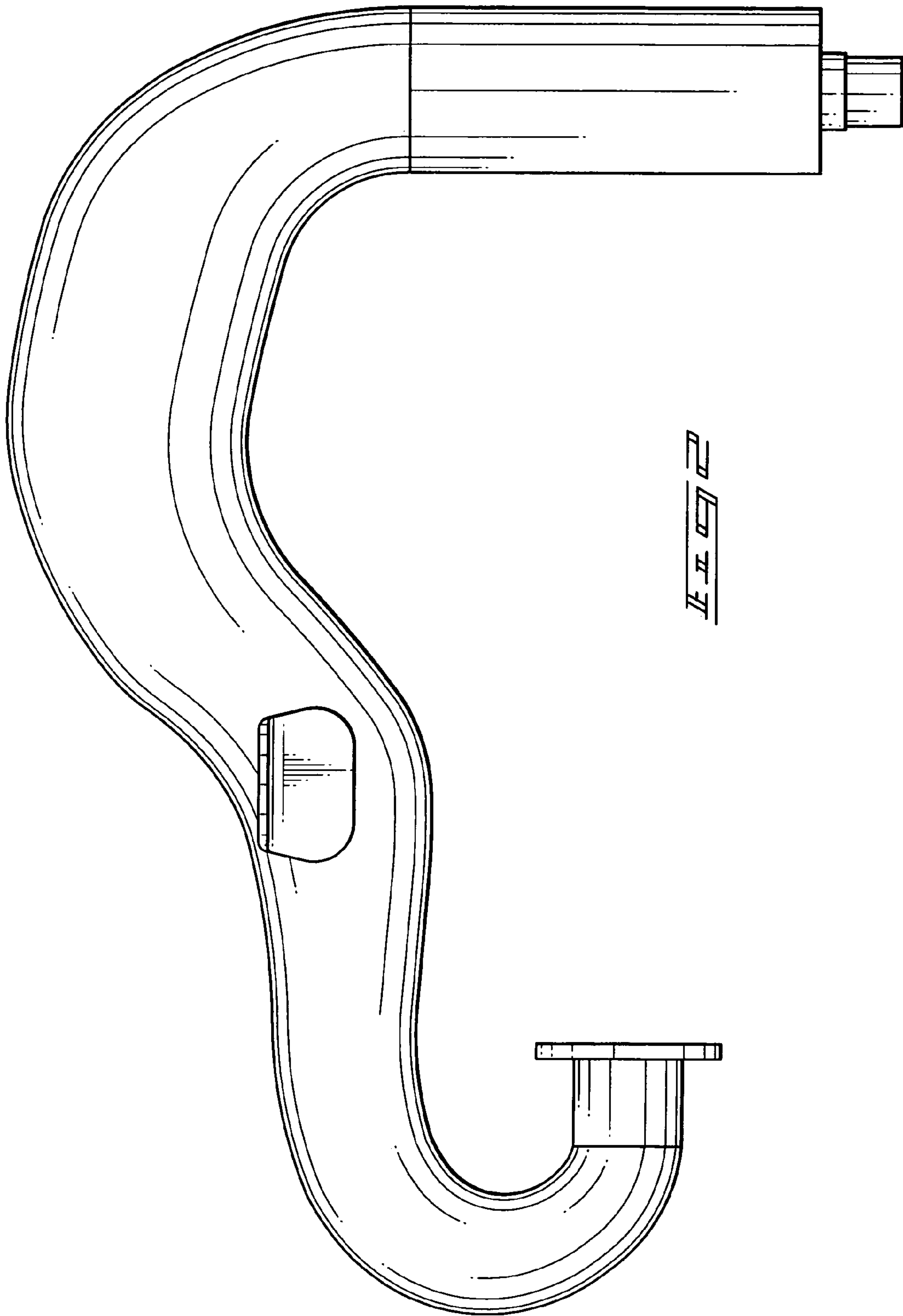

FIG. 1



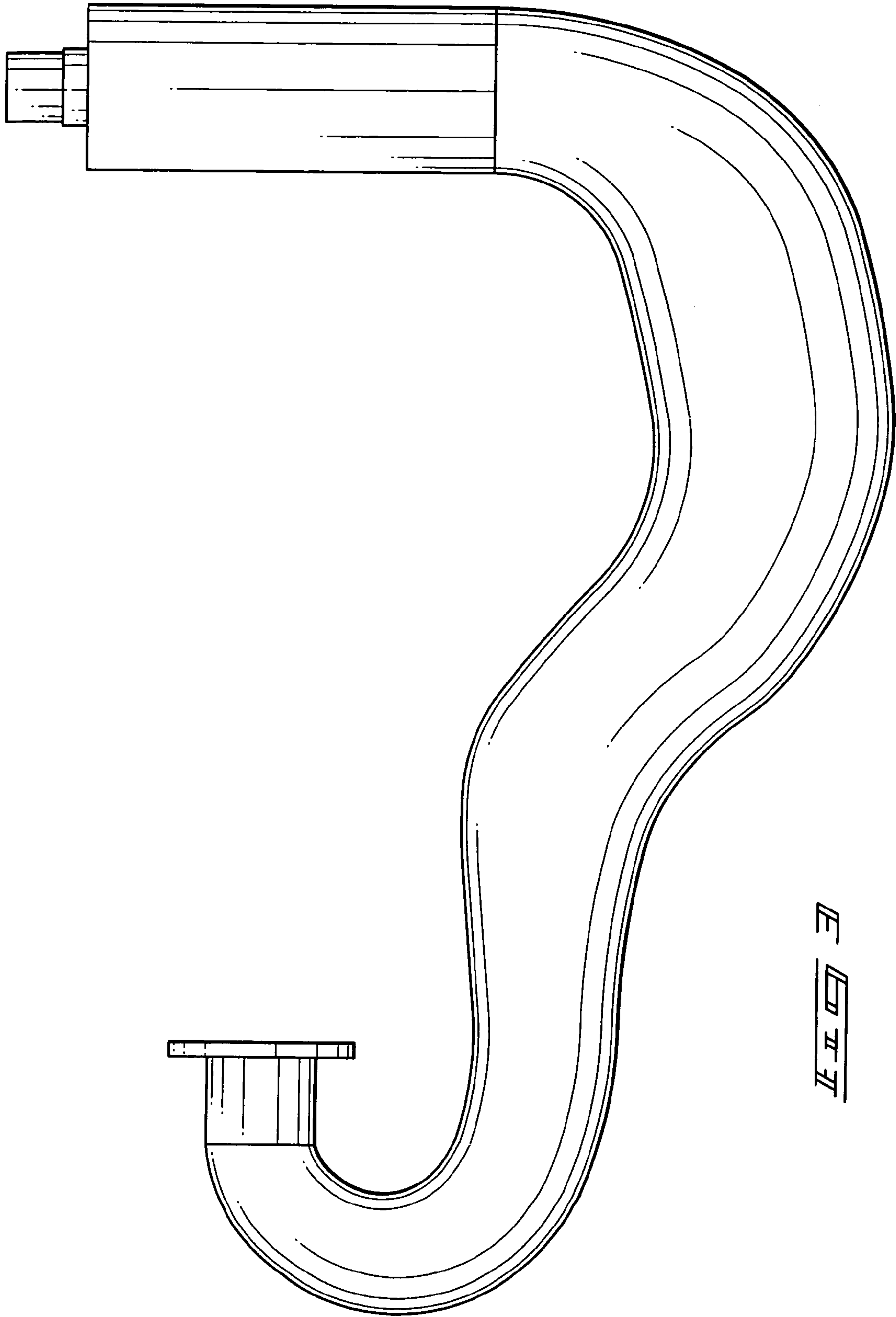
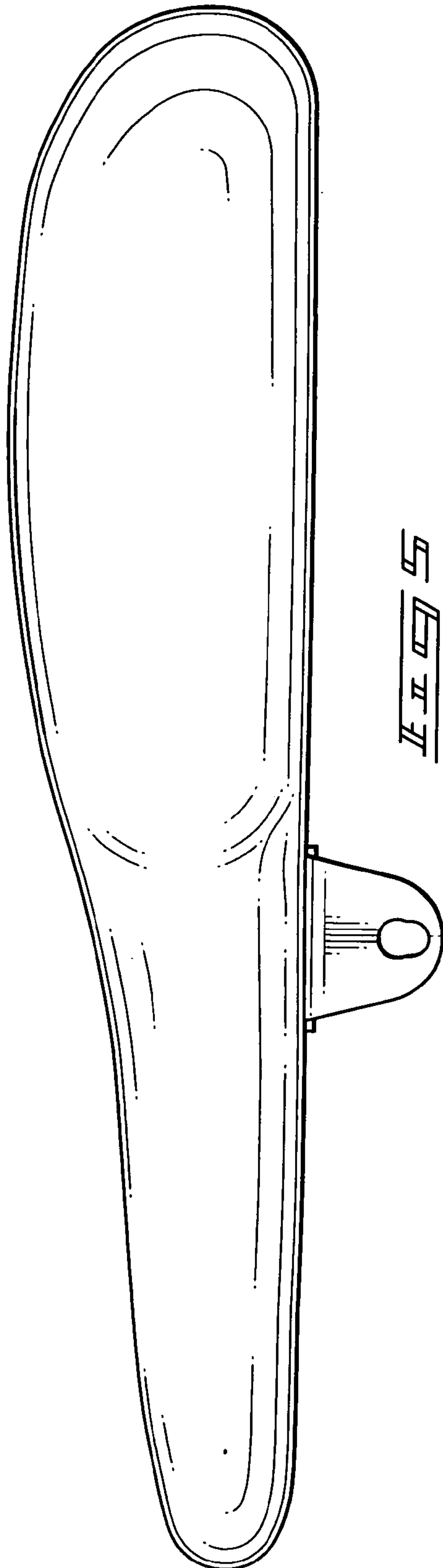
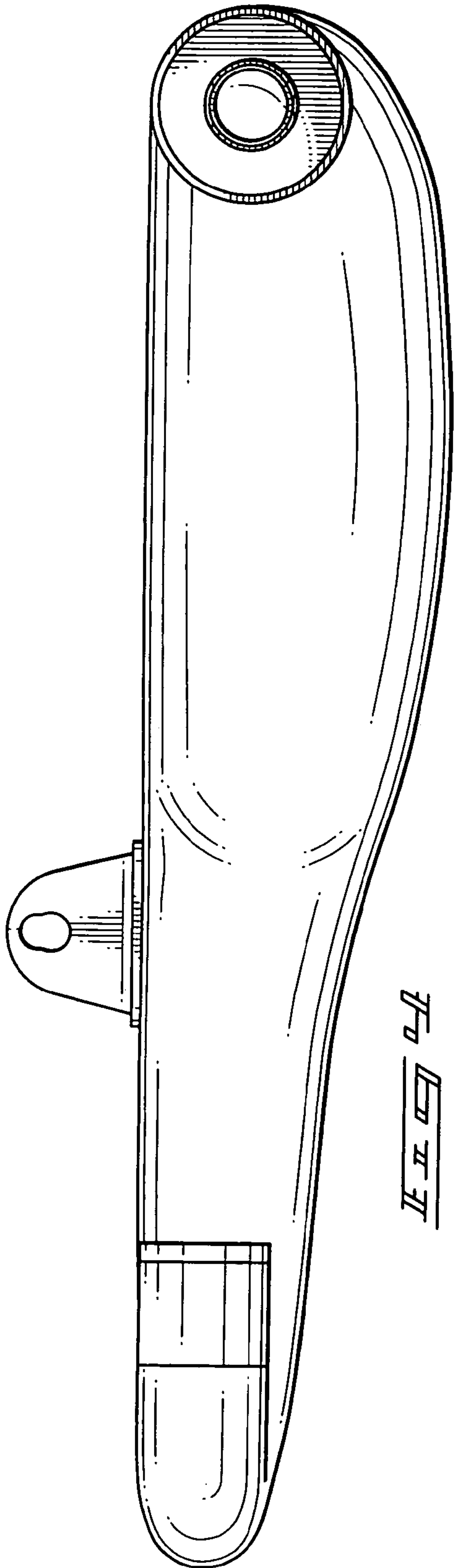

FIG. 3





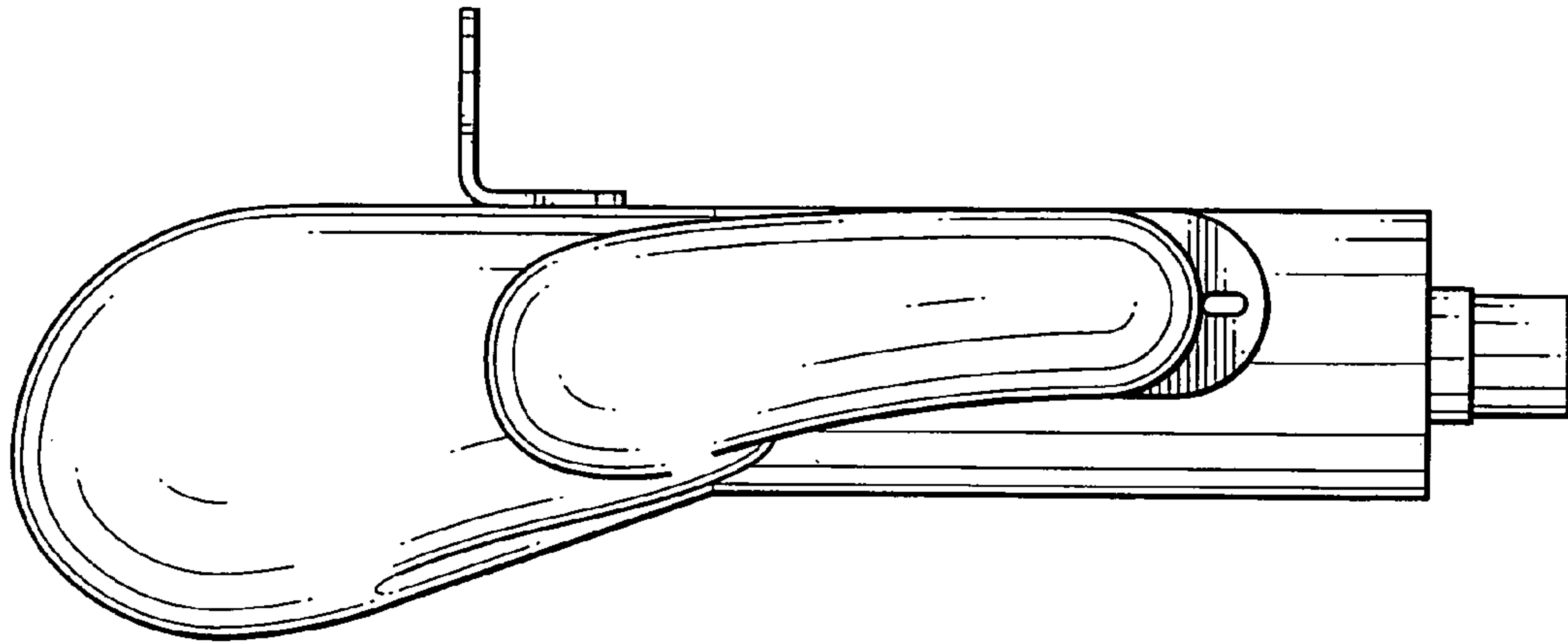

FIG. 6

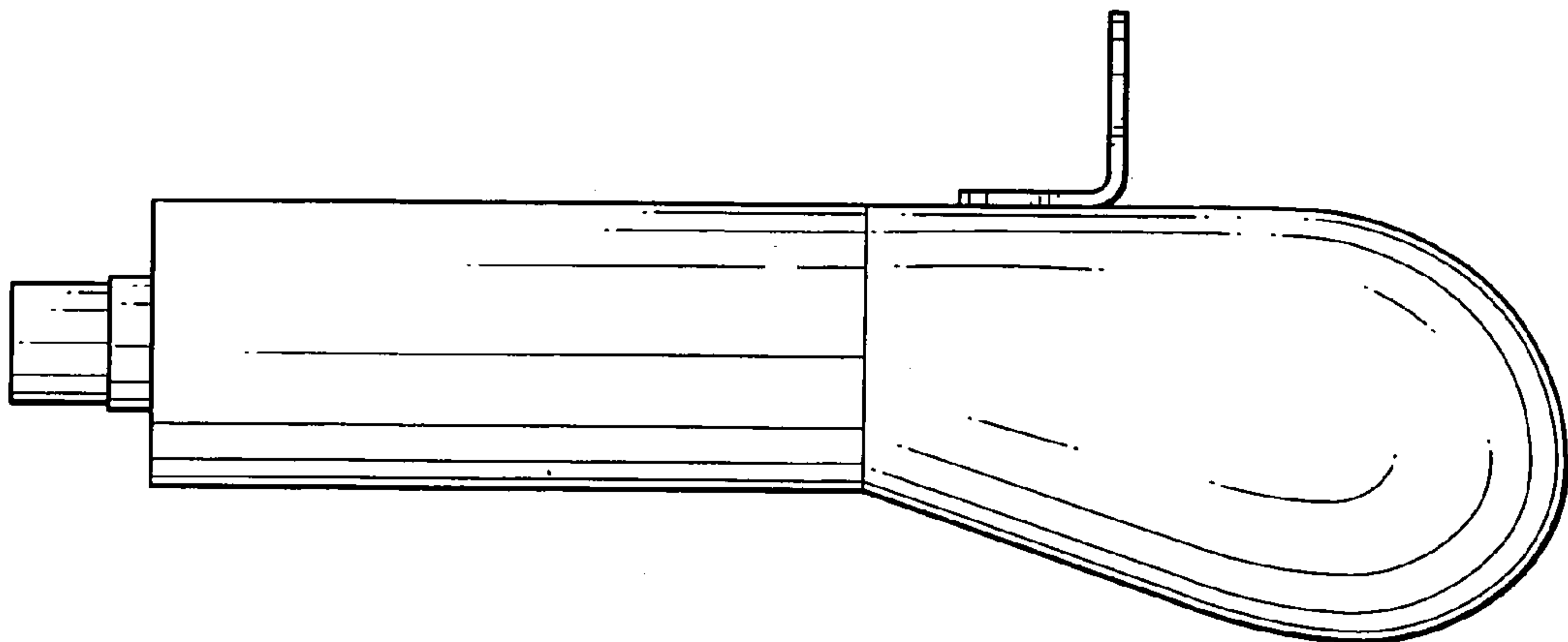

FIG. 7