



US00D551569S

(12) **United States Design Patent** (10) **Patent No.:** **US D551,569 S**
Tanaka (45) **Date of Patent:** **** Sep. 25, 2007**

(54) **COMBINED CONTAINER AND CAP**

(75) Inventor: **Akinori Tanaka**, Osaka (JP)

(73) Assignee: **Alteco Inc.**, Osaka (JP)

(**) Term: **14 Years**

(21) Appl. No.: **29/261,245**

(22) Filed: **Jun. 12, 2006**

(51) **LOC (8) Cl.** **09-03**

(52) **U.S. Cl.** **D9/724**

(58) **Field of Classification Search** D9/723,
D9/724, 727, 414, 424, 516, 529, 563, 571-574,
D9/549, 550, 558, 688; D6/512, 515; D3/201,
D3/203.1, 203.5; D24/100, 107; D28/4,
D28/7, 9, 73, 76, 85, 89; D19/35, 36, 41,
D19/43, 45, 47, 51; 206/385; 221/303,
221/312 R; 222/1, 71, 173, 566, 630, 631;
604/295; 606/204.25

See application file for complete search history.

(56) **References Cited**

U.S. PATENT DOCUMENTS

D299,973 S	2/1989	Campello et al.	
D306,914 S *	3/1990	Shinohara	D28/7
D318,538 S *	7/1991	Shinohara	D28/7
D325,264 S *	4/1992	Shinohara	D28/7
D337,259 S *	7/1993	Curtis et al.	D9/688
D369,384 S *	4/1996	Yasoshima	D19/36
D375,256 S *	11/1996	Chadfield	D9/724
D386,679 S *	11/1997	Beaver	D9/724
D391,166 S *	2/1998	Lang	D9/529
D430,705 S *	9/2000	Lang	D28/89
D460,485 S *	7/2002	Keda	D19/43
D471,797 S *	3/2003	Guerrera et al.	D9/724
D529,817 S *	10/2006	Francavilla et al.	D9/724

FOREIGN PATENT DOCUMENTS

JP D1053275 S 11/1999

* cited by examiner

Primary Examiner—Mitchell Siegel

Assistant Examiner—Shanda C. Hill

(74) *Attorney, Agent, or Firm*—Rader, Fishman & Grauer PLLC

(57) **CLAIM**

The ornamental design for a combined container and cap, as shown and described.

DESCRIPTION

FIG. 1 is a perspective view of the combined container and cap showing my new design, shown with the cap removed for clarity of illustration;

FIG. 2 is a perspective view of the combined container and cap;

FIG. 3 is a top plan view of FIG. 2;

FIG. 4 is a bottom plan view of FIG. 2;

FIG. 5 is a front elevational view of FIG. 2, the rear elevational view being a mirror image;

FIG. 6 is a right side elevational view of FIG. 2, the left side elevational view being a mirror image;

FIG. 7 is a top plan view of the cap of the combined container and cap;

FIG. 8 is a bottom plan view of FIG. 7;

FIG. 9 is a front elevational view of FIG. 7, the rear elevational view being a mirror image;

FIG. 10 is a right side elevational view of FIG. 7, the left side elevational view being a mirror image;

FIG. 11 is a top plan view of the container of the combined container and cap;

FIG. 12 is a bottom plan view of FIG. 11;

FIG. 13 is a front elevational view of FIG. 11;

FIG. 14 is a rear elevational view of FIG. 11;

FIG. 15 is a right side elevational view of FIG. 11;

FIG. 16 is a left side elevational view of FIG. 11; and,

FIG. 17 is a cross-sectional view taken along line XVII-XVII of FIG. 3.

1 Claim, 17 Drawing Sheets

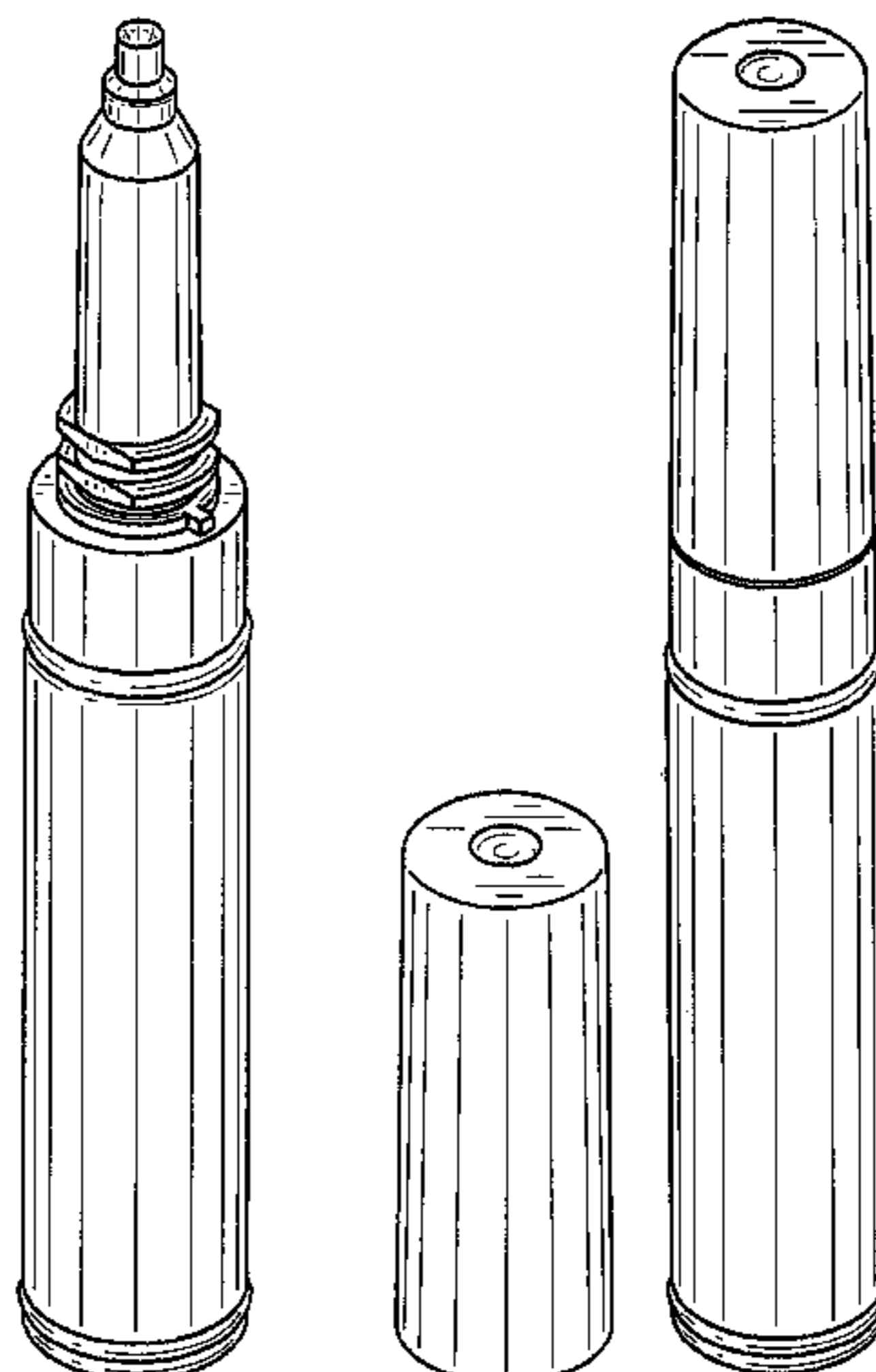

Fig. 1

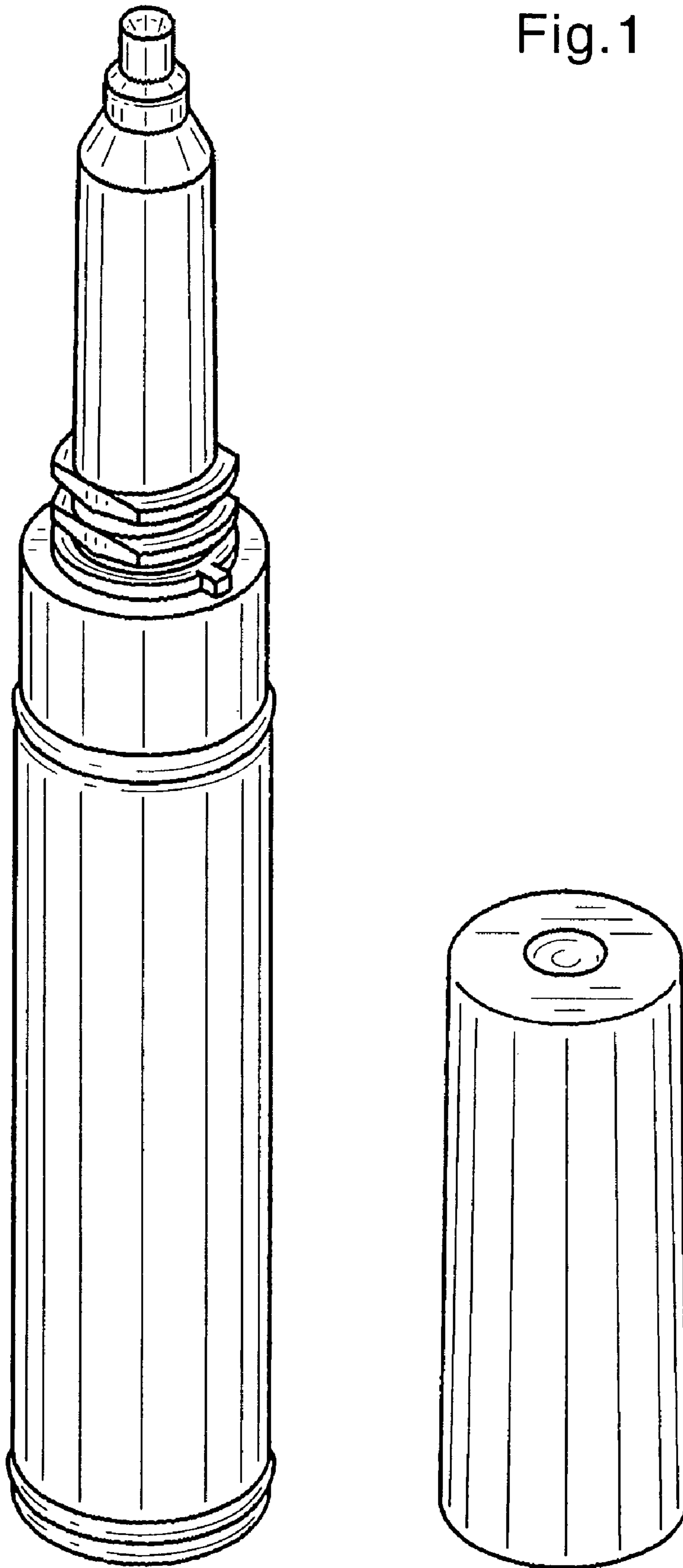

Fig.2

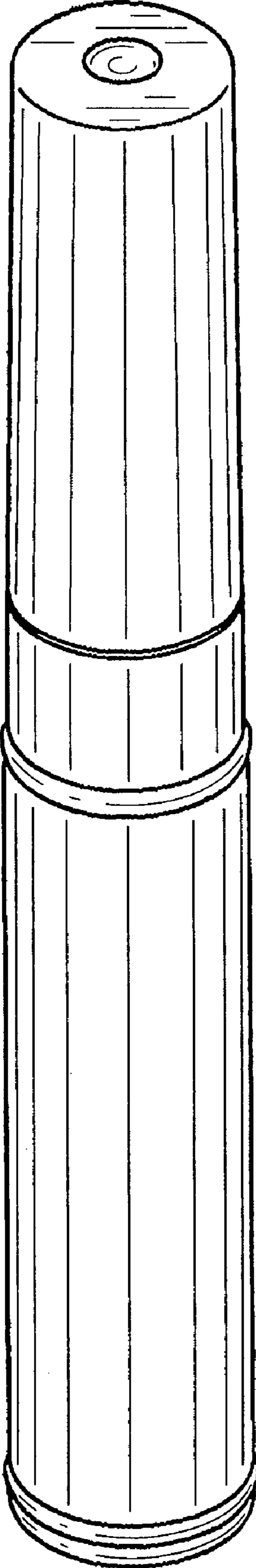

Fig.3

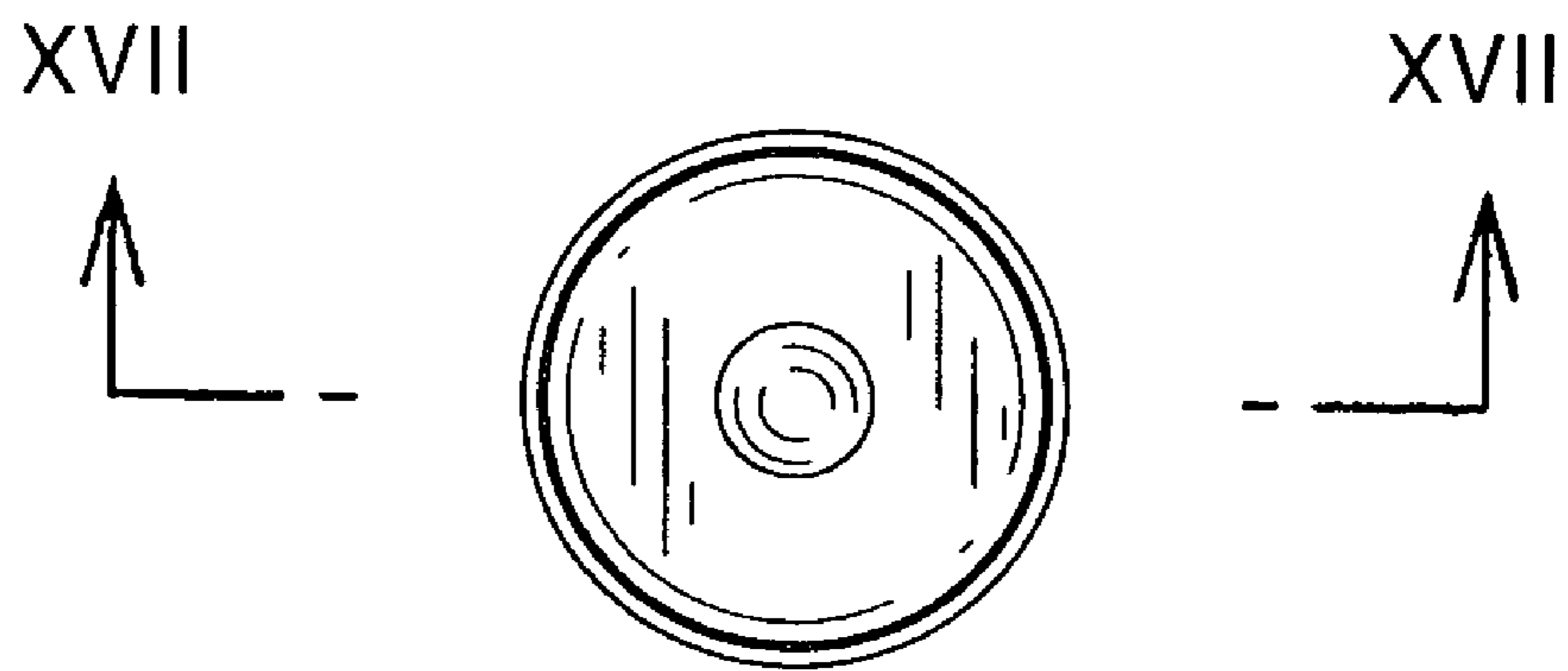

Fig.4

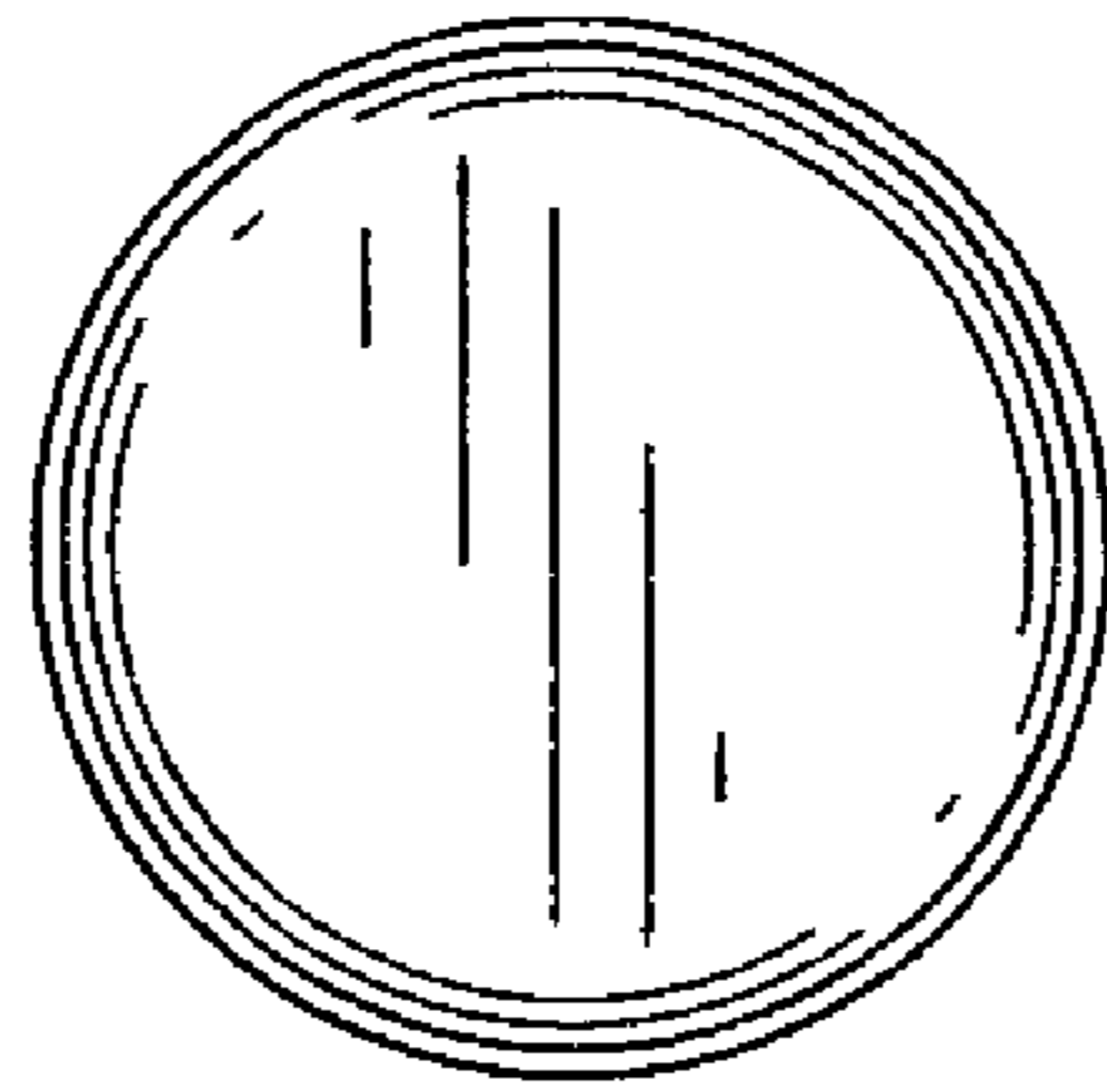

Fig.5

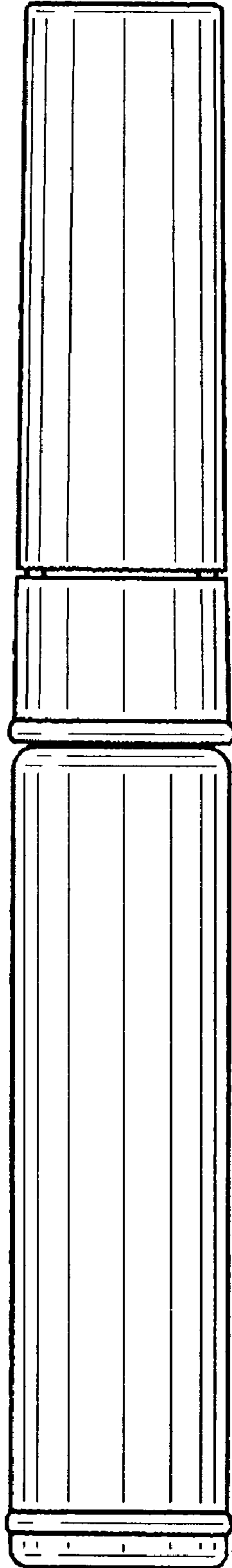

Fig.6

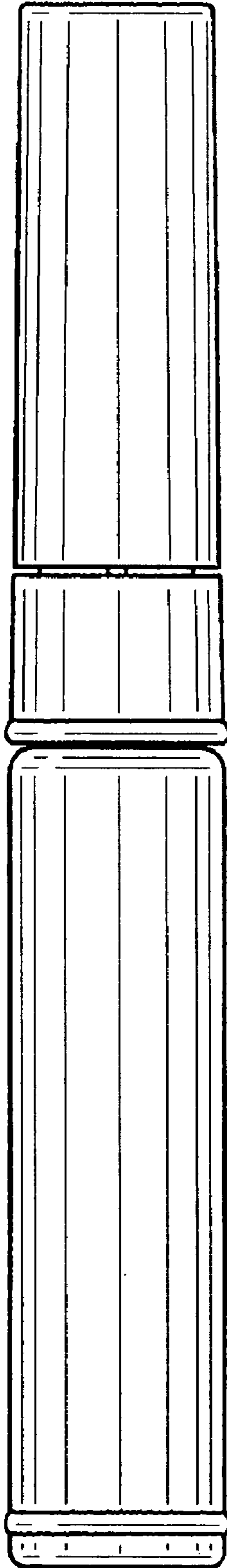

Fig.7

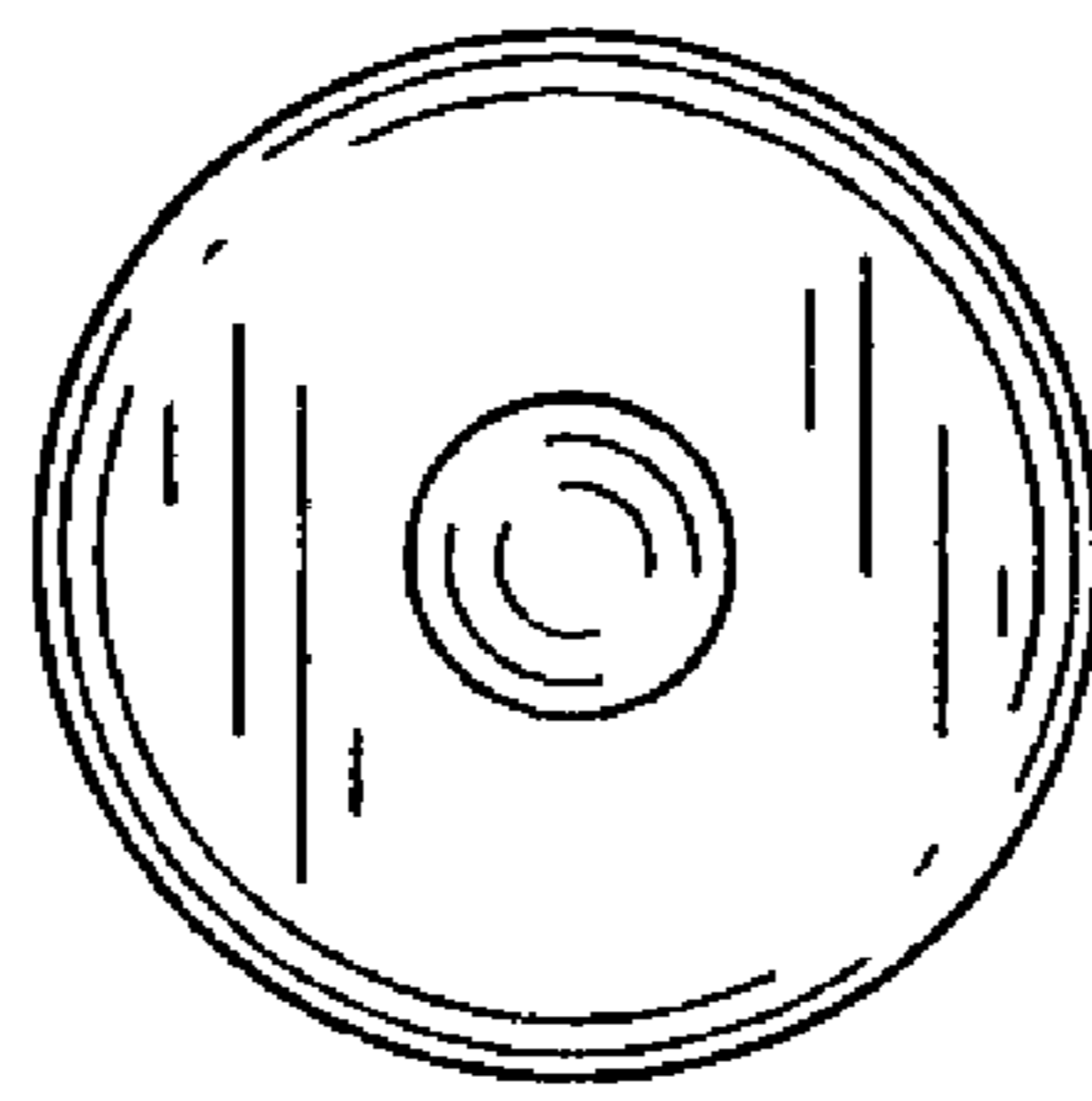

Fig.8



Fig.9

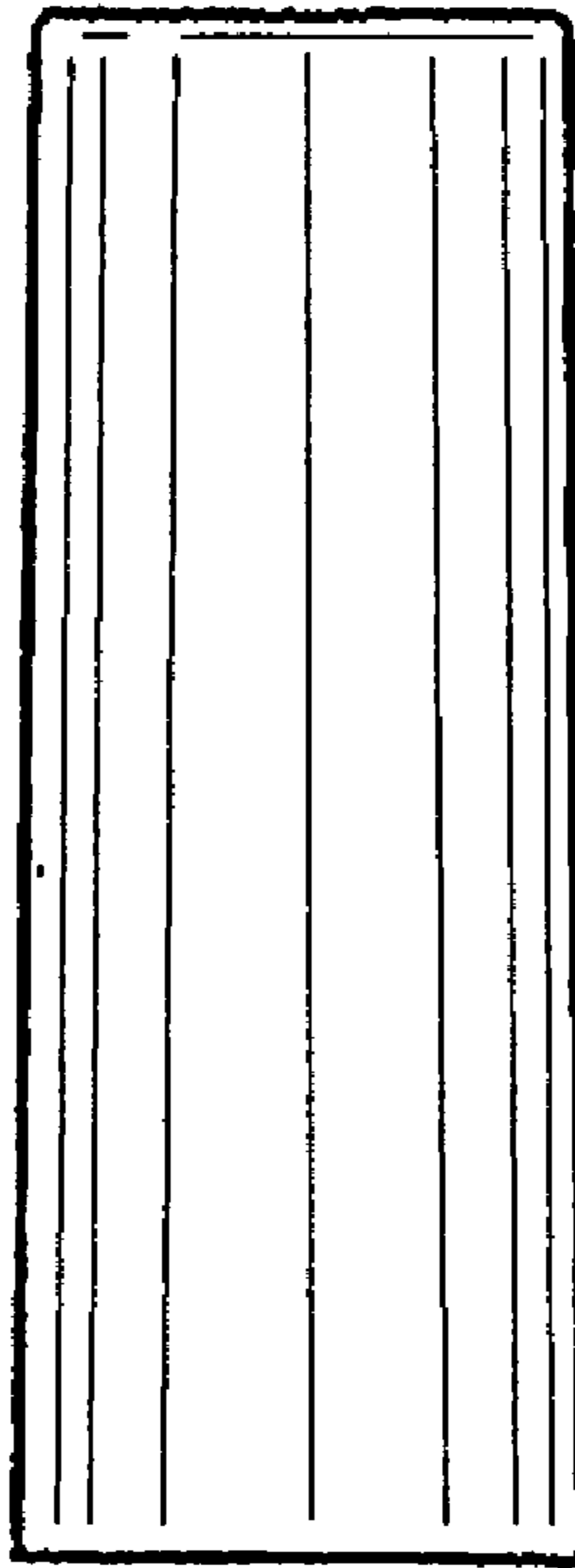

Fig. 10

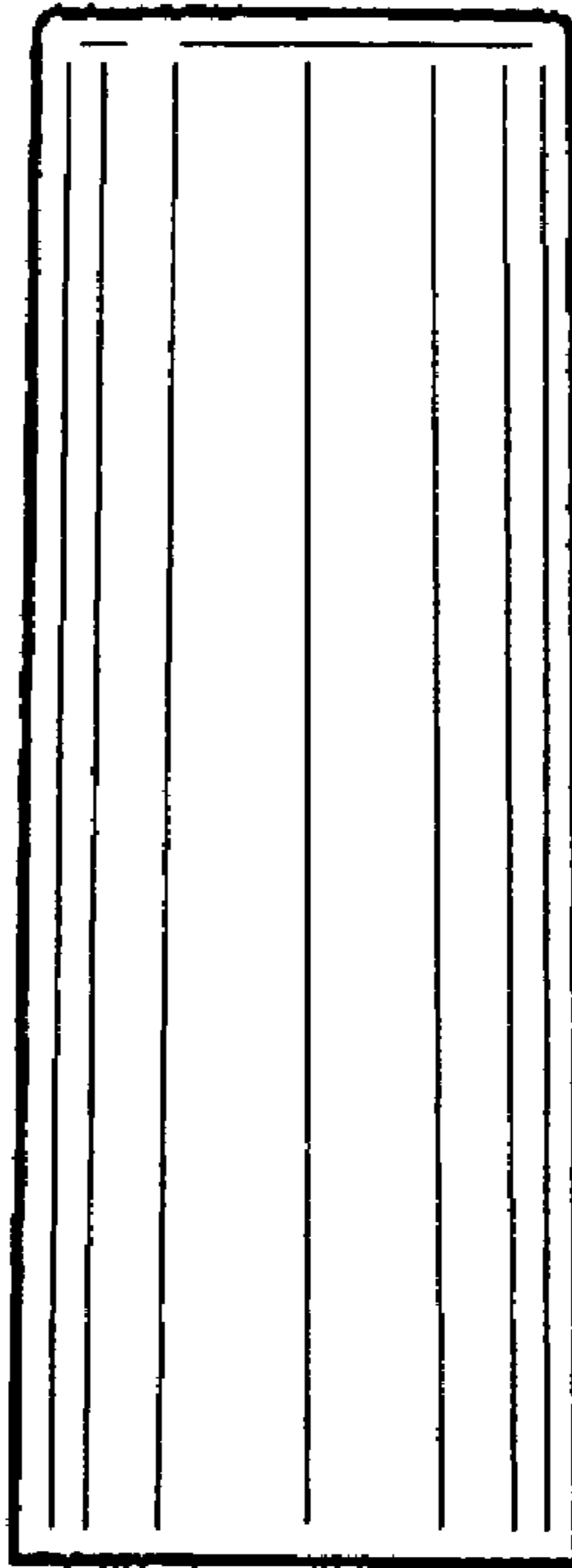

Fig. 11

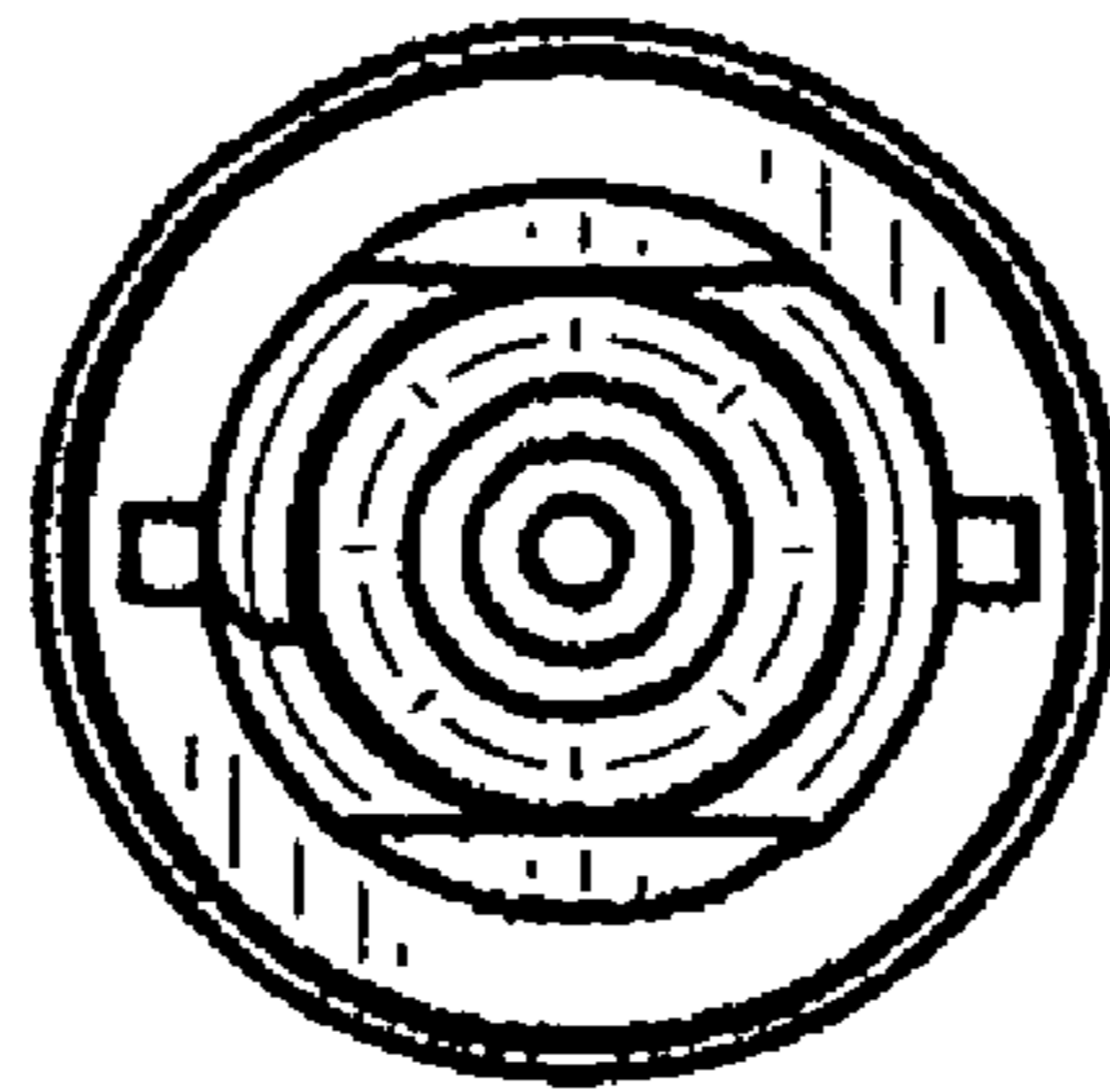

Fig.12

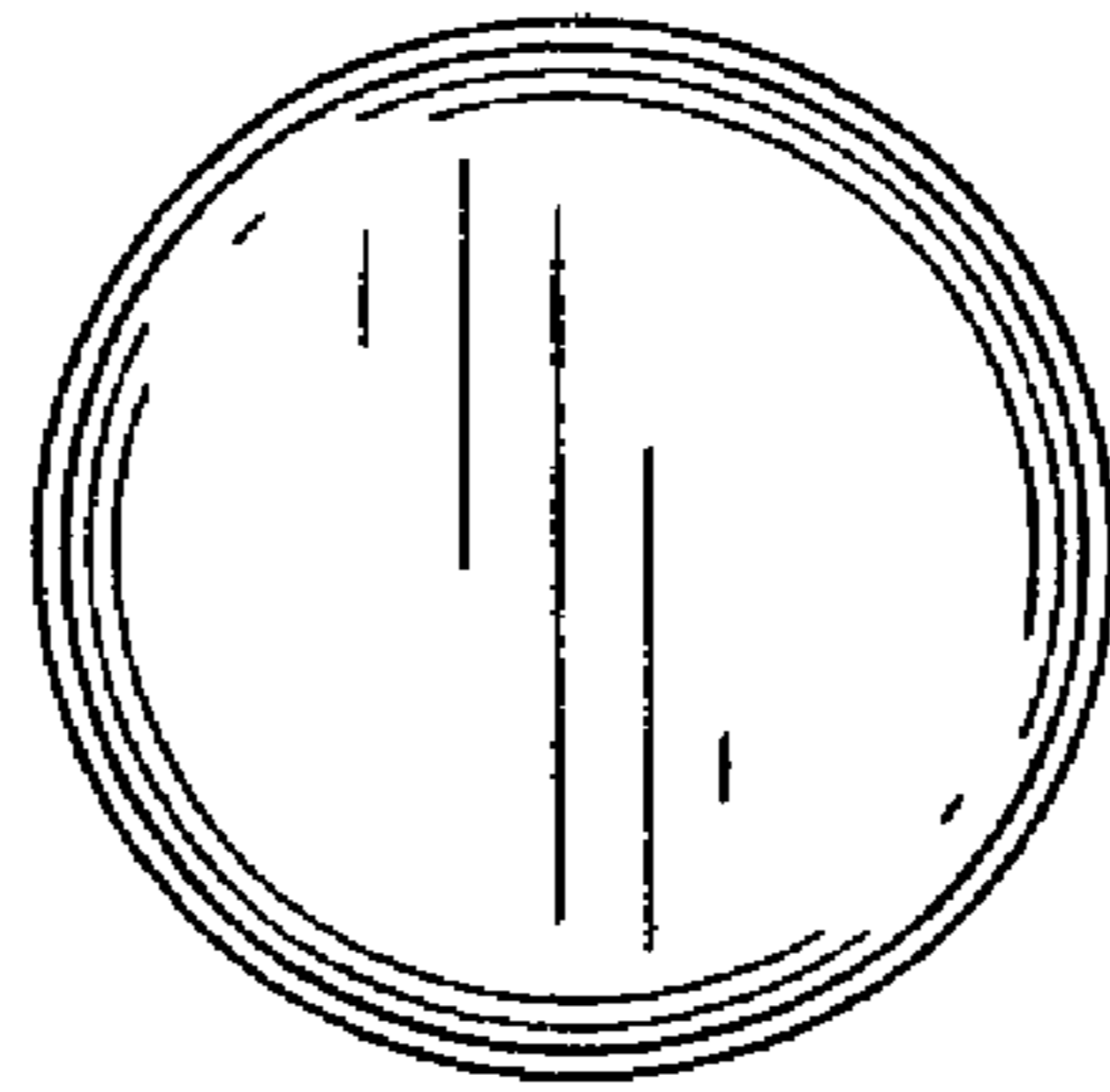

Fig. 13

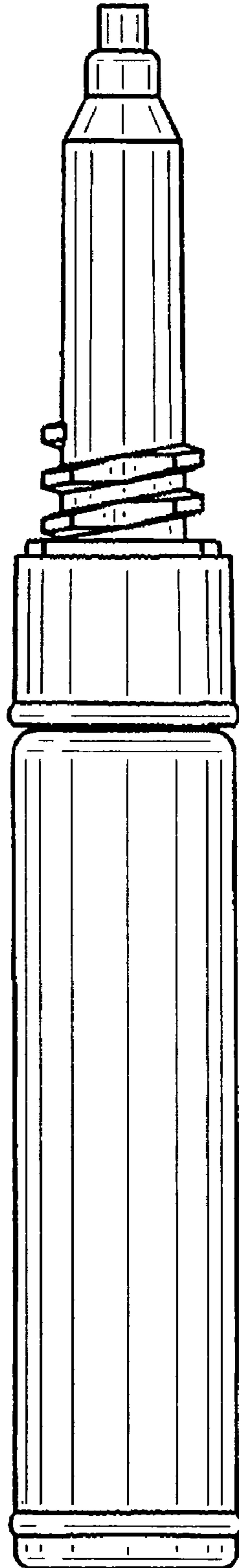

Fig.14

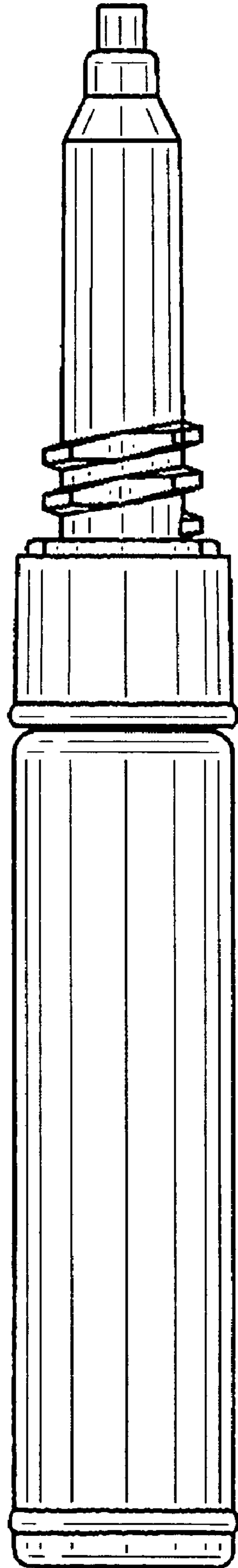

Fig. 15

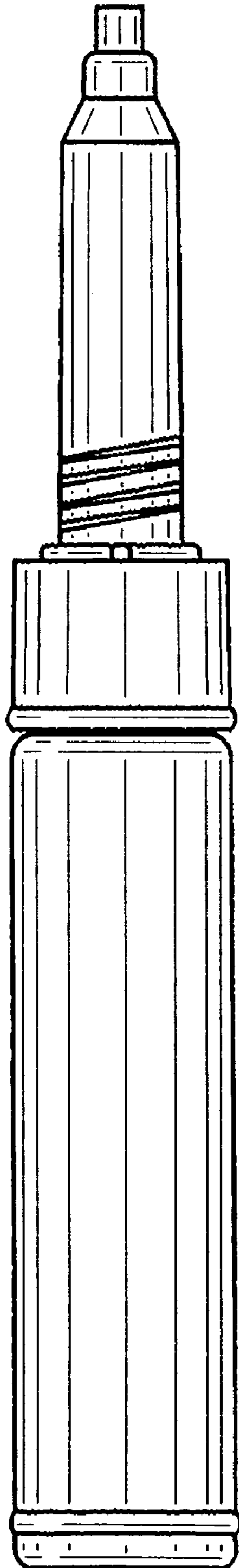

Fig. 16

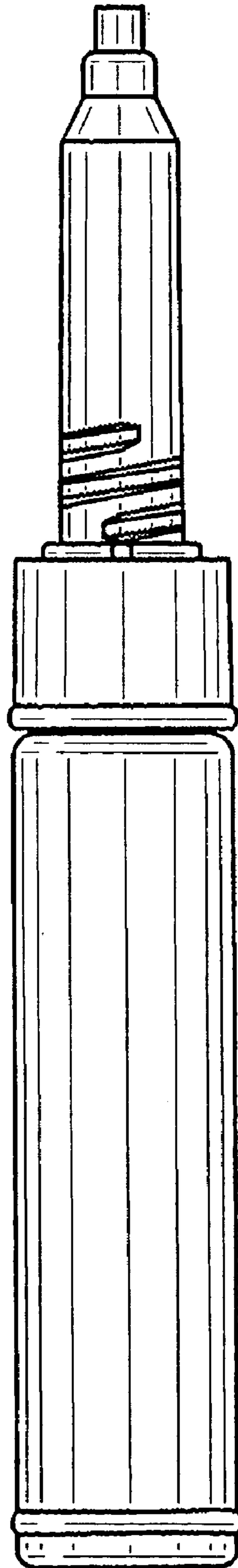

Fig. 17

