



US00D551456S

(12) **United States Design Patent** (10) **Patent No.:** **US D551,456 S**  
**Singh et al.** (45) **Date of Patent:** **\*\* Sep. 25, 2007**

(54) **WRENCH SET CASE** D436,441 S 1/2001 Lapidus  
D468,531 S 1/2003 Hsu  
(75) Inventors: **Satnam Singh**, Kitchener (CA); D473,713 S 4/2003 Chen  
**Mandeep Singh**, Kitchener (CA) D483,180 S 12/2003 Chen  
D511,040 S \* 11/2005 Barrios et al. .... D3/282  
(73) Assignee: **Maxtech Manufacturing Inc.**, D524,046 S \* 7/2006 Pangerc et al. .... D3/273  
Waterloo, Ontario (CA) 7,165,674 B2 \* 1/2007 Pangerc et al. .... 206/379  
2006/0042980 A1 \* 3/2006 Chen ..... 206/379

(\*\*) Term: **14 Years**

\* cited by examiner

(21) Appl. No.: **29/257,529**

*Primary Examiner*—Louis S. Zarfas

*Assistant Examiner*—Kathleen Sims

(22) Filed: **Apr. 6, 2006**

(74) *Attorney, Agent, or Firm*—Borden Ladner Gervais LLP

**Related U.S. Application Data**

(62) Division of application No. 29/229,852, filed on May 13, 2005, now Pat. No. Des. 528,797.

(57) **CLAIM**

We claim the ornamental design for wrench set case, as shown and described.

(51) **LOC (8) Cl.** ..... **03-01**  
(52) **U.S. Cl.** ..... **D3/315**  
(58) **Field of Classification Search** ..... D3/905,  
D3/273, 276, 283, 281, 291, 274, 282, 294–295,  
D3/315; 190/110, 111, 100; 220/752, 324,  
220/326; 206/349, 372, 373; 312/902  
See application file for complete search history.

**DESCRIPTION**

FIG. 1 is a perspective view of the front of the wrench set case;  
FIG. 2 is a perspective view of the rear of the wrench set case;  
FIG. 3 is a top view of the wrench set case;  
FIG. 4 is a front view of the wrench set case;  
FIG. 5 is a right hand side view of the wrench set case;  
FIG. 6 is a rear view of the wrench set case;  
FIG. 7 is a left hand side view of the wrench set case;  
FIG. 8 is a bottom view of the wrench set case; and,  
FIG. 9 is a perspective view of the wrench set case with the containers removed.

(56) **References Cited**

**U.S. PATENT DOCUMENTS**

4,449,629 A \* 5/1984 Barrieau ..... 206/765  
D367,557 S 3/1996 Chang  
D370,781 S \* 6/1996 Vasudeva ..... D3/284  
D382,115 S 8/1997 Chang  
D394,952 S 6/1998 Wei  
D400,709 S 11/1998 Chang  
D427,436 S \* 7/2000 Chan ..... D3/292  
D431,359 S 10/2000 Lapidus  
D434,561 S 12/2000 Vasudeva

**1 Claim, 4 Drawing Sheets**

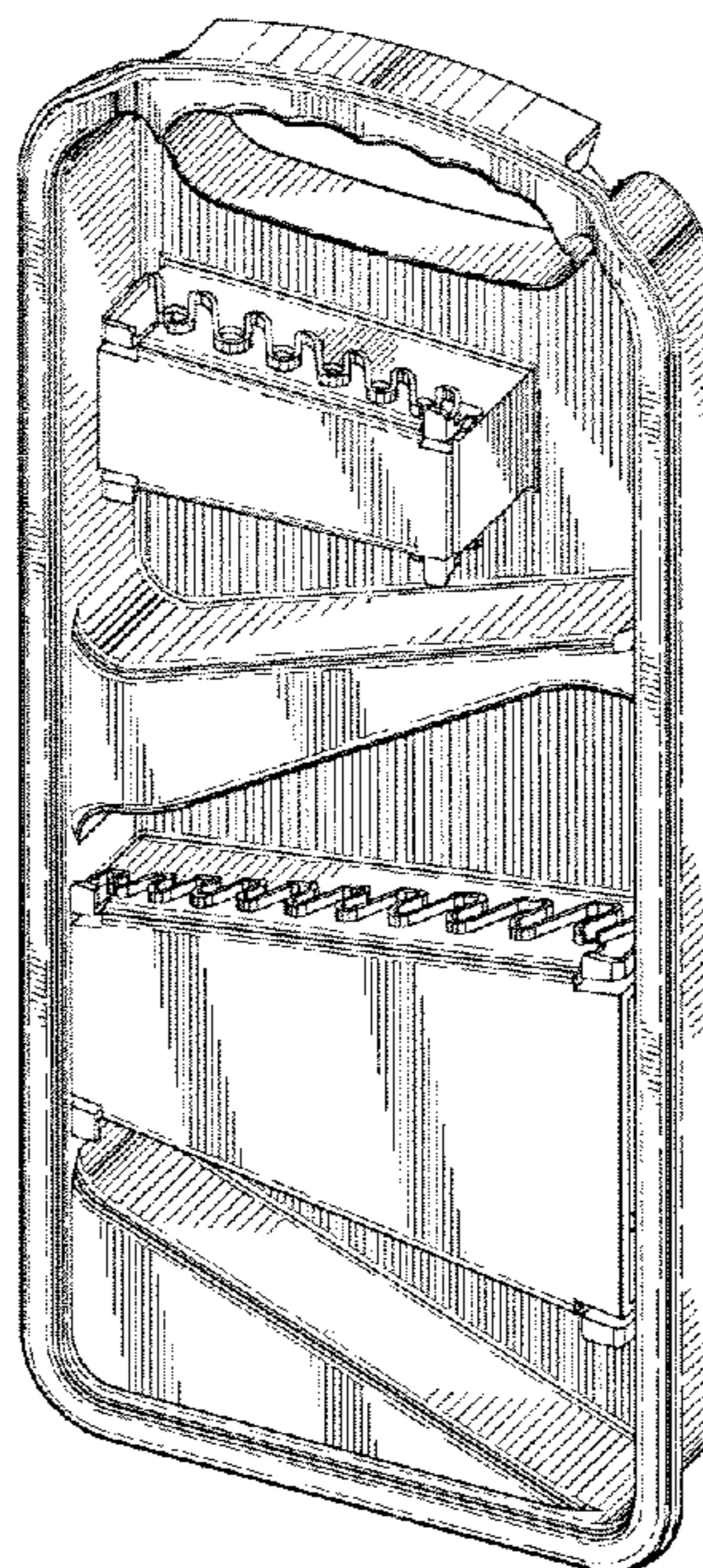

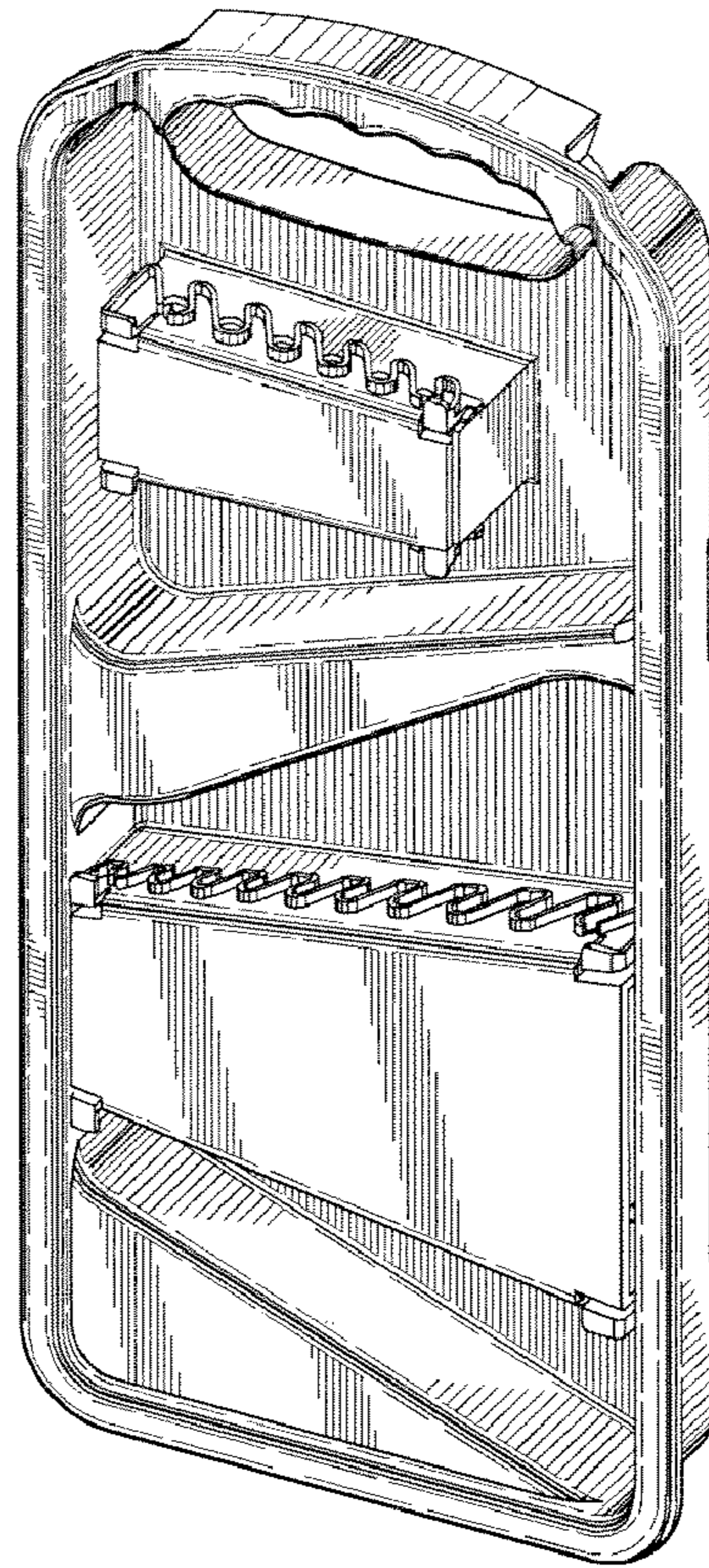

FIG. 1

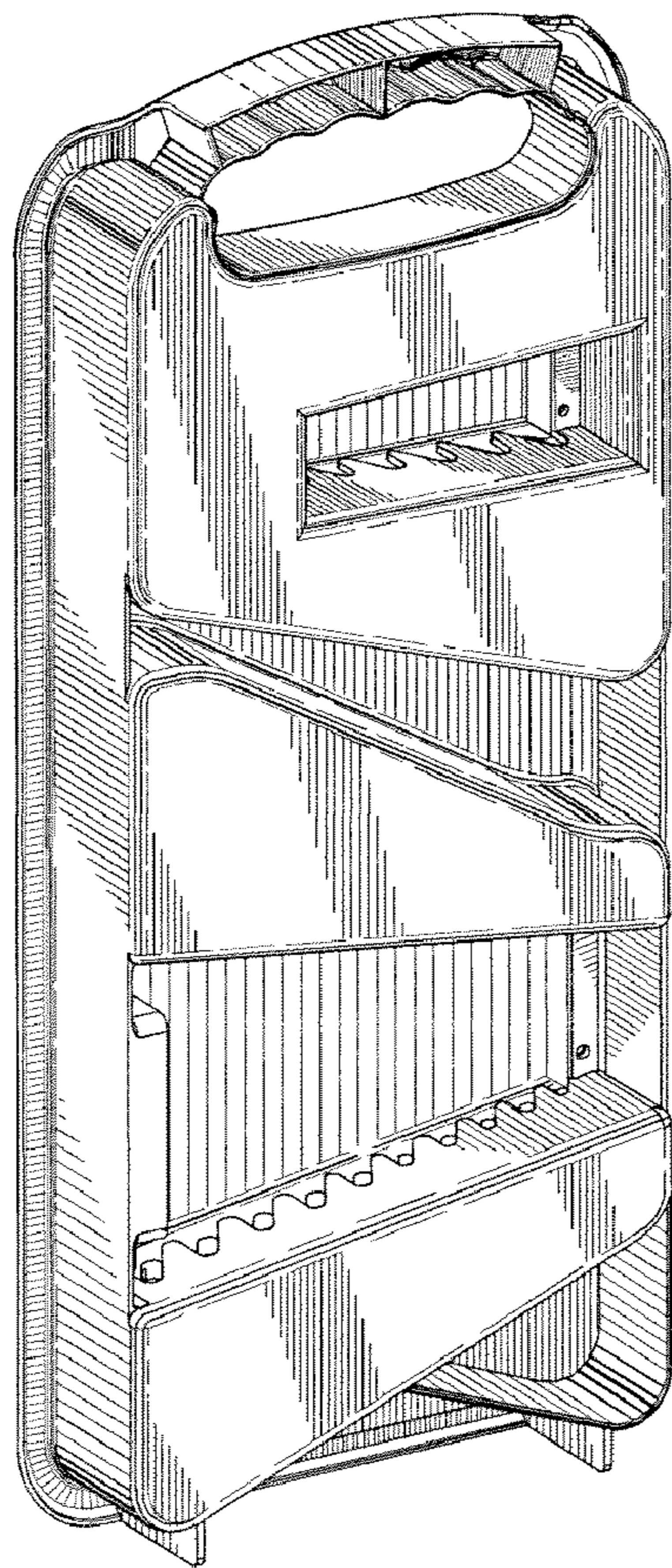

FIG. 2

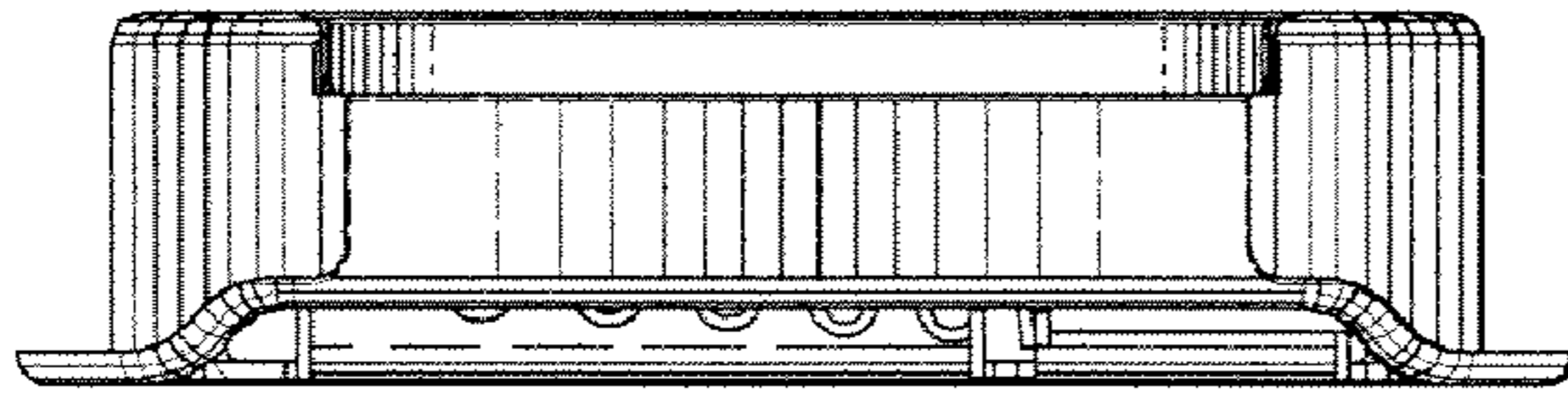

FIG. 3

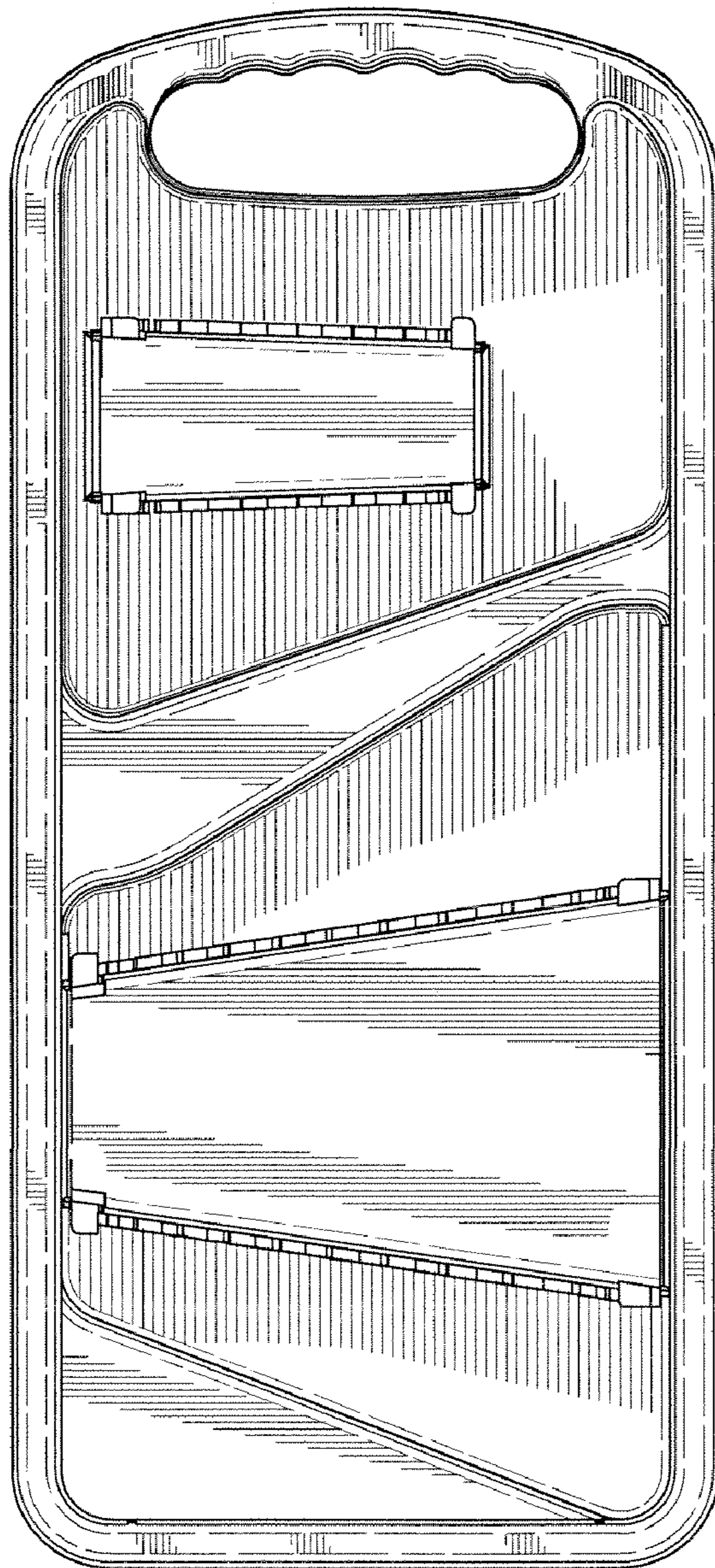

FIG. 4

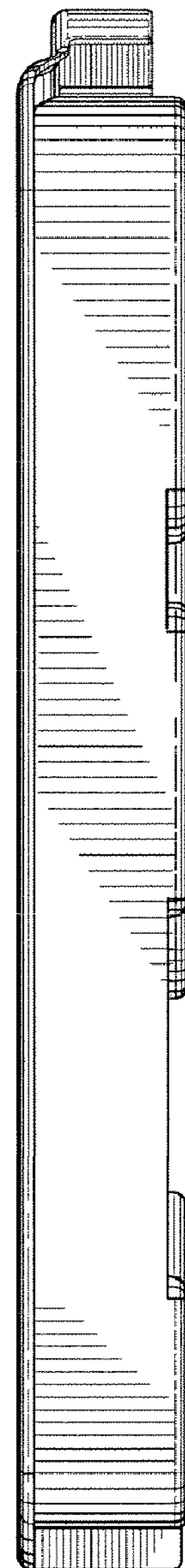

FIG. 5

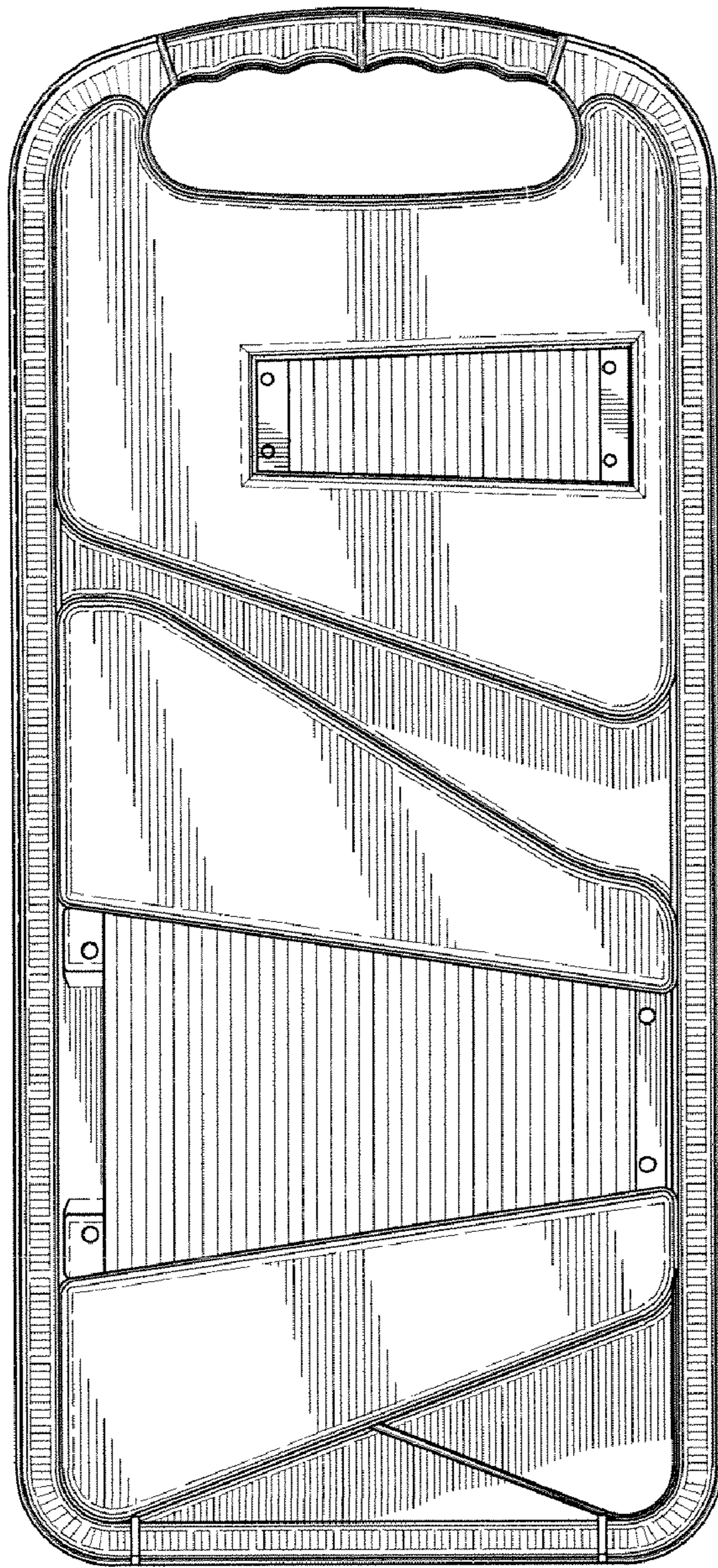

FIG. 6

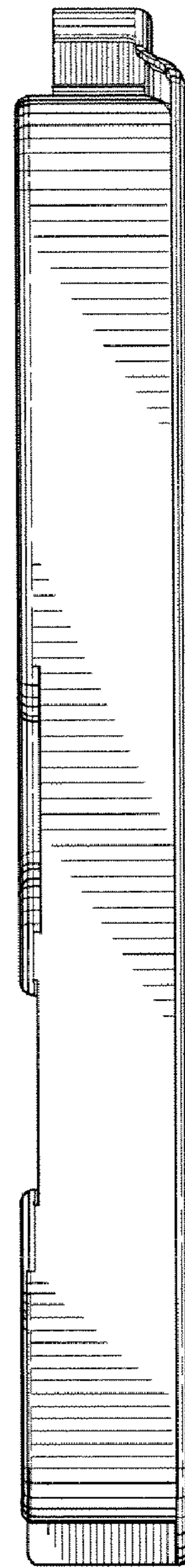

FIG. 7

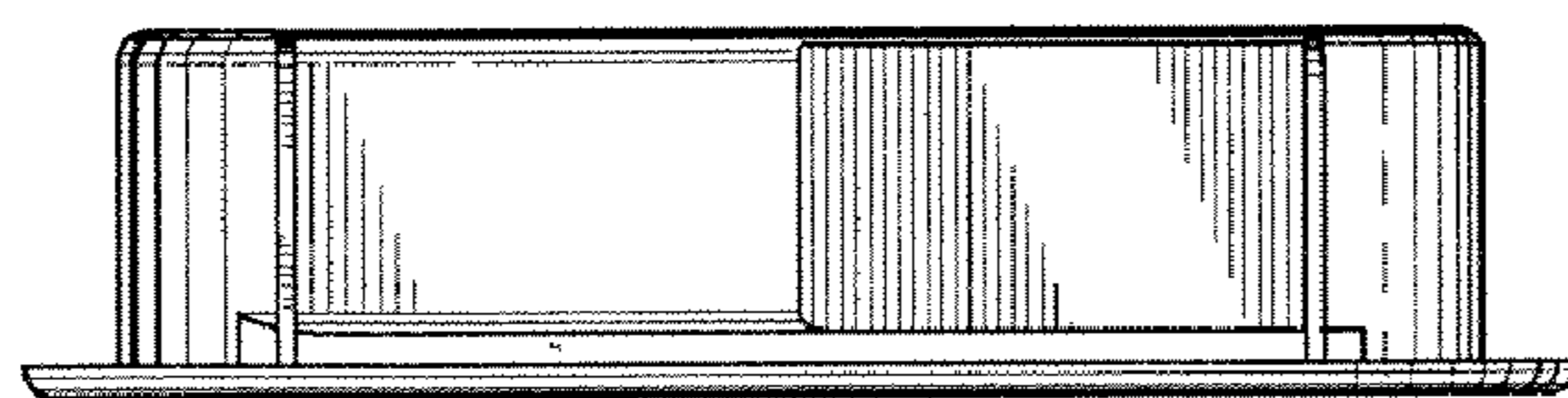

FIG. 8

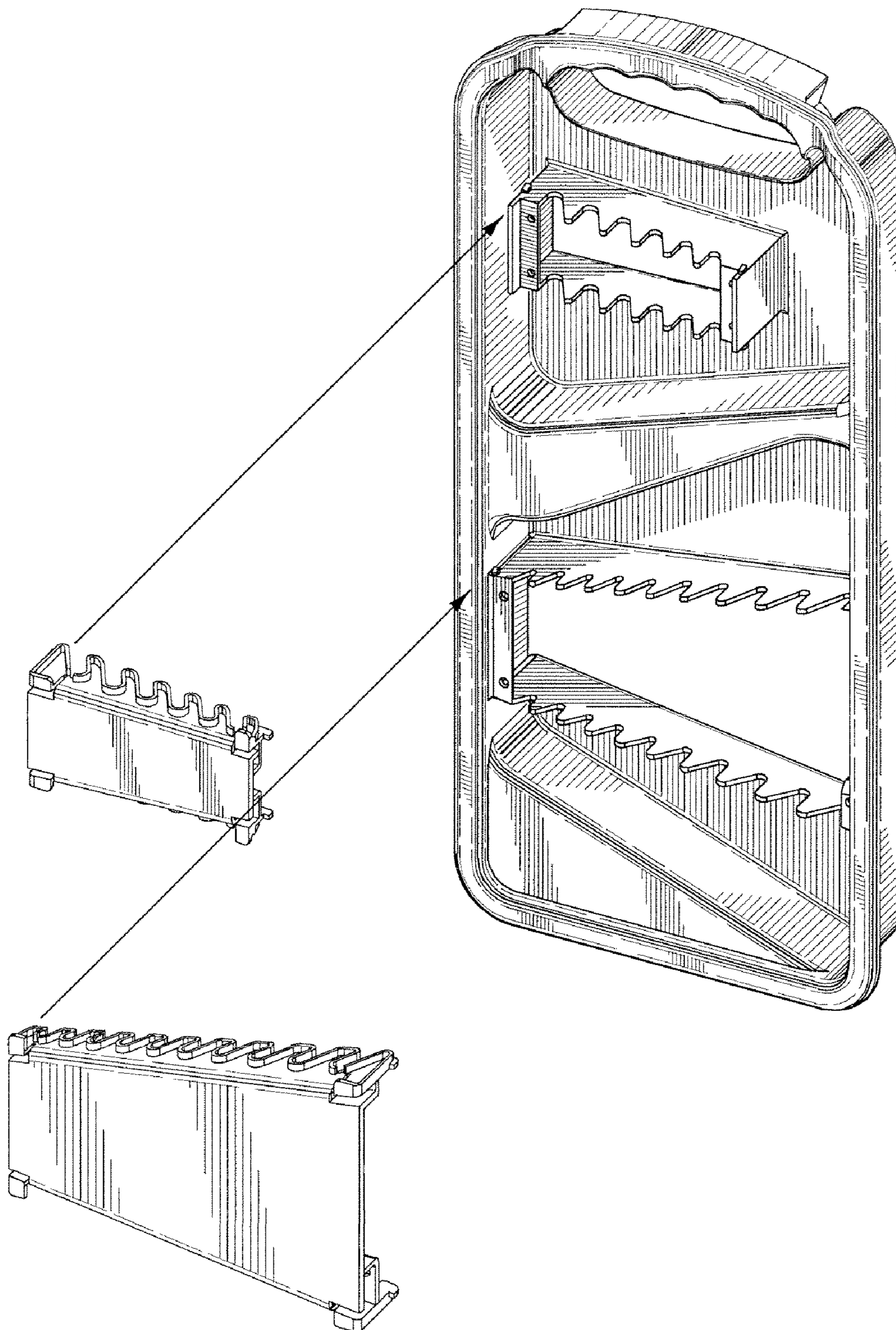

FIG. 9