



US00D551366S

(12) **United States Design Patent**
Galli

(10) **Patent No.:** **US D551,366 S**

(45) **Date of Patent:** **** Sep. 18, 2007**

(54) **FLASHLIGHT WITH FLARED HEAD**

(76) **Inventor:** **Robert D. Galli**, 126 Circuit Dr., North Kingstown, RI (US) 02852

(**) **Term:** **14 Years**

(21) **Appl. No.:** **29/226,506**

(22) **Filed:** **Mar. 29, 2005**

Related U.S. Application Data

(62) Division of application No. 29/219,248, filed on Dec. 14, 2004, now Pat. No. Des. 515,230.

(51) **LOC (8) Cl.** **26-02**

(52) **U.S. Cl.** **D26/37; D26/49**

(58) **Field of Classification Search** D26/37,
D26/40, 42, 46, 48, 49, 50; 362/157, 158,
362/171-174, 183, 184, 187, 190, 196, 199,
362/202, 203, 204, 205, 206, 208
See application file for complete search history.

(56) **References Cited**

U.S. PATENT DOCUMENTS

D303,578 S	*	9/1989	Gammache	D26/49
D333,527 S	*	2/1993	Leung	D26/49
D368,147 S	*	3/1996	Bamber et al.	D26/49
D396,314 S	*	7/1998	Chiu	D26/49
D434,164 S		11/2000	Galli	D26/49
D442,308 S	*	5/2001	Chiu	D26/49
D443,709 S	*	6/2001	Chiu	D26/49
D445,522 S	*	7/2001	Chiu	D26/49
D450,870 S	*	11/2001	Yang	D26/49
D455,510 S		4/2002	Galli	D26/37
D455,513 S		4/2002	Galli	D26/49
D463,593 S		9/2002	Galli	D26/49

D468,464 S		1/2003	Galli	D26/37
D468,851 S		1/2003	Galli	D26/37
D476,103 S		6/2003	Galli	D26/37
D481,816 S	*	11/2003	Sharrah et al.	D26/49
D489,469 S		5/2004	Liou	D26/37
D491,301 S		6/2004	Chen	D26/37
D492,432 S		6/2004	Yang	D26/37
D495,442 S		8/2004	Packard	D26/37
D501,054 S	*	1/2005	Galli	D26/37
D501,055 S		1/2005	Packard	
D515,230 S	*	2/2006	Galli	D26/49
D523,981 S	*	6/2006	Galli	D26/37

* cited by examiner

Primary Examiner—Ian Simmons

Assistant Examiner—Carissa C Fitts

(74) *Attorney, Agent, or Firm*—Barlow, Josephs & Holmes, Ltd.

(57) **CLAIM**

The ornamental design for a flashlight with a flared head, as shown and described.

DESCRIPTION

FIG. 1 is a perspective view of a flashlight with a flared head, showing my new design;

FIG. 2 is a top view thereof;

FIG. 3 is a bottom view thereof;

FIG. 4 is a right side view thereof;

FIG. 5 is left side view thereof;

FIG. 6 is front end, shown in an enlarged scale, view thereof; and,

FIG. 7 is rear end, shown in an enlarged scale, view thereof.

1 Claim, 7 Drawing Sheets

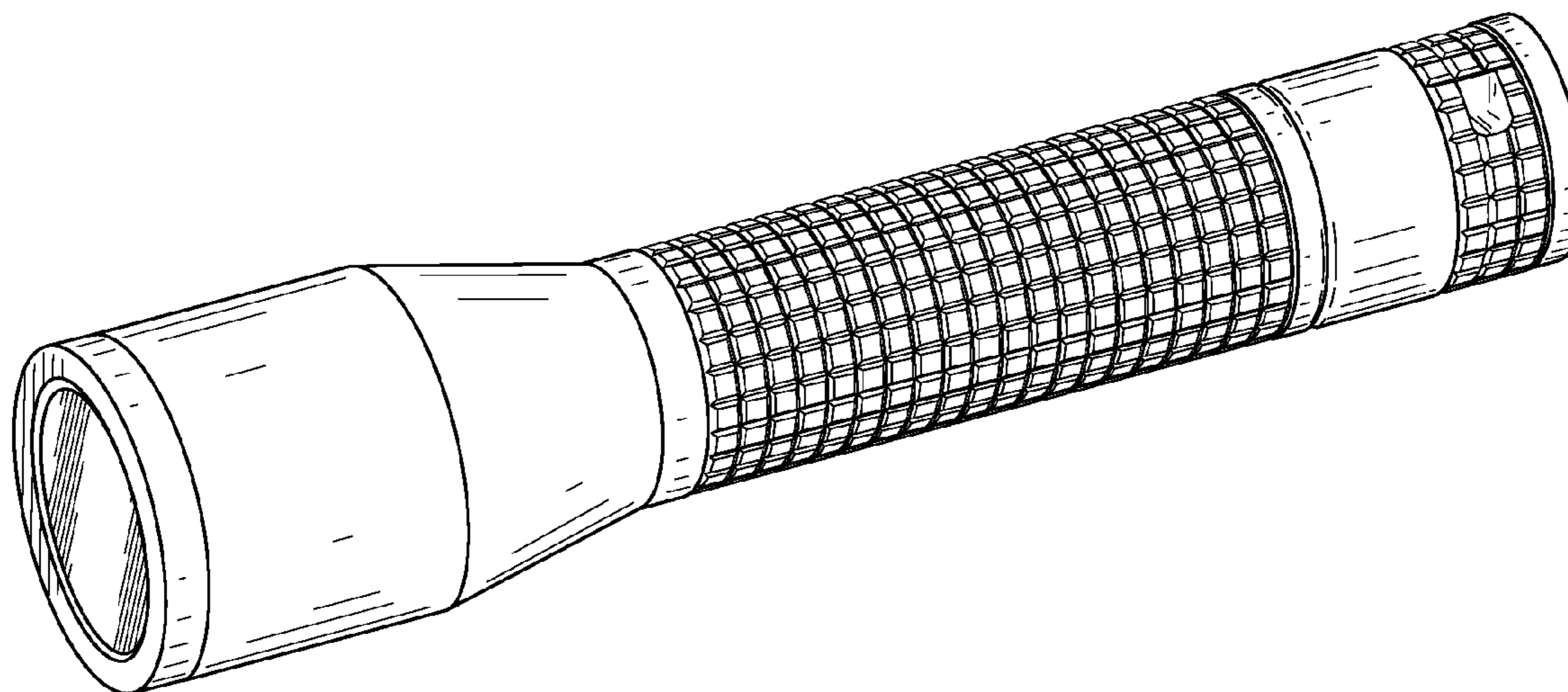

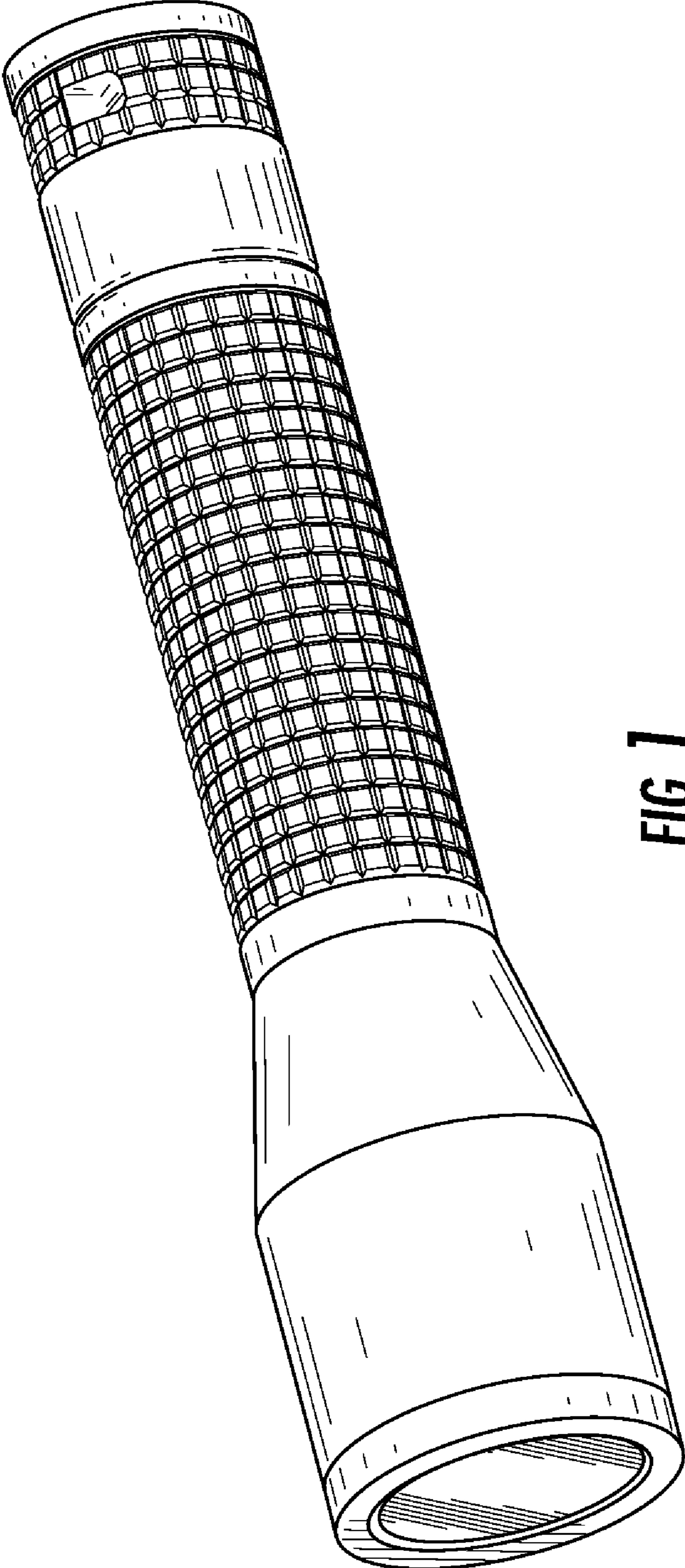

FIG. 1

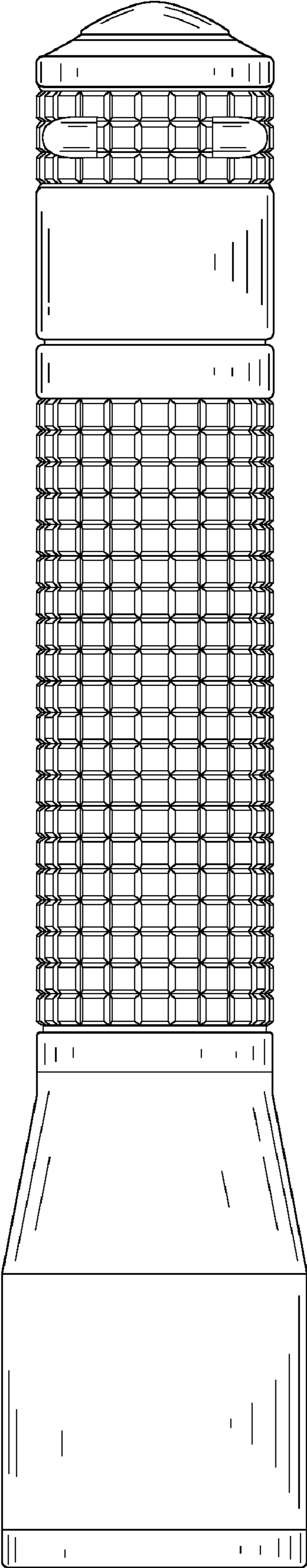

FIG. 2

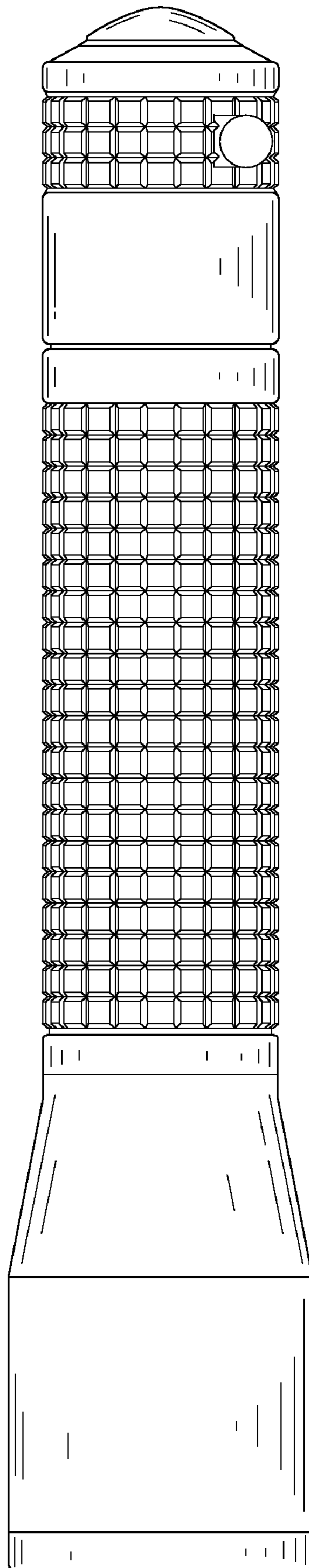

FIG. 4

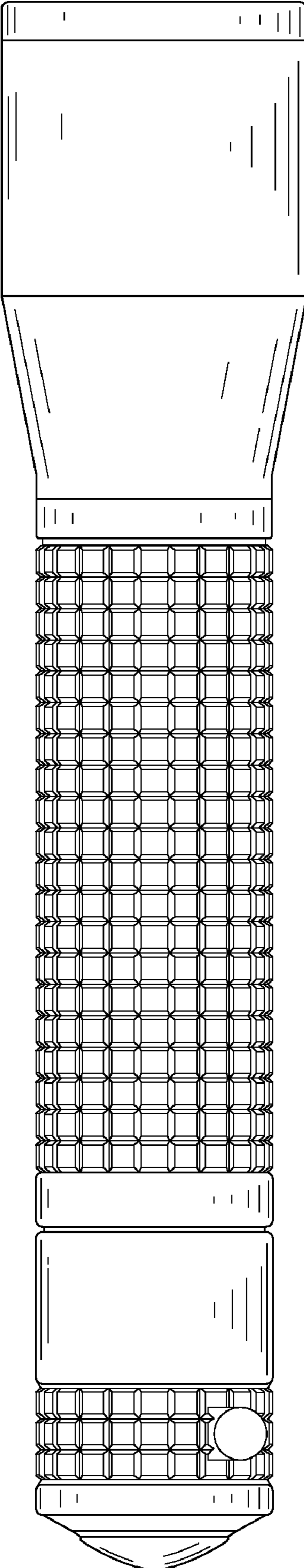

FIG. 5

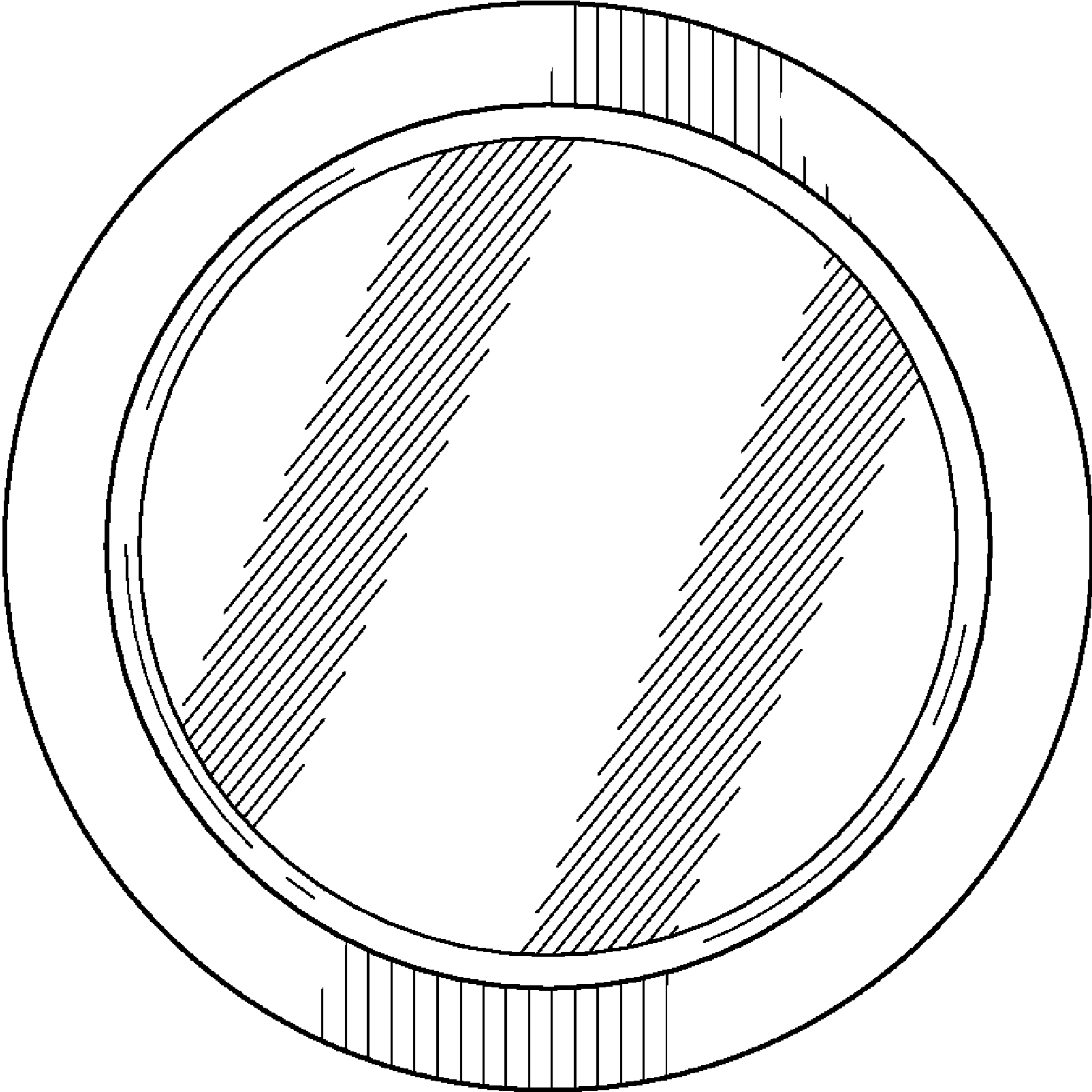

FIG. 6

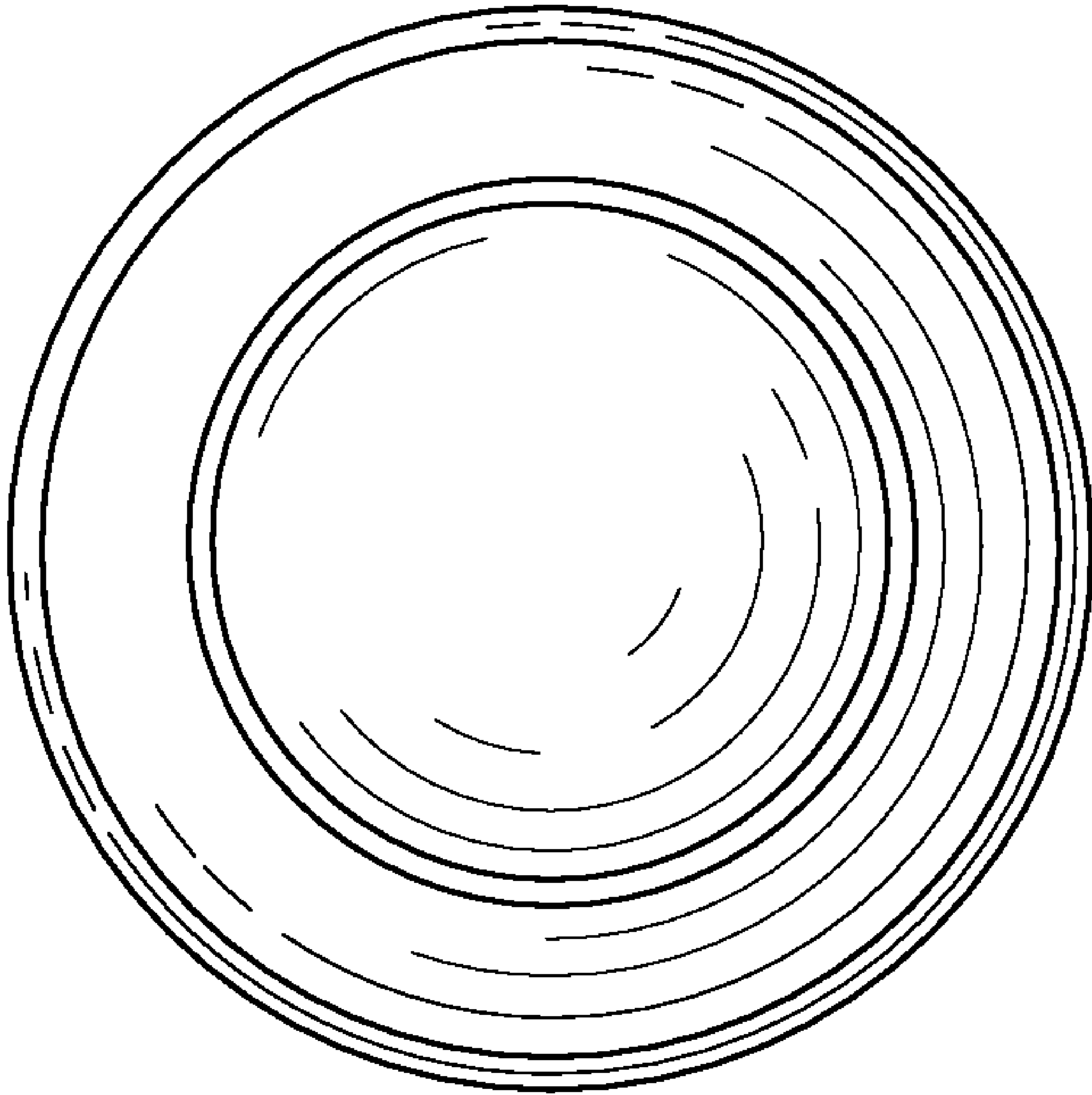

FIG. 7