



US00D551194S

(12) **United States Design Patent**
Kim et al.

(10) **Patent No.:** **US D551,194 S**
(45) **Date of Patent:** **** Sep. 18, 2007**

(54) **PROJECTION TELEVISION RECEIVER**

(75) Inventors: **Ji-Gwang Kim**, Seoul (KR); **Yun-Je Kang**, Seoul (KR)

(73) Assignee: **Samsung Electronics Co., Ltd.**,
Kyunggi-do (KR)

(**) Term: **14 Years**

(21) Appl. No.: **29/264,716**

(22) Filed: **Aug. 16, 2006**

(51) **LOC (8) Cl.** **14-03**

(52) **U.S. Cl.** **D14/128**

(58) **Field of Classification Search** D14/125–134,
D14/239, 371, 136, 374–377; 312/7.2; 348/836,
348/838, 180, 184, 325, 739; 341/12; 248/917–924,
248/465; 345/104, 133, 156, 168, 87, 173;
720/605, 669, 600, 655; 369/99, 197; 455/344–347
See application file for complete search history.

(56) **References Cited**

U.S. PATENT DOCUMENTS

D489,042 S	*	4/2004	Joe et al.	D14/126
D511,754 S	*	11/2005	Hirano	D14/128
D517,028 S	*	3/2006	Joe et al.	D14/128
D534,510 S	*	1/2007	Kang et al.	D14/128
D539,246 S	*	3/2007	Fujiki	D14/128
D541,776 S	*	5/2007	Senda et al.	D14/128

OTHER PUBLICATIONS

U.S. Appl. No. 29/217,926, Applicant: Young-Jun Kim, et al., filed Nov. 23, 2004 entitled Projection Television.
U.S. Appl. No. 29/228,022, Applicant: Yun-Je Kang, et al., filed Apr. 19, 2005 entitled Projection Television.
U.S. Appl. No. 29/228,026, Applicant: Yun-Je Kang, et al., filed Apr. 19, 2005 entitled Projection Television.
U.S. Appl. No. 29/231,241, Applicant: Young-Jun Kim, et al., filed Jun. 2, 2005 entitled Monitor.

U.S. Appl. No. 29/236,042, Applicant: Yun-Je Kang, et al., filed Aug. 10, 2005 entitled Projection Television.
U.S. Appl. No. 29/236,043, Applicant: Yun-Je Kang, et al., filed Aug. 10, 2005 entitled Projection Television.
U.S. Appl. No. 29/236,045, Applicant: Yun-Je Kang, et al., filed Aug. 10, 2005 entitled Projection Television.
U.S. Appl. No. 29/236,965, Applicant: Jun-Ho Yang, et al., filed Aug. 24, 2005 entitled Television.
U.S. Appl. No. 29/236,967, Applicant: Jun-Ho Yang, et al., filed Aug. 24, 2005 entitled Television.
U.S. Appl. No. 29/236,968, Applicant: Jun-Ho Yang, et al., filed Aug. 24, 2005 entitled Television.
U.S. Appl. No. 29/236,969, Applicant: Jun-Ho Yang, et al., filed Aug. 24, 2005 entitled Television.
U.S. Appl. No. 29/263,589, Applicant: Dong-Hee Won, et al., filed Jul. 26, 2006 entitled Television.
U.S. Appl. No. 29/263,581, Applicant: Don-Hee Won, et al., filed Jul. 26, 2006 entitled Projection Television.

* cited by examiner

Primary Examiner—Raphael Barkai
(74) *Attorney, Agent, or Firm*—Flynn, Thiel, Boutell & Tanis, P.C.

(57) **CLAIM**

The ornamental design for a projection television receiver, as shown and described.

DESCRIPTION

FIG. 1 is a top front perspective view of a projection television receiver showing our new design;
FIG. 2 is a front elevational view thereof;
FIG. 3 is a rear elevational view thereof;
FIG. 4 is a left side elevational view thereof;
FIG. 5 is a right side elevational view thereof;
FIG. 6 is a top plan view thereof; and,
FIG. 7 is a bottom plan view thereof.

1 Claim, 4 Drawing Sheets

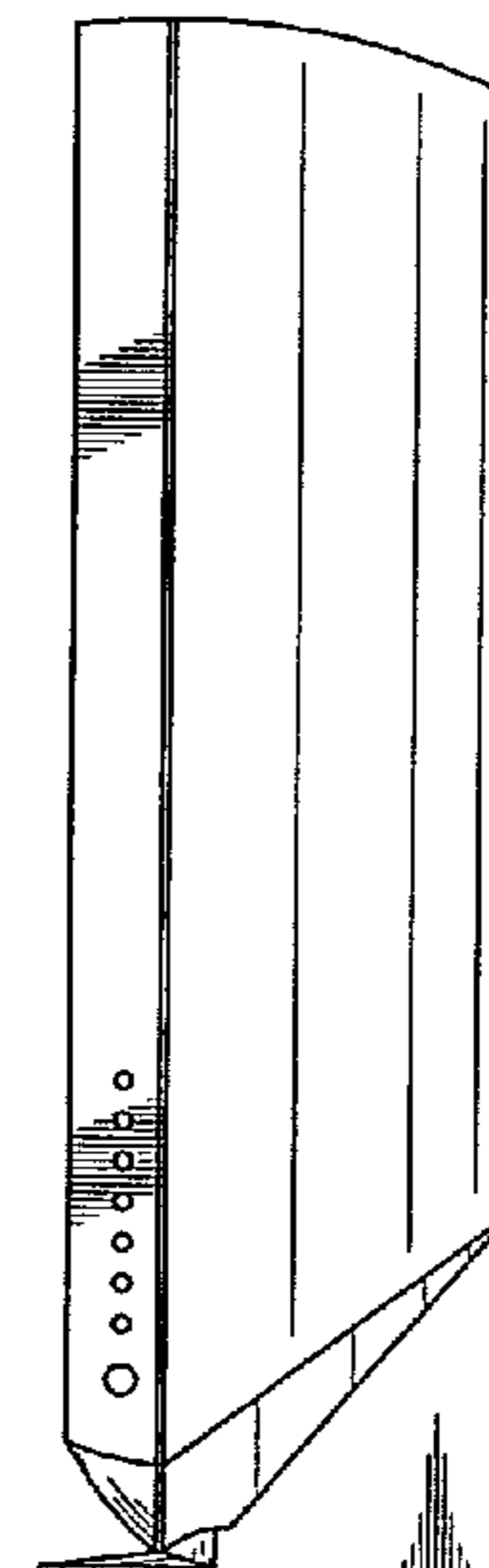
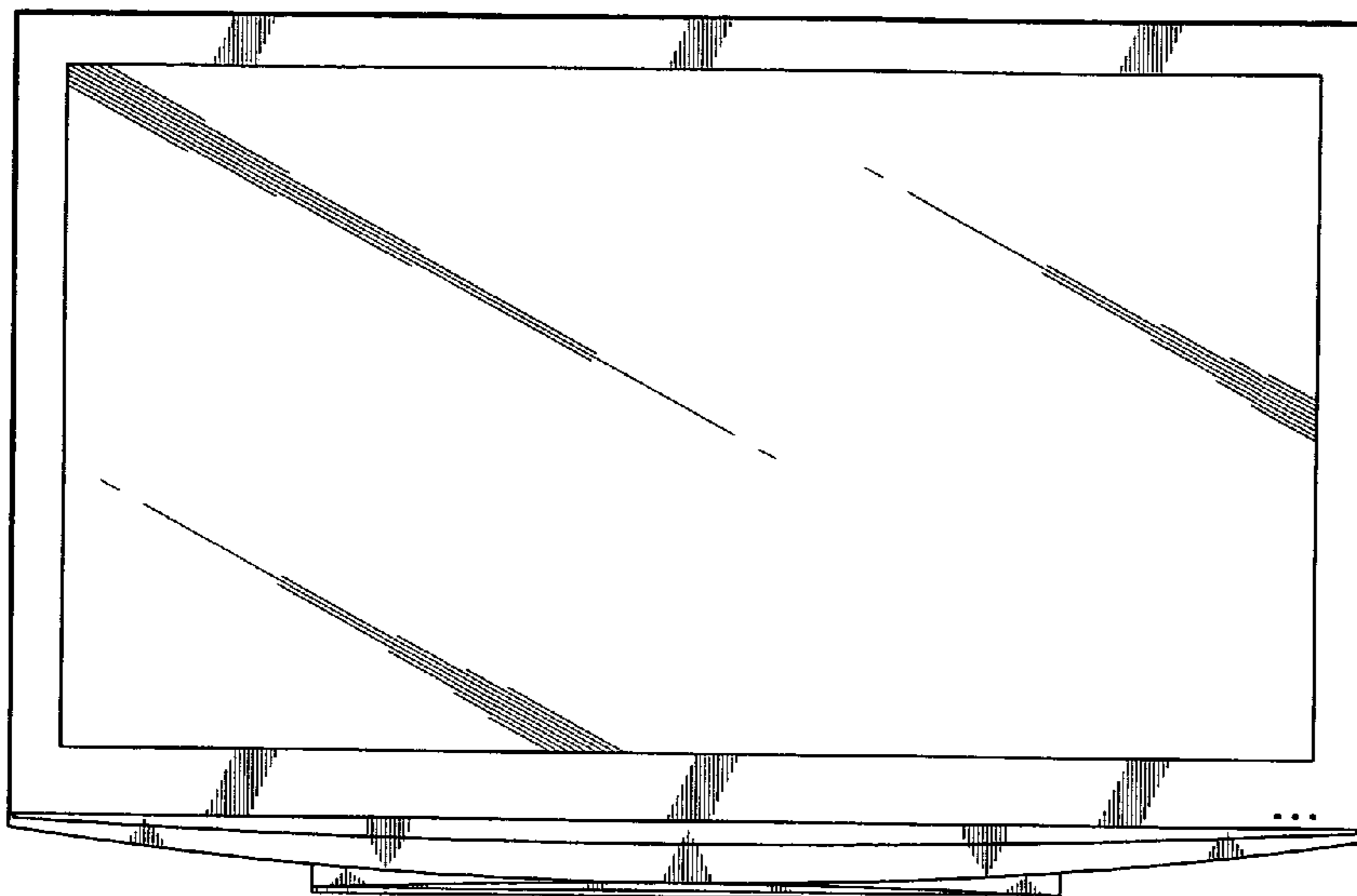

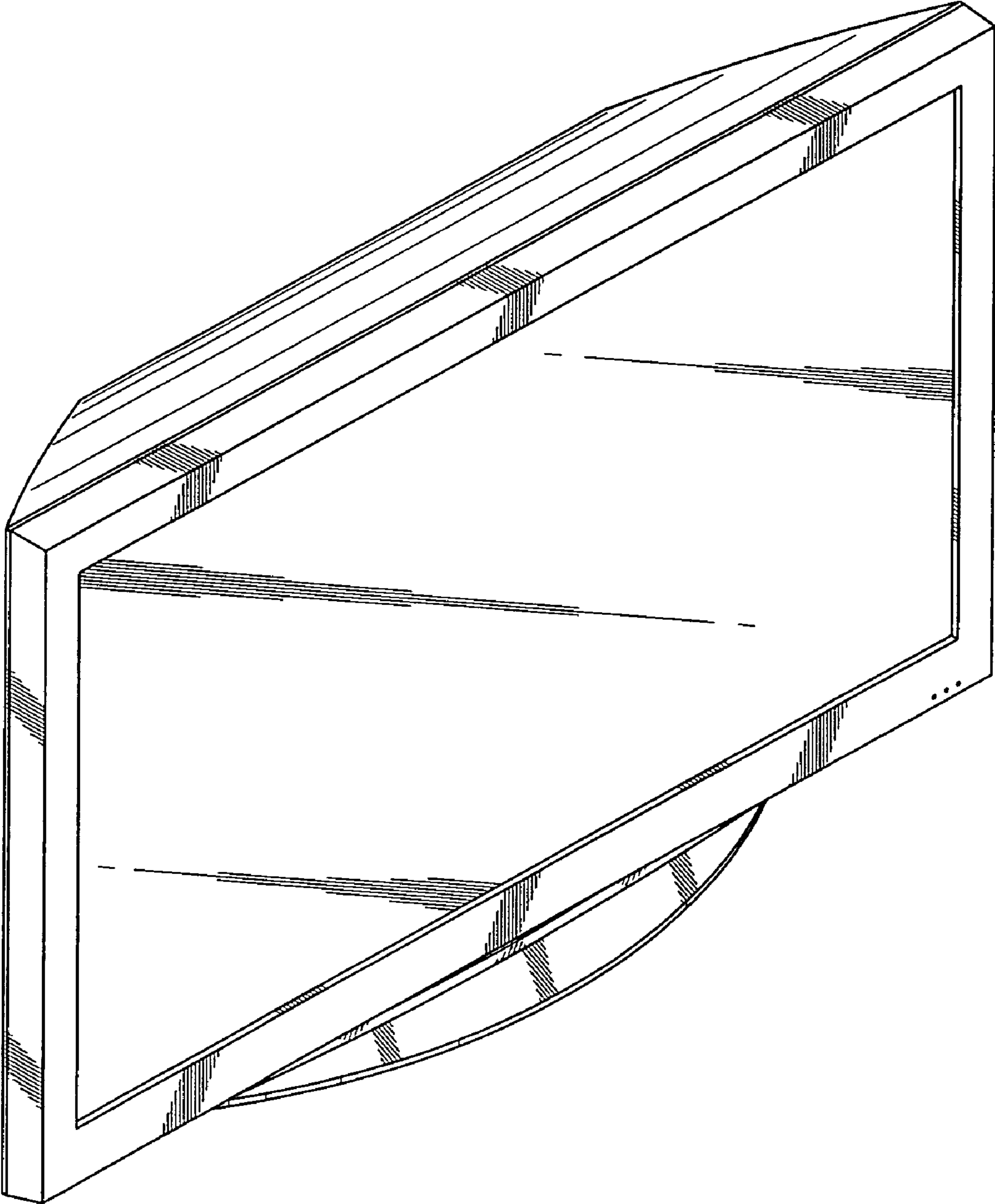

FIG. 1

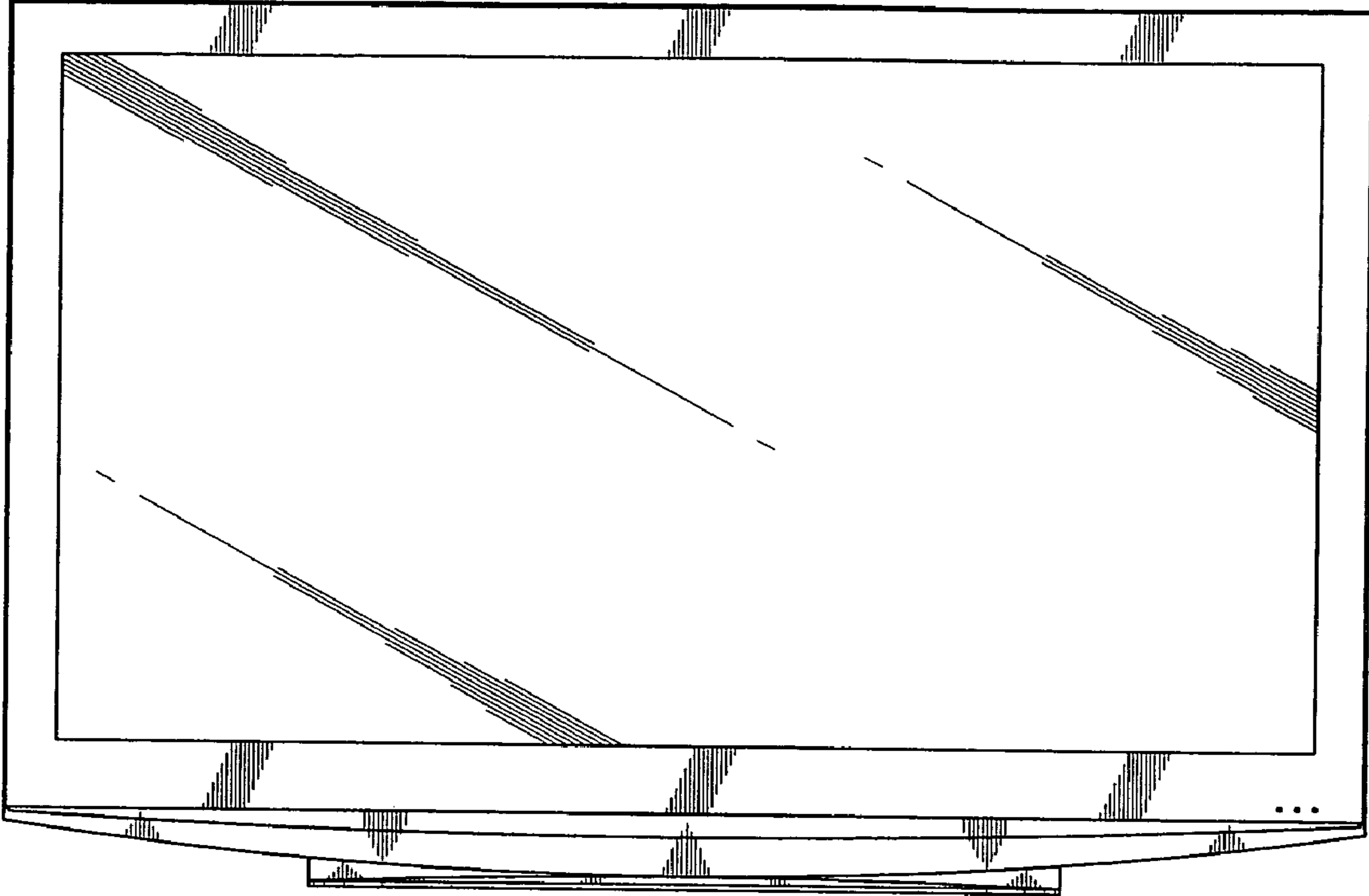

FIG. 2

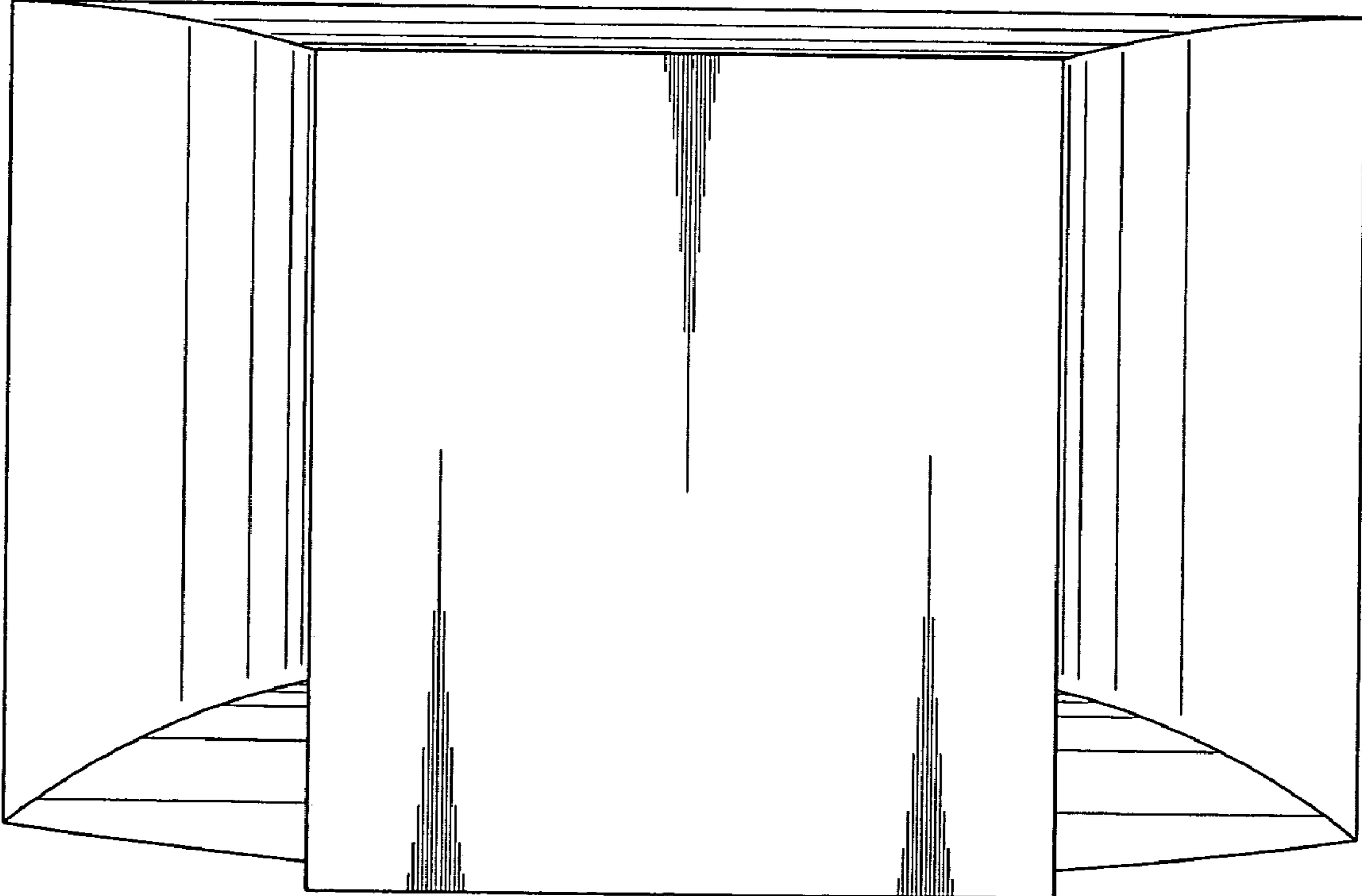

FIG. 3

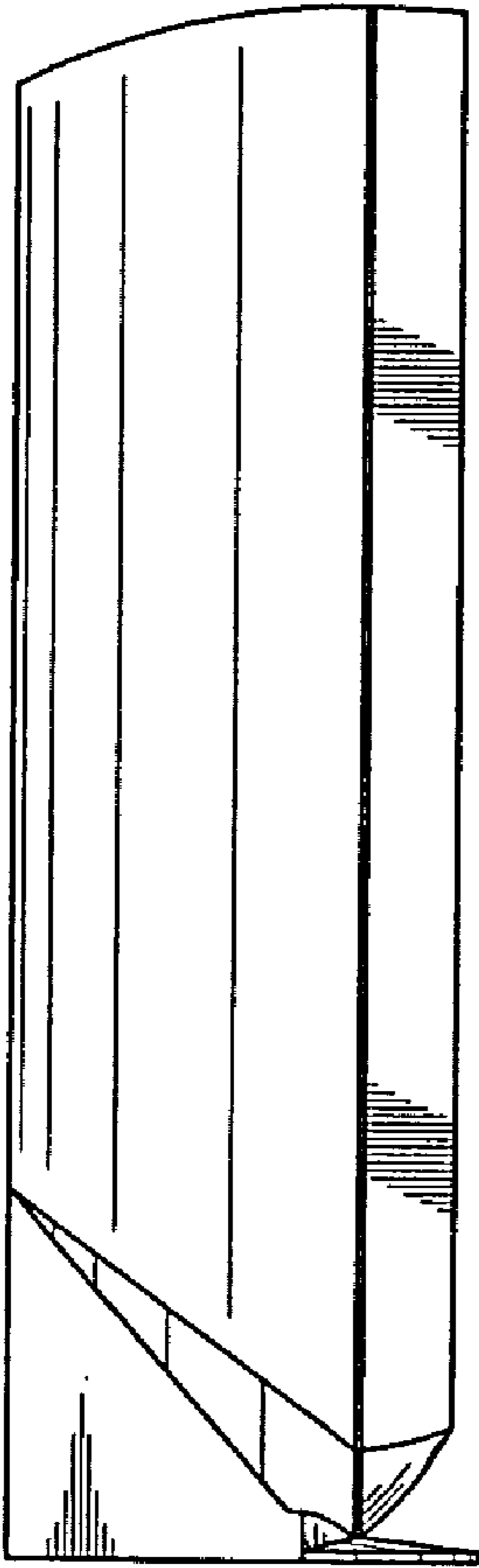

FIG. 4

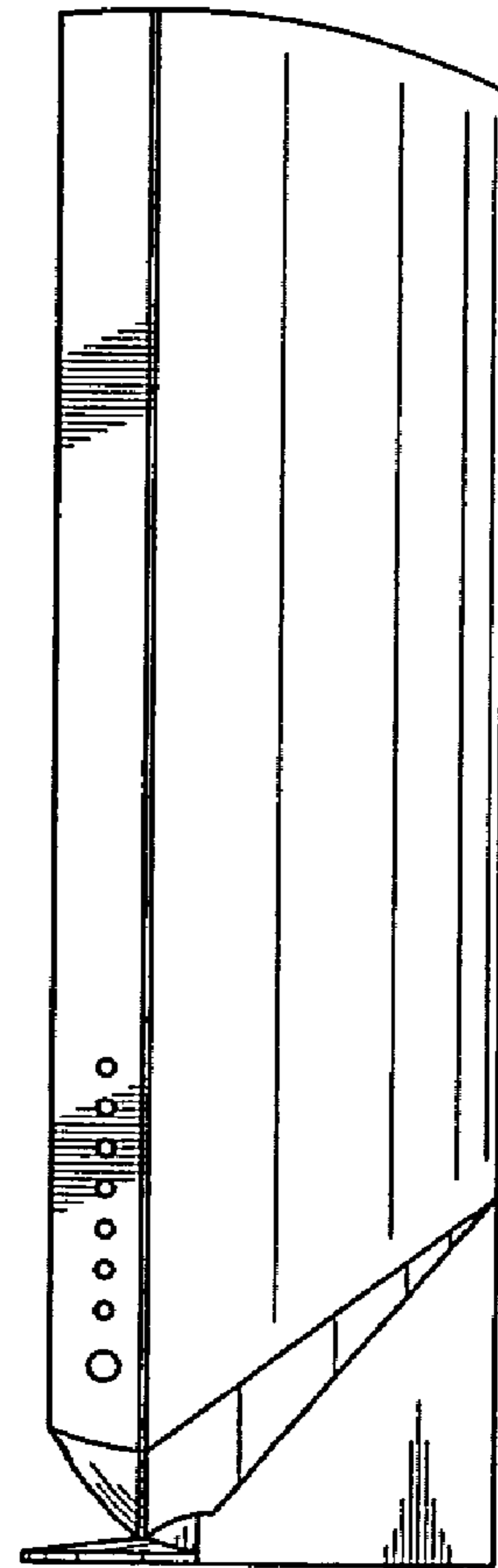

FIG. 5

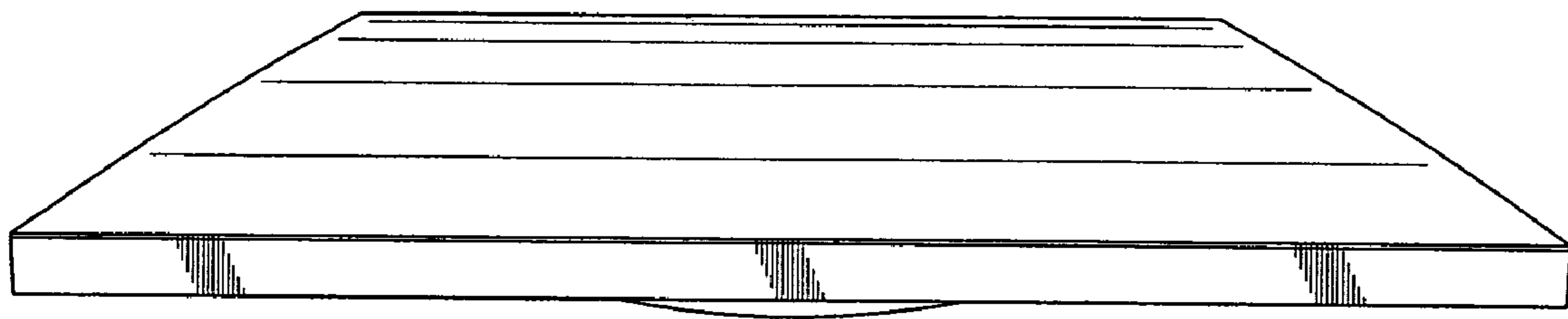

FIG. 6

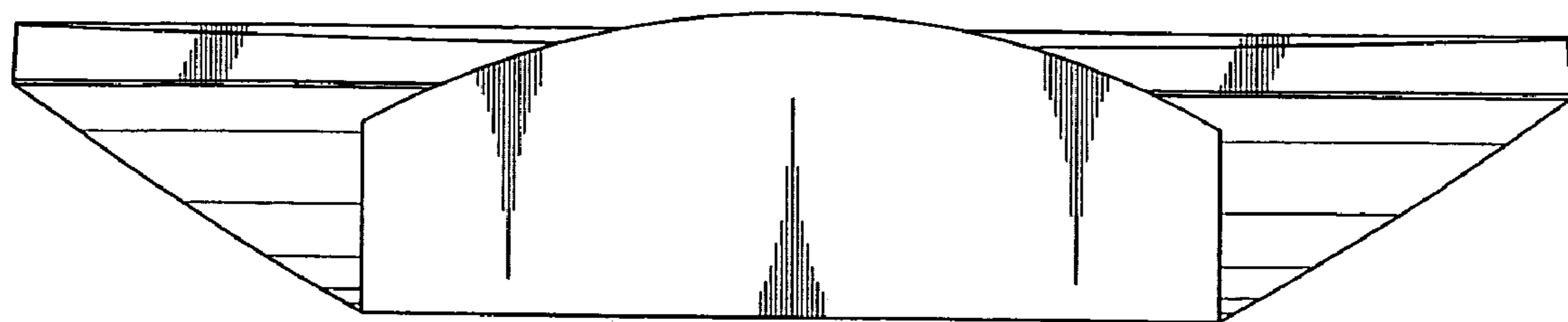

FIG. 7