

US00D551193S

(12) **United States Design Patent**
Ooshima et al.

(10) **Patent No.:** **US D551,193 S**
(45) **Date of Patent:** **** Sep. 18, 2007**

(54) **PROJECTION TELEVISION SET**

D534,883 S * 1/2007 Kang et al. D14/128

(75) Inventors: **Jun Ooshima**, Tokyo (JP); **Hiroshi Onoda**, Tokyo (JP)

FOREIGN PATENT DOCUMENTS

JP	946443	2/1996
JP	D1144171	6/2002
KR	30-0352551	5/2004
KR	30-0352556	5/2004

(73) Assignee: **Kabushiki Kaisha Toshiba** (JP)

(**) Term: **14 Years**

OTHER PUBLICATIONS

(21) Appl. No.: **29/253,257**

B&H Catalog, Home Entertainment, Summer 2004, pp. 120-122.

(22) Filed: **Feb. 3, 2006**

* cited by examiner

(51) **LOC (8) Cl.** **14-03**

Primary Examiner—Philip S. Hyder

(52) **U.S. Cl.** **D14/128**

(74) *Attorney, Agent, or Firm*—Banner & Witcoff, Ltd.

(58) **Field of Classification Search** D14/125,
D14/126, 127, 128, 129, 133, 134, 374, 375,
D14/376; 348/836, 838, 180, 184, 325, 739;
248/917-924; 345/104, 133, 156, 168, 87,
345/173; 341/12; D6/477, 479

(57) **CLAIM**

See application file for complete search history.

The ornamental design for a projection television set, as shown and described.

DESCRIPTION

(56) **References Cited**

FIG. 1 is a front, top and right side perspective view of a projection television set, showing our new design;

U.S. PATENT DOCUMENTS

FIG. 2 is a front elevational view thereof;

D486,803 S	*	2/2004	Fujiki et al.	D14/126
D489,042 S	*	4/2004	Joe et al.	D14/126
D510,568 S	*	10/2005	Joe et al.	D14/128
D511,753 S	*	11/2005	Joe et al.	D14/128
D512,032 S	*	11/2005	Joe et al.	D14/128
D512,388 S	*	12/2005	Hayakawa	D14/128
D512,389 S	*	12/2005	Joe et al.	D14/128
D532,764 S	*	11/2006	Kim et al.	D14/128
D534,141 S	*	12/2006	Onoda et al.	D14/128

FIG. 3 is a rear elevational view thereof;

FIG. 4 is a top plan view thereof;

FIG. 5 is a bottom plan view thereof;

FIG. 6 is a left side elevational view thereof; and,

FIG. 7 is a right side elevational view thereof.

1 Claim, 3 Drawing Sheets

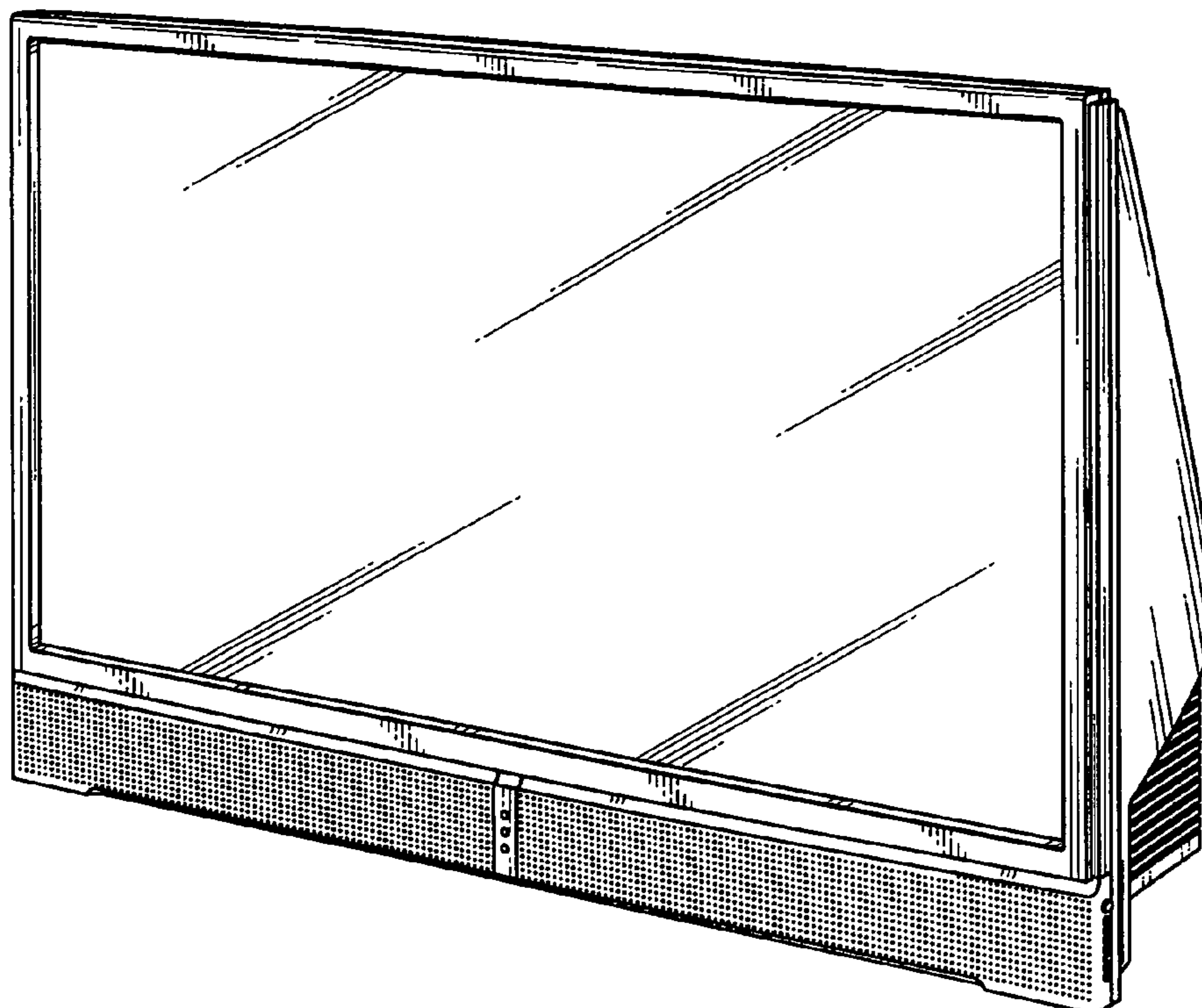

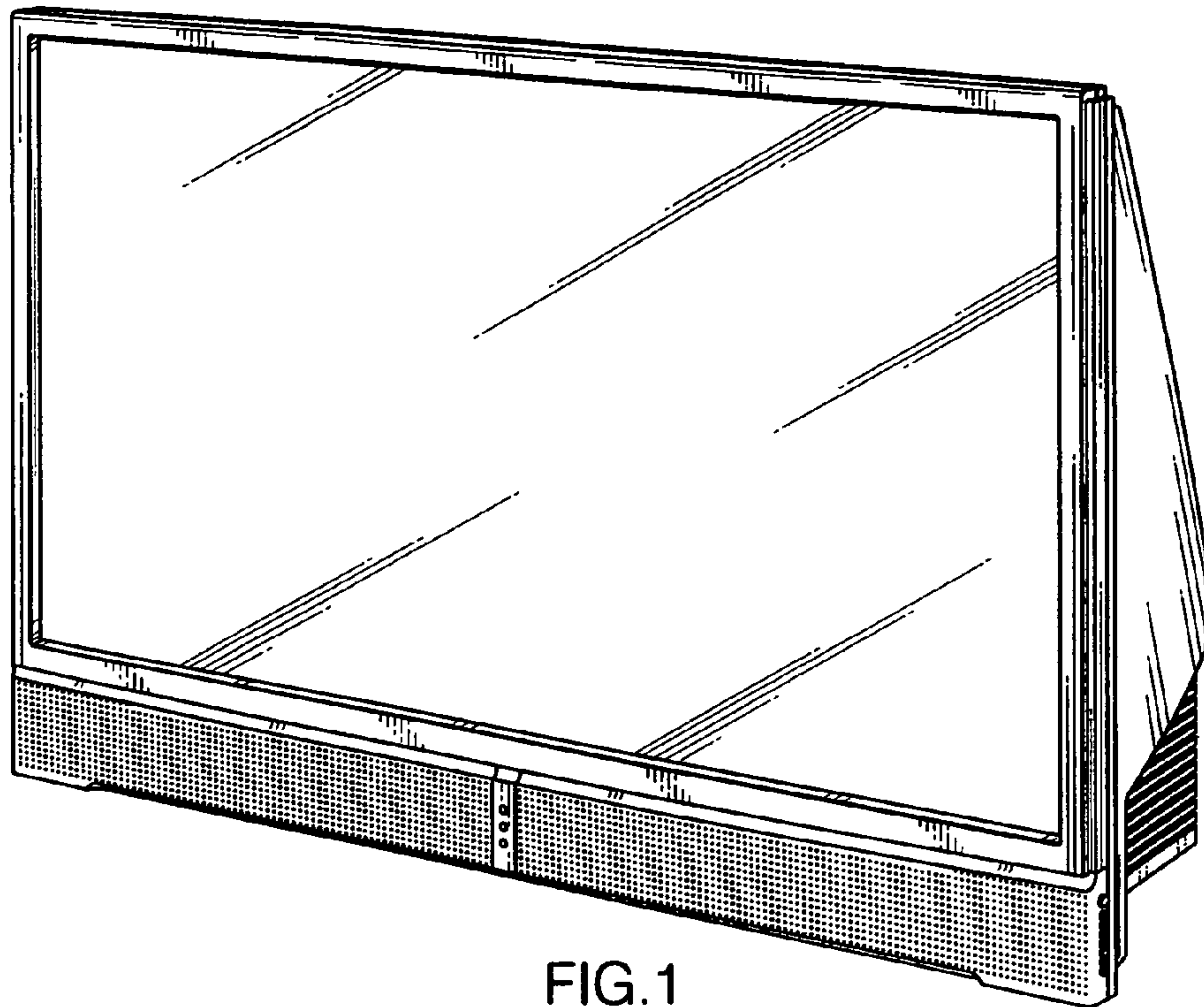

FIG. 1

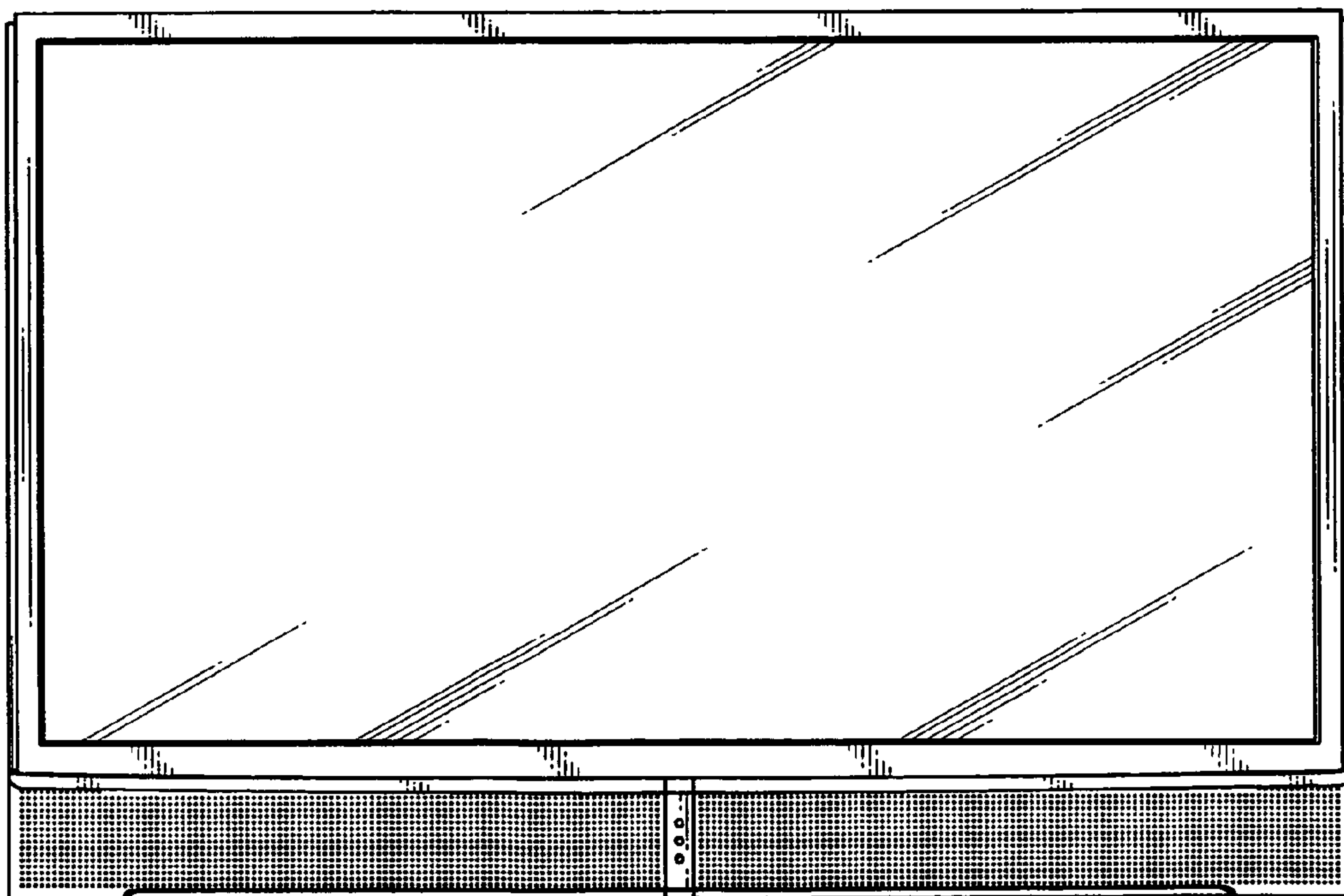

FIG. 2

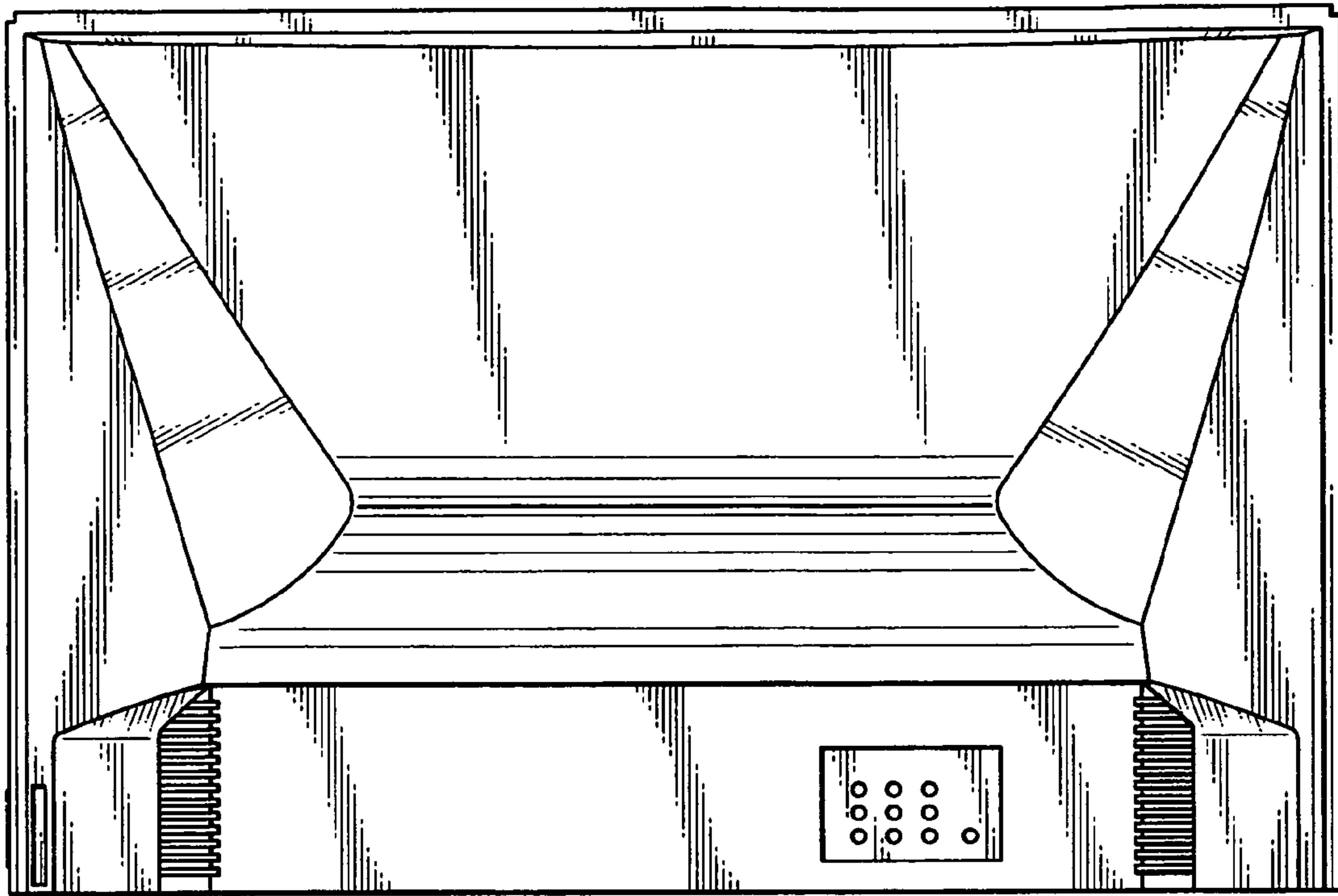

FIG. 3

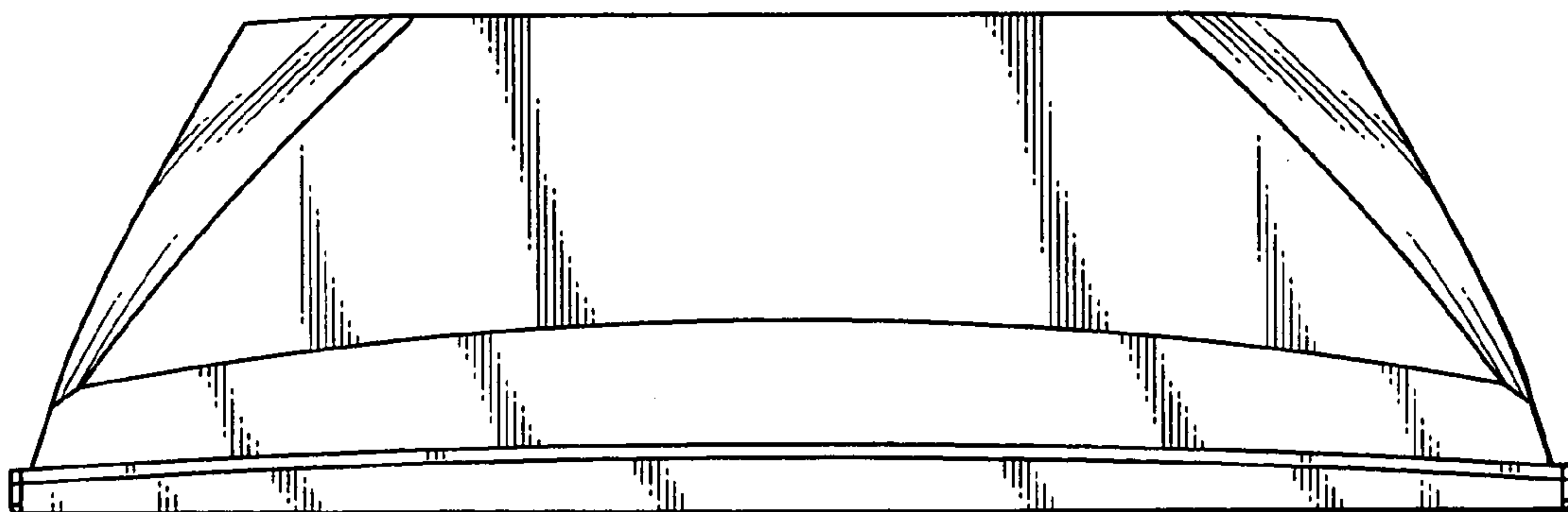

FIG. 4

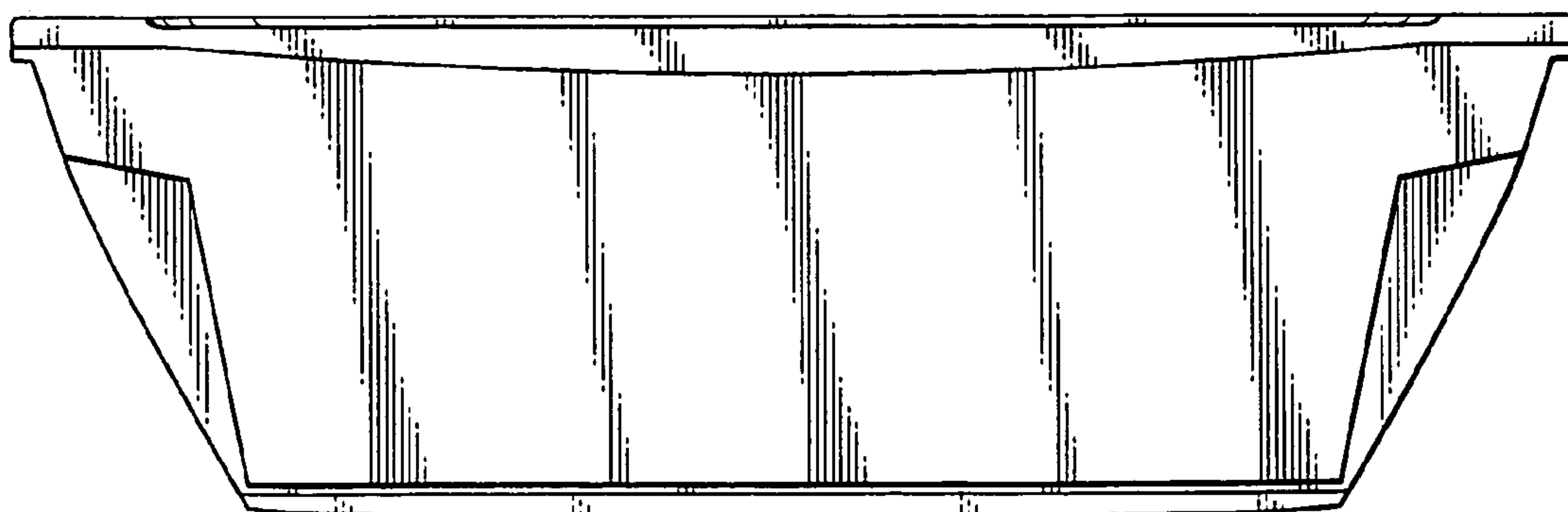

FIG. 5

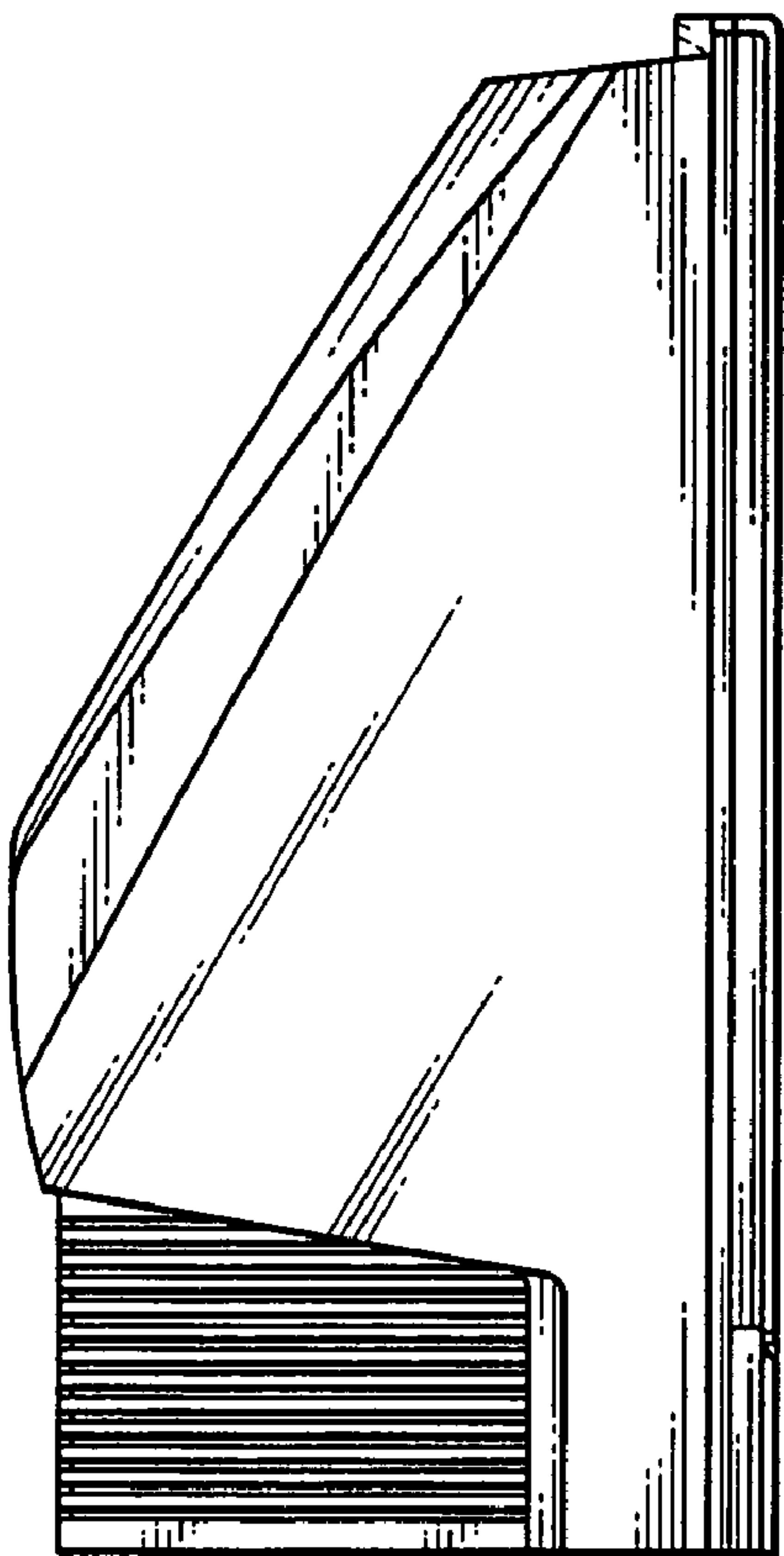

FIG. 6

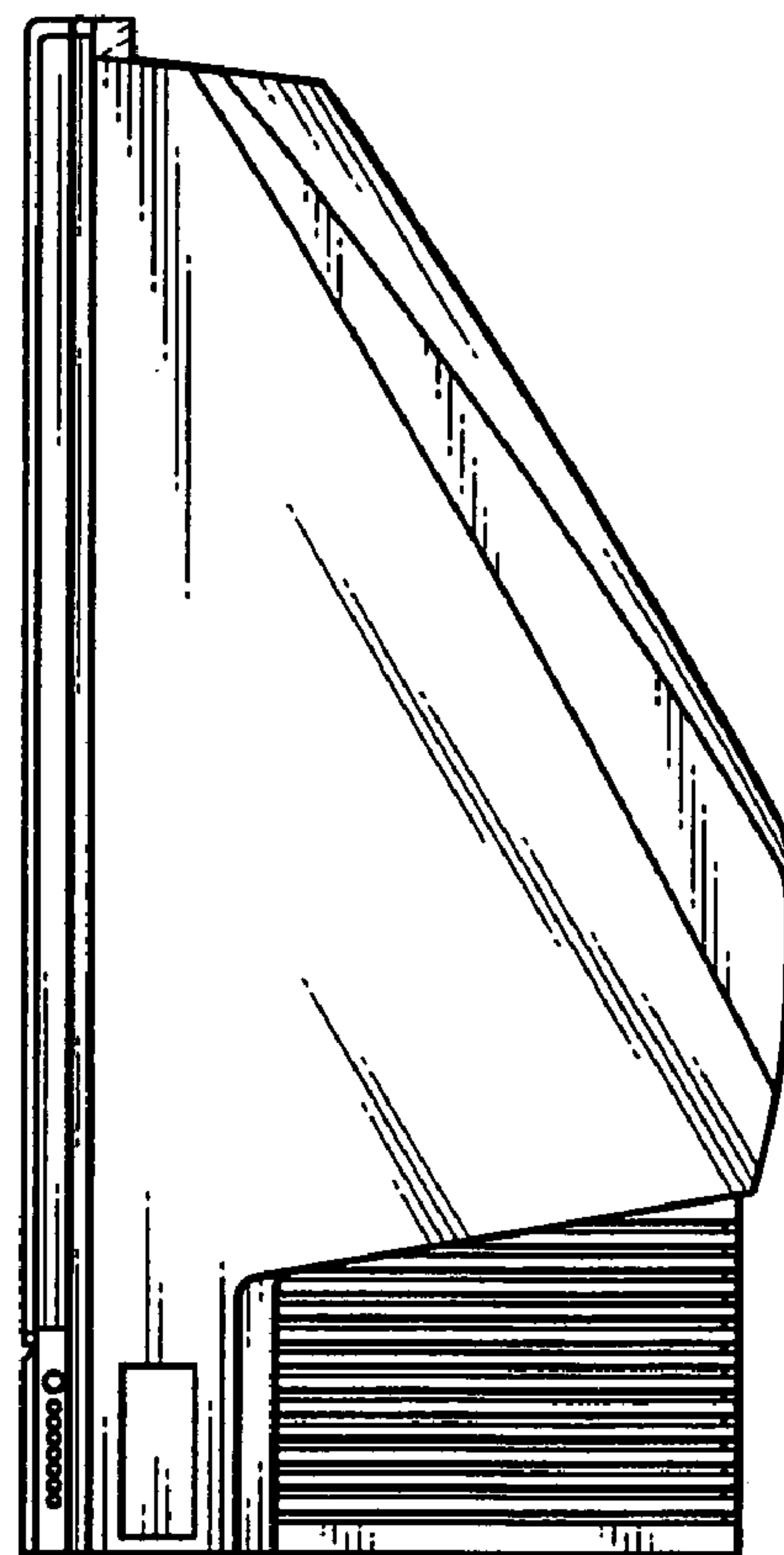

FIG. 7