

US00D551187S

(12) **United States Design Patent**
Kita

(10) **Patent No.:** **US D551,187 S**

(45) **Date of Patent:** **** Sep. 18, 2007**

(54) **TELEVISION SET**

(75) Inventor: **Toshiyuki Kita**, Osaka (JP)

(73) Assignee: **Sharp Kabushiki Kaisha**, Osaka (JP)

(**) Term: **14 Years**

(21) Appl. No.: **29/243,704**

(22) Filed: **Nov. 30, 2005**

(30) **Foreign Application Priority Data**

May 31, 2005 (JP) 2005-015607

(51) **LOC (8) Cl.** **14-03**

(52) **U.S. Cl.** **D14/126**

(58) **Field of Classification Search** D14/125-134,
D14/239, 371, 136, 374-377; 312/7.2; 348/836,
348/838, 180, 184, 325, 739; 341/12; 248/917-924,
248/465; 345/104, 133, 156, 168, 87, 173;
720/605, 669, 600, 655; 369/99, 197; 455/344-347
See application file for complete search history.

(56) **References Cited**

U.S. PATENT DOCUMENTS

D337,113 S	7/1993	Saito
D342,497 S	12/1993	Saito et al.
D342,501 S	12/1993	Saeki et al.
D351,155 S	10/1994	Usami et al.
D351,156 S	10/1994	Usami et al.
D357,244 S	4/1995	Usami et al.
D357,245 S	4/1995	Usami et al.
D357,472 S	4/1995	Usami et al.
D369,596 S	5/1996	Akiyama et al.
D372,026 S	7/1996	Akiyama et al.
D373,583 S	9/1996	Akiyama et al.
D427,169 S	6/2000	Saeki et al.
D429,227 S	8/2000	Shimizu
D431,537 S	10/2000	Saeki et al.
D438,848 S	3/2001	Kita
D439,224 S	3/2001	Kita
D439,225 S	3/2001	Kita
D453,747 S	2/2002	Kita
D453,748 S	2/2002	Kita
D456,370 S	4/2002	Kita

D458,910 S	6/2002	Kita
D462,353 S	9/2002	Kita
D472,532 S	* 4/2003	Niitsu D14/126
D483,020 S	* 12/2003	Nagao et al. D14/126
D492,269 S	6/2004	Kita
D496,915 S	10/2004	Kita
D497,351 S	10/2004	Kita
D497,599 S	10/2004	Kita
D499,076 S	11/2004	Kita
D501,186 S	1/2005	Kita
D501,654 S	2/2005	Kita
D502,451 S	3/2005	Kita
D502,931 S	3/2005	Kita
D505,123 S	5/2005	Kita
D505,403 S	5/2005	Kita
D510,731 S	10/2005	Kita
D512,385 S	12/2005	Kita
D512,386 S	12/2005	Kita
D512,387 S	12/2005	Kita

OTHER PUBLICATIONS

U.S. Appl. No. 29/228,974, filed May 2, 2005, Fuji et al., entitled, "Television Set," pending.

(Continued)

Primary Examiner—Raphael Barkai
(74) *Attorney, Agent, or Firm*—Nixon & Vanderhye, PC

(57) **CLAIM**

The ornamental design for a "television set," as shown and described.

DESCRIPTION

FIG. 1 is a top, front and right side perspective view of a television set according to my design;
FIG. 2 is a front elevational view thereof;
FIG. 3 is a rear elevational view thereof;
FIG. 4 is a top plan view thereof;
FIG. 5 is a bottom plan view thereof;
FIG. 6 is a right side elevational view thereof; and,
FIG. 7 is a left side elevational view thereof.

1 Claim, 5 Drawing Sheets

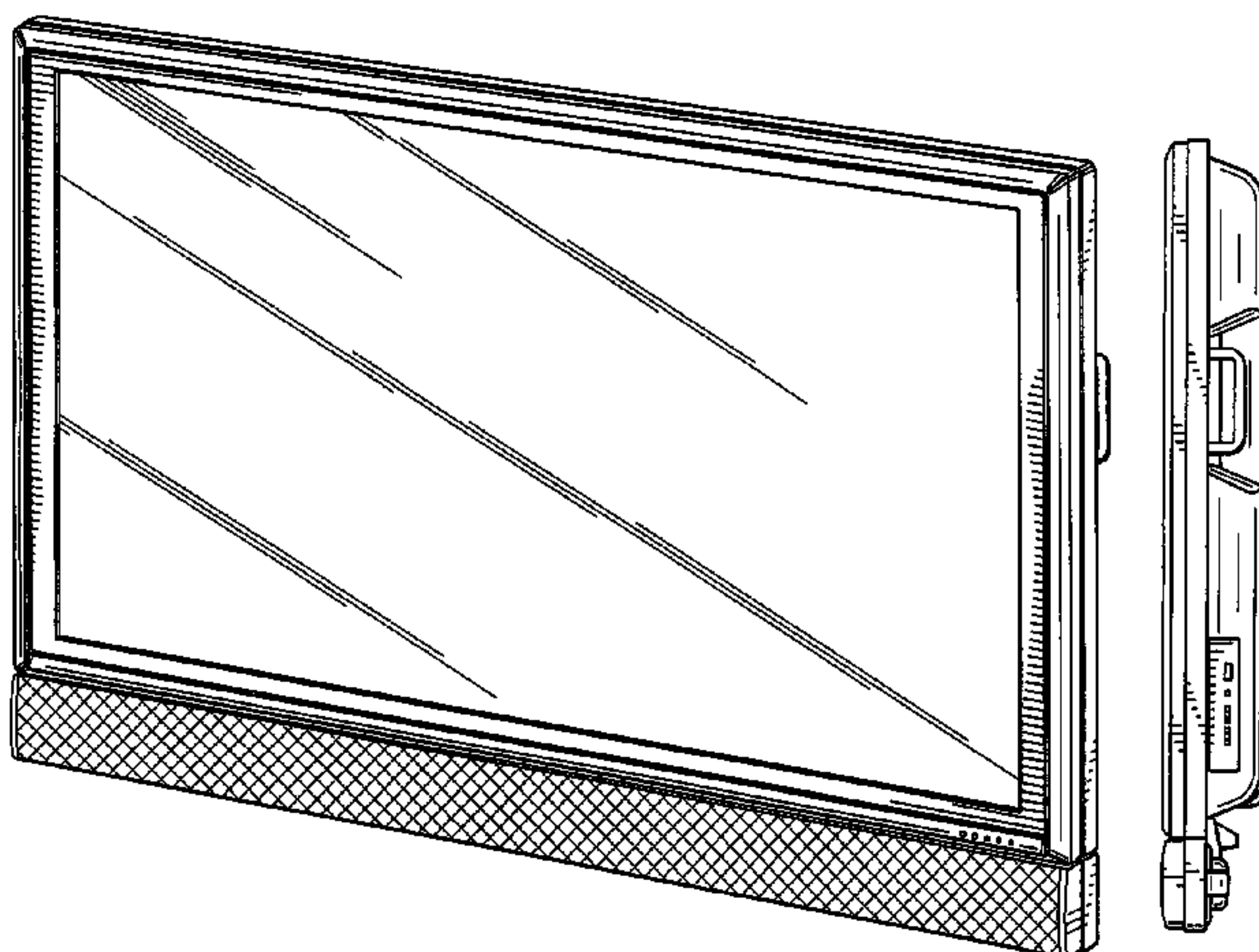

OTHER PUBLICATIONS

U.S. Appl. No. 29/229,686, filed May 11, 2005, Kita, entitled, "Television Set," pending.
U.S. Appl. No. 29/228,975, filed May 2, 2005, Fuji et al., entitled, "Television Set," pending.
U.S. Appl. No. 29/232,697, filed Jun. 23, 2005, Kita, entitled, "Television Set," pending.
U.S. Appl. No. 29/232,616, filed Jun. 22, 2005, Kita, entitled, "Television Set," pending.
U.S. Appl. No. 29/243,703, filed Nov. 30, 2005, Kita, entitled, "Television Set," pending.
U.S. Appl. No. 29/243,707, filed Nov. 30, 2005, Kita, entitled, "Television Set," pending.
U.S. Appl. No. 29/245,015, filed Dec. 19, 2005, Kita, entitled, "Television Set," pending.
U.S. Appl. No. 29/253,456, filed Feb. 8, 2006, Kita, entitled, "Television Set," pending.
U.S. Appl. No. 29/253,455, filed Feb. 8, 2006, Kita, entitled, "Television Set," pending.

U.S. Appl. No. 29/243,705, filed Nov. 30, 2005, Kita, entitled, "Externally Exposed Surfaces Of A Speaker For A Television Set," pending.
U.S. Appl. No. 29/245,754, filed Dec. 29, 2005, Totsuka, entitled, "Television Set," pending.
U.S. Appl. No. 29/243,346, filed Nov. 2005, Kita.
U.S. Appl. No. 29/243,347, filed Nov. 2005, Kita.
U.S. Appl. No. 29/243,348, filed Nov. 2005, Kita.
U.S. Appl. No. 29/243,350, filed Nov. 2005, Kita.
U.S. Appl. No. 29/232,622, filed Jun. 22, 2005, Kita.
U.S. Appl. No. 29/232,620, filed Jun. 22, 2005, Kita.
U.S. Appl. No. 29/232,607, filed Jun. 22, 2005, Kita.
U.S. Appl. No. 29/232,621, filed Jun. 22, 2005, Kita.
U.S. Appl. No. 29/232,614, filed Jun. 22, 2005, Kita.
U.S. Appl. No. 29/207,659, filed Jun. 2004, Kita.
U.S. Appl. No. 29/207,660, filed Jun. 2004, Kita.
U.S. Appl. No. 29/206,962, filed Jun. 2004, Kita.

* cited by examiner

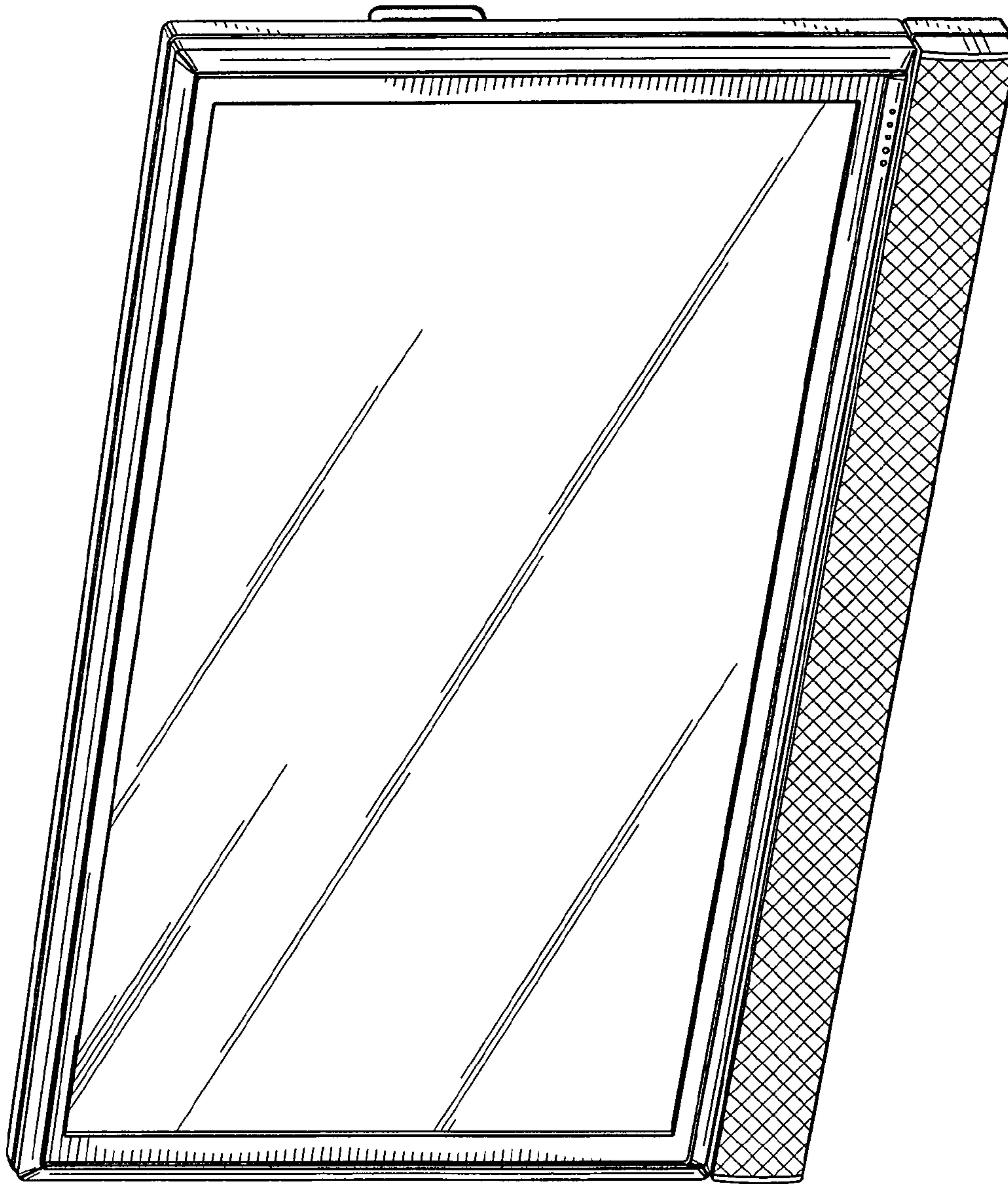

Fig. 1

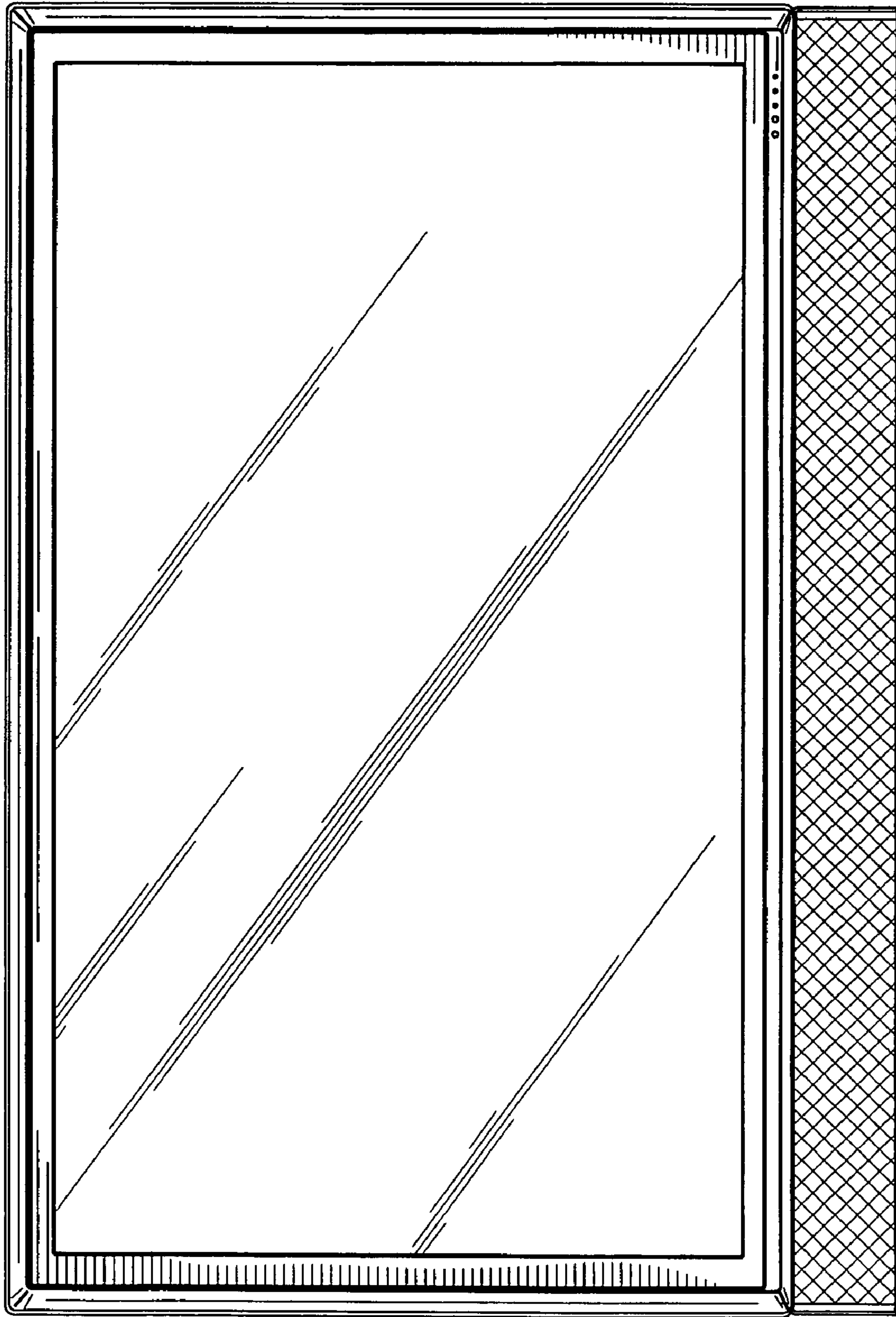

Fig. 2

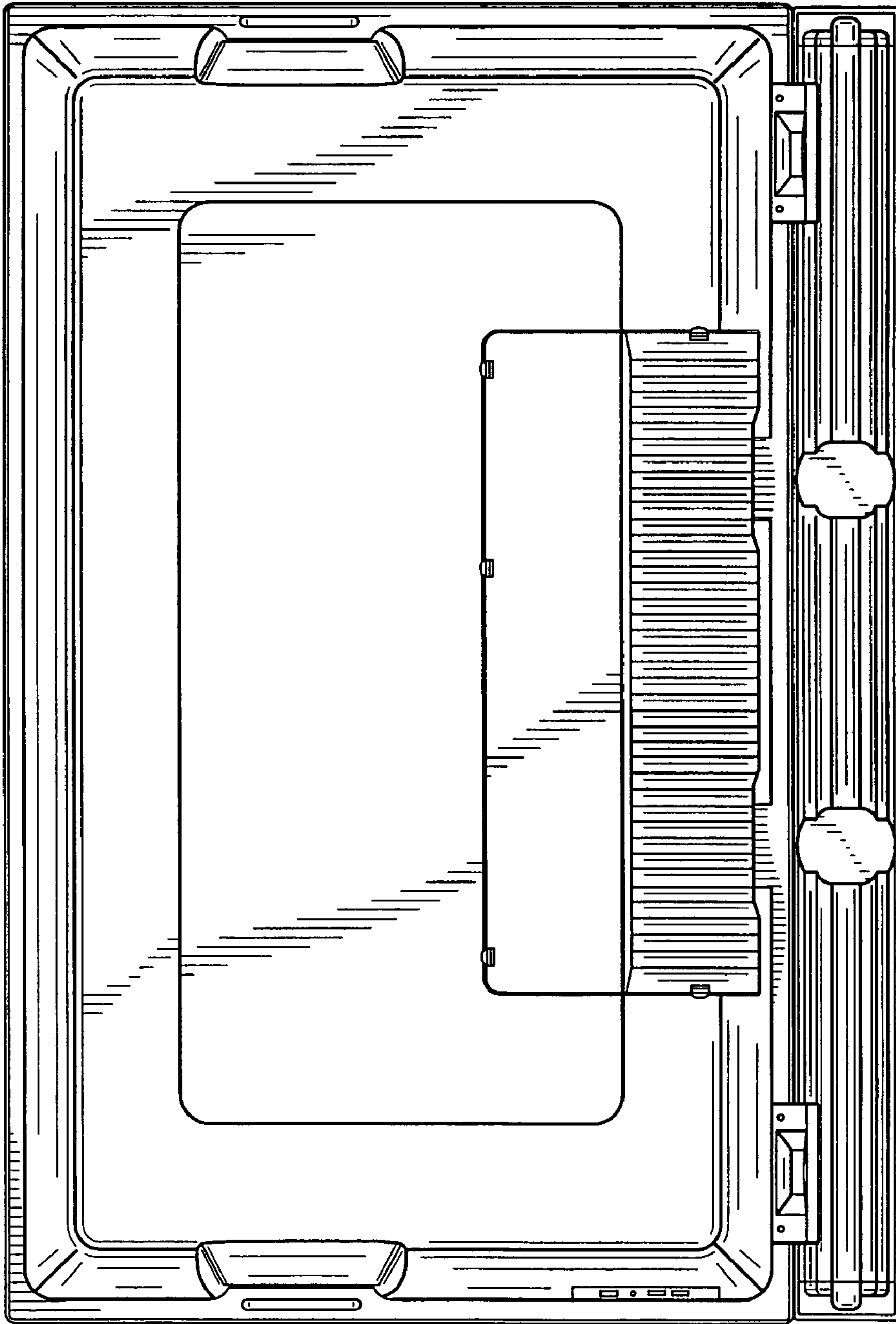

Fig. 3

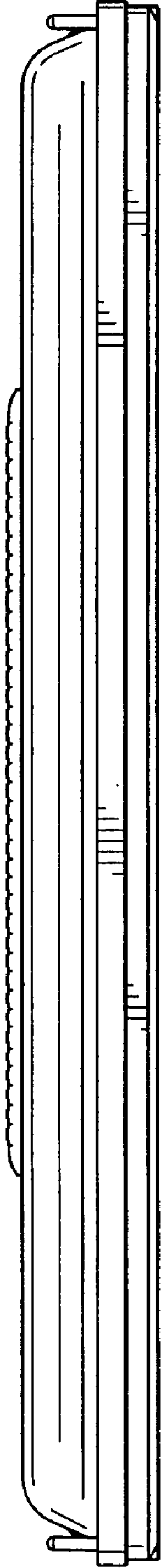

Fig. 4

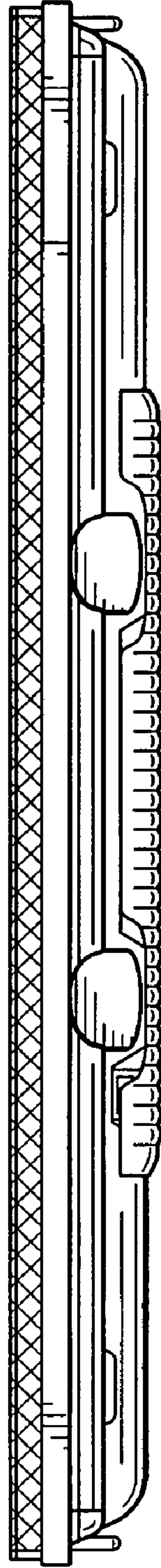

Fig. 5

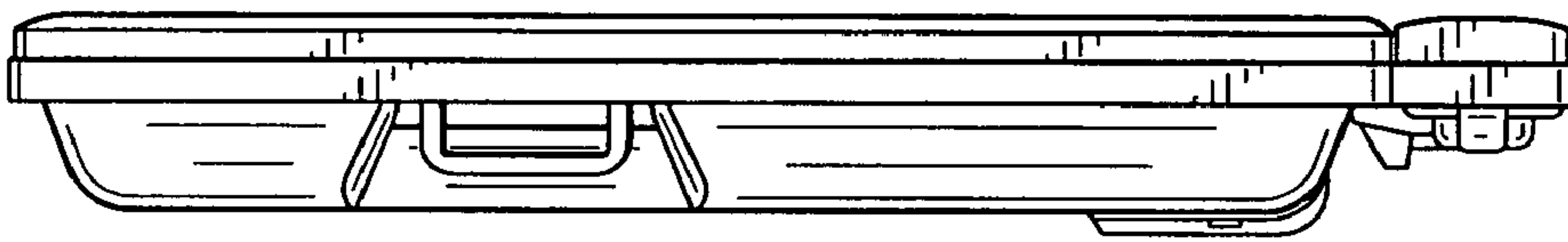

Fig. 7

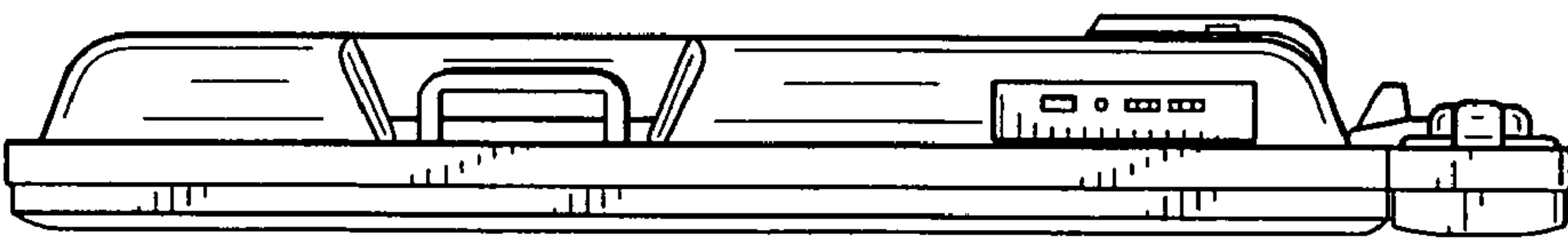

Fig. 6