



US00D551037S

(12) **United States Design Patent**
Mandel

(10) **Patent No.:** **US D551,037 S**

(45) **Date of Patent:** **** Sep. 18, 2007**

(54) **SHOT GLASS HOLDER**

(75) Inventor: **Joseph Mandel**, Highland Mills, NY
(US)

(73) Assignee: **Godinger Silver Art Co., Ltd.**,
Ridgewood, NY (US)

(**) Term: **14 Years**

(21) Appl. No.: **29/261,935**

(22) Filed: **Jun. 22, 2006**

(51) **LOC (8) Cl.** **07-06**

(52) **U.S. Cl.** **D7/702**

(58) **Field of Classification Search** D7/619.2,
D7/625, 702, 606, 604, 629; D21/533, 548,
D21/549, 550; 62/457.1-457.7; 220/737;
211/70.1, 71.01, 74

See application file for complete search history.

(56) **References Cited**

U.S. PATENT DOCUMENTS

D370,833 S * 6/1996 Vance D7/606
D402,997 S * 12/1998 Campbell et al. D15/7

D419,207 S * 1/2000 Lieberman D21/549
D428,874 S * 8/2000 White D14/207
D434,949 S * 12/2000 Steinfels D7/606
D458,838 S * 6/2002 Mackelson D7/702

* cited by examiner

Primary Examiner—Terry A. Wallace

(74) *Attorney, Agent, or Firm*—Cohen Pontani Lieberman &
Pavane LLP

(57) **CLAIM**

The ornamental design for a shot glass holder, as shown and described.

DESCRIPTION

FIG. 1 is a front and left side perspective view;
FIG. 2 is a top view;
FIG. 3 is a front view;
FIG. 4 is a rear view;
FIG. 5 is a left side view, the right side being a mirror image thereof; and,
FIG. 6 is a bottom view.

1 Claim, 5 Drawing Sheets

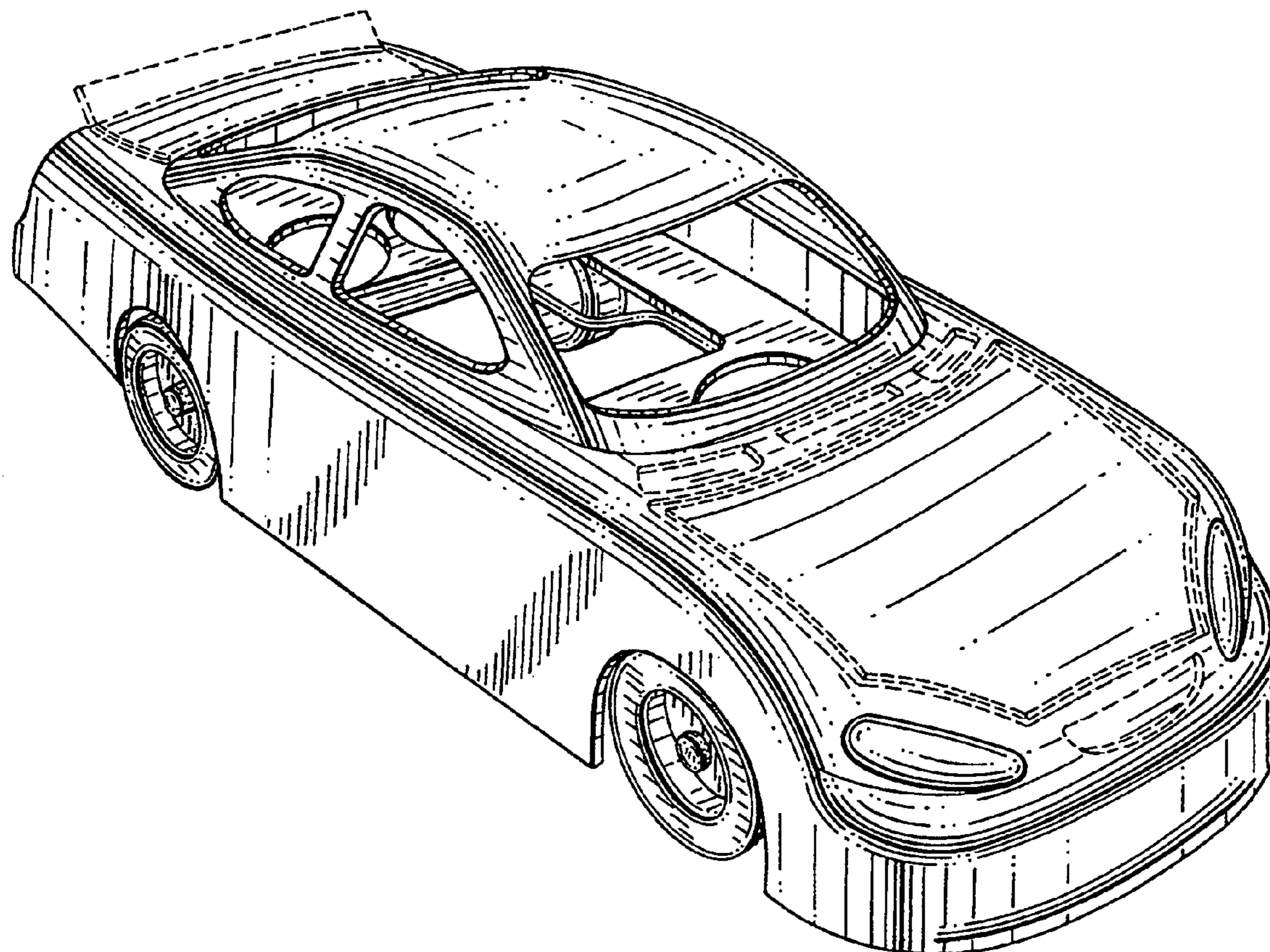

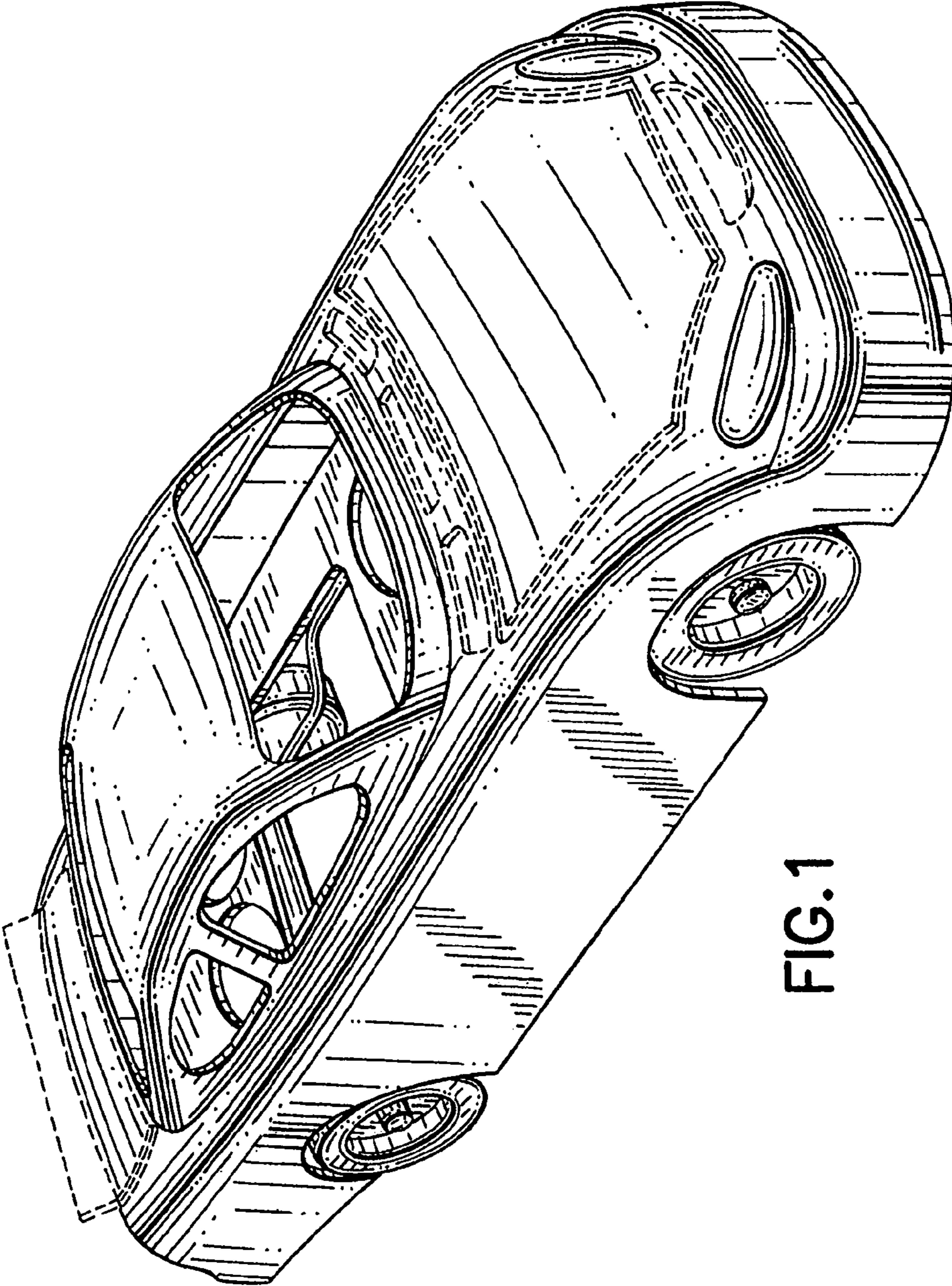

FIG.1

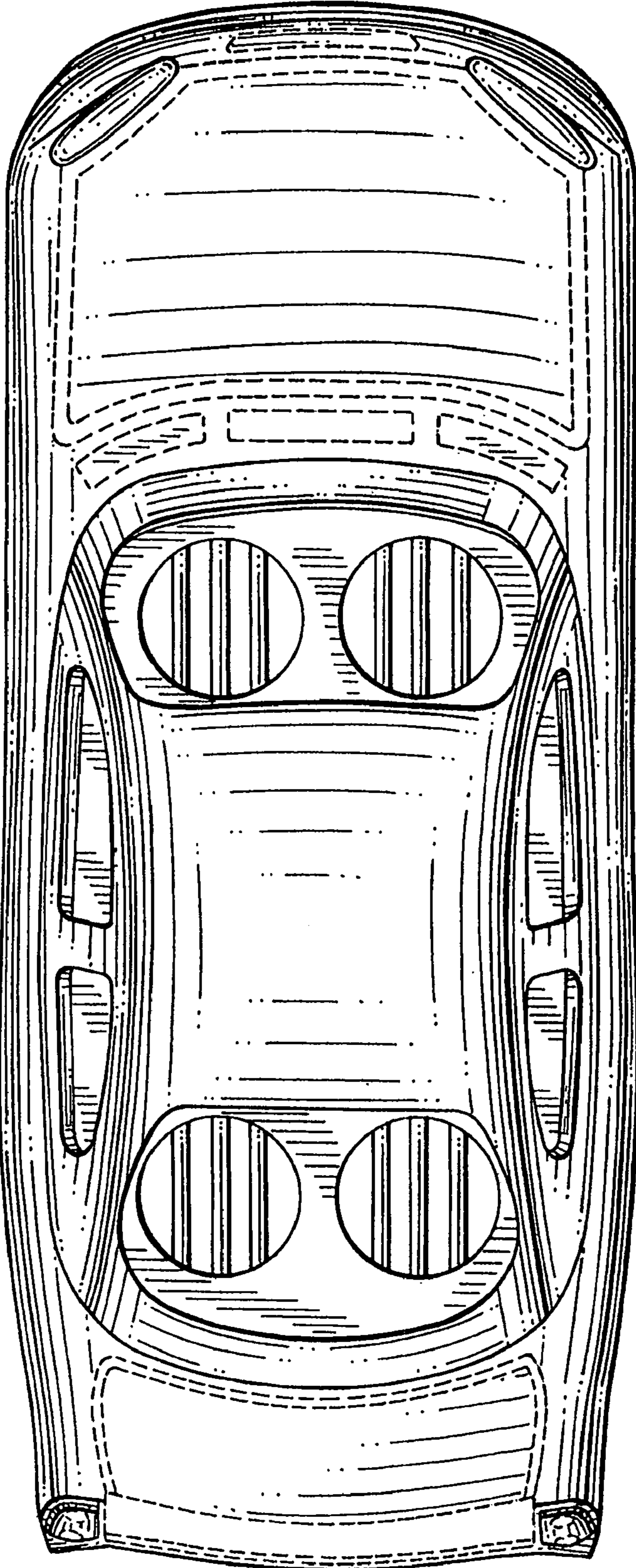

FIG.2

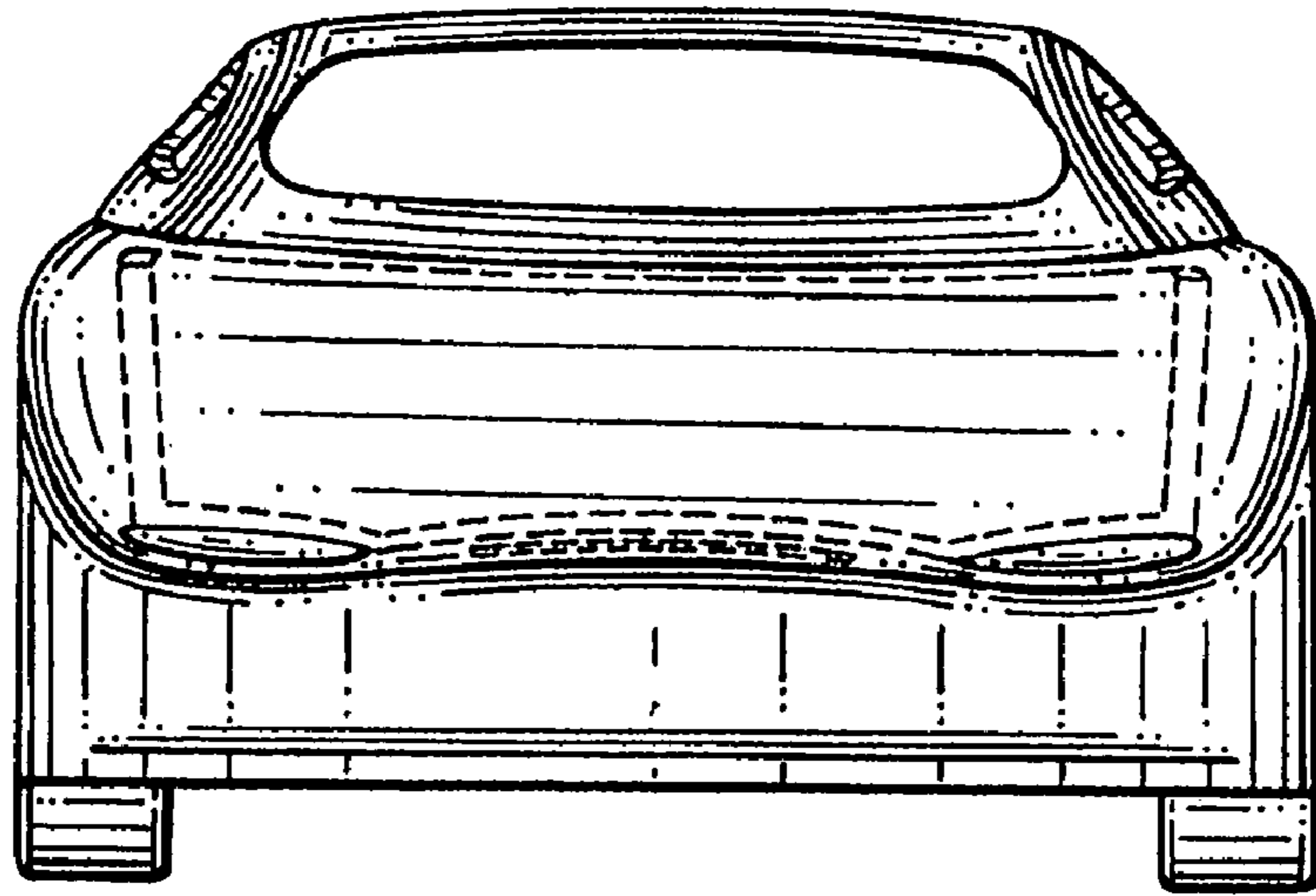

FIG. 3

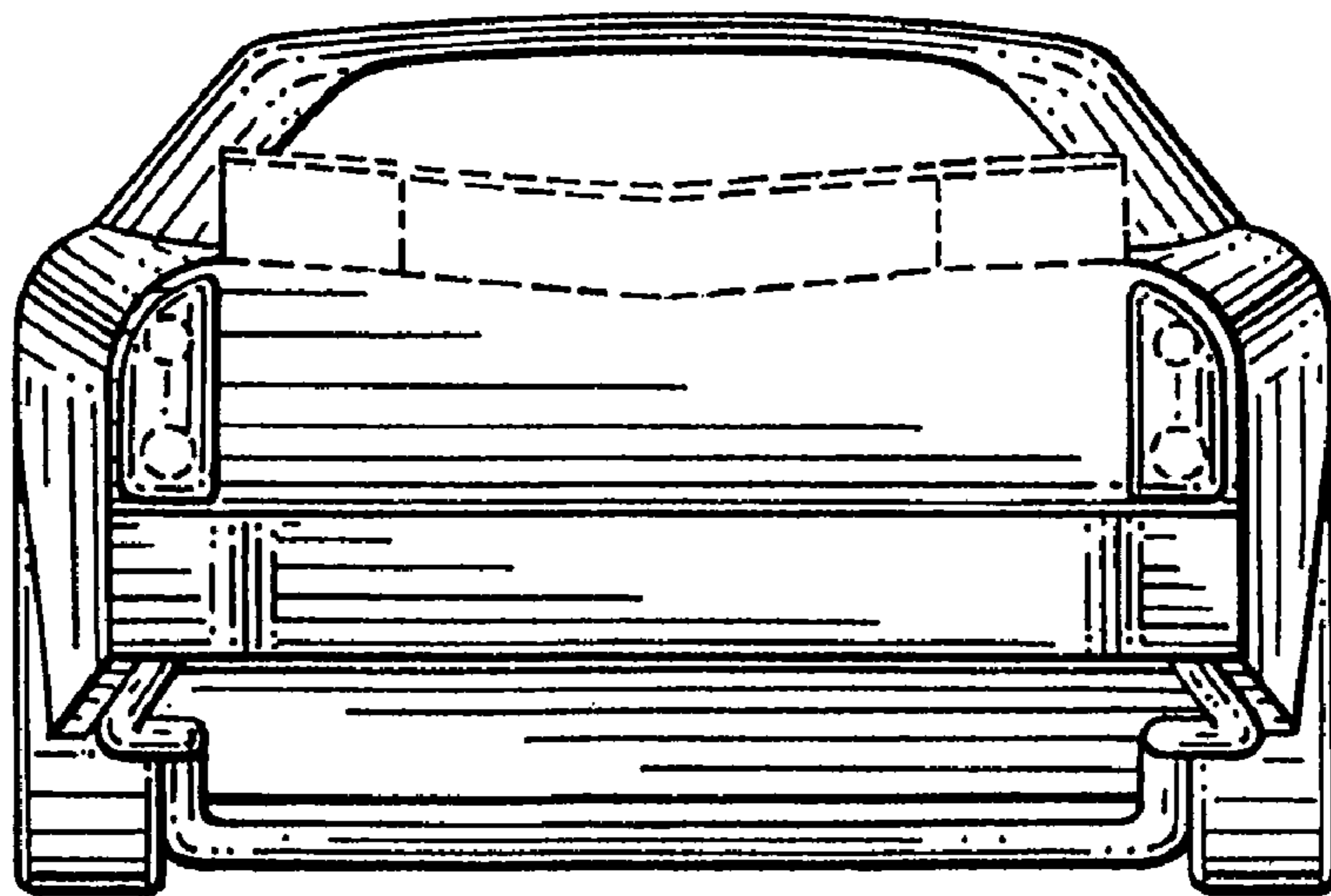

FIG. 4

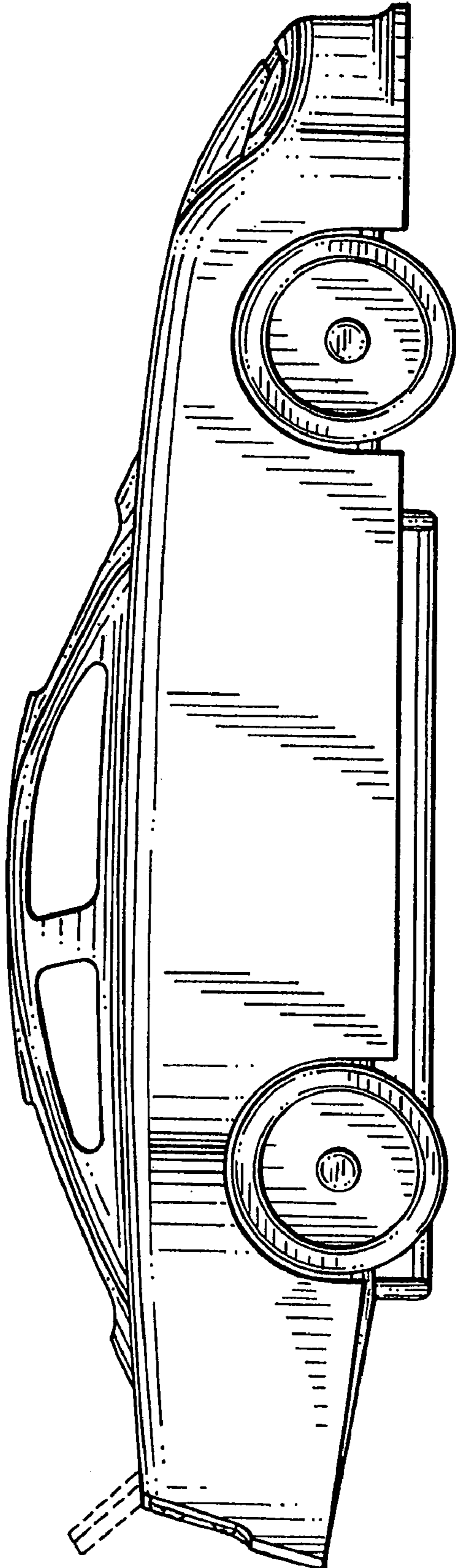

FIG.5

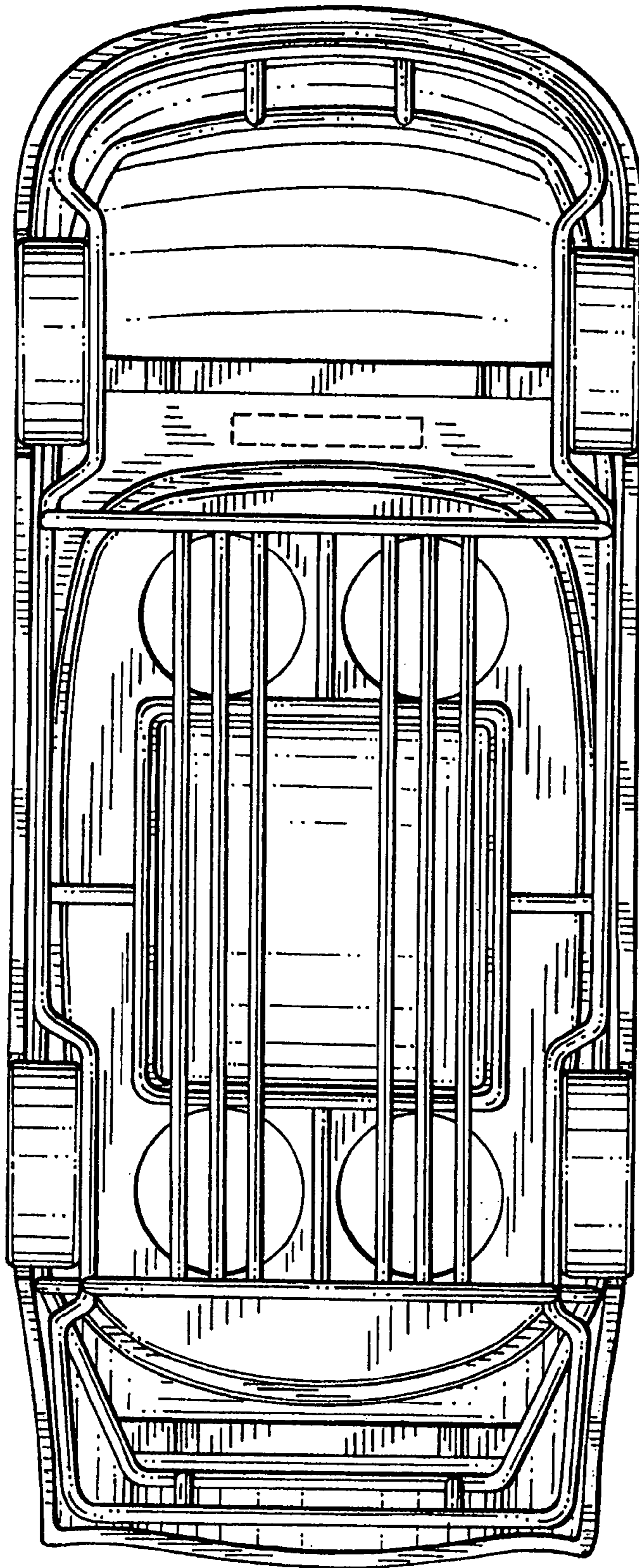

FIG.6