



US00D550979S

(12) **United States Design Patent**
Clark

(10) **Patent No.:** **US D550,979 S**

(45) **Date of Patent:** **** Sep. 18, 2007**

(54) **BENCH**

D441,204 S * 5/2001 Bernich D6/334

(76) Inventor: **Dennis Clark**, 28 Lane Gate Rd., Cold Spring, NY (US) 10516

* cited by examiner

Primary Examiner—Sandra Snapp

(74) *Attorney, Agent, or Firm*—Donald J. Ranft; Collen IP

(**) Term: **14 Years**

(21) Appl. No.: **29/277,516**

(57) **CLAIM**

(22) Filed: **Feb. 28, 2007**

The ornamental design for a bench, as shown and described.

(51) **LOC (8) Cl.** **06-01**

DESCRIPTION

(52) **U.S. Cl.** **D6/381**

(58) **Field of Classification Search** D6/334–337,
D6/346, 377, 381, 500–502; 297/232, 445.1;
5/12.1, 12.2

FIG. 1 is a front right perspective view of my new, original and ornamental design for a bench;

FIG. 2 is a left side view thereof;

FIG. 3 is a front view thereof;

FIG. 4 is a top view thereof;

FIG. 5 is a rear view thereof;

FIG. 6 is a left rear perspective thereof; and,

FIG. 7 is a bottom right perspective thereof.

See application file for complete search history.

(56) **References Cited**

U.S. PATENT DOCUMENTS

- 3,312,503 A * 4/1967 Suzuki 297/440.12
- D352,182 S * 11/1994 Yoshimura D6/368
- D395,557 S * 6/1998 Smith D6/334
- D399,660 S * 10/1998 Smith D6/334

1 Claim, 4 Drawing Sheets

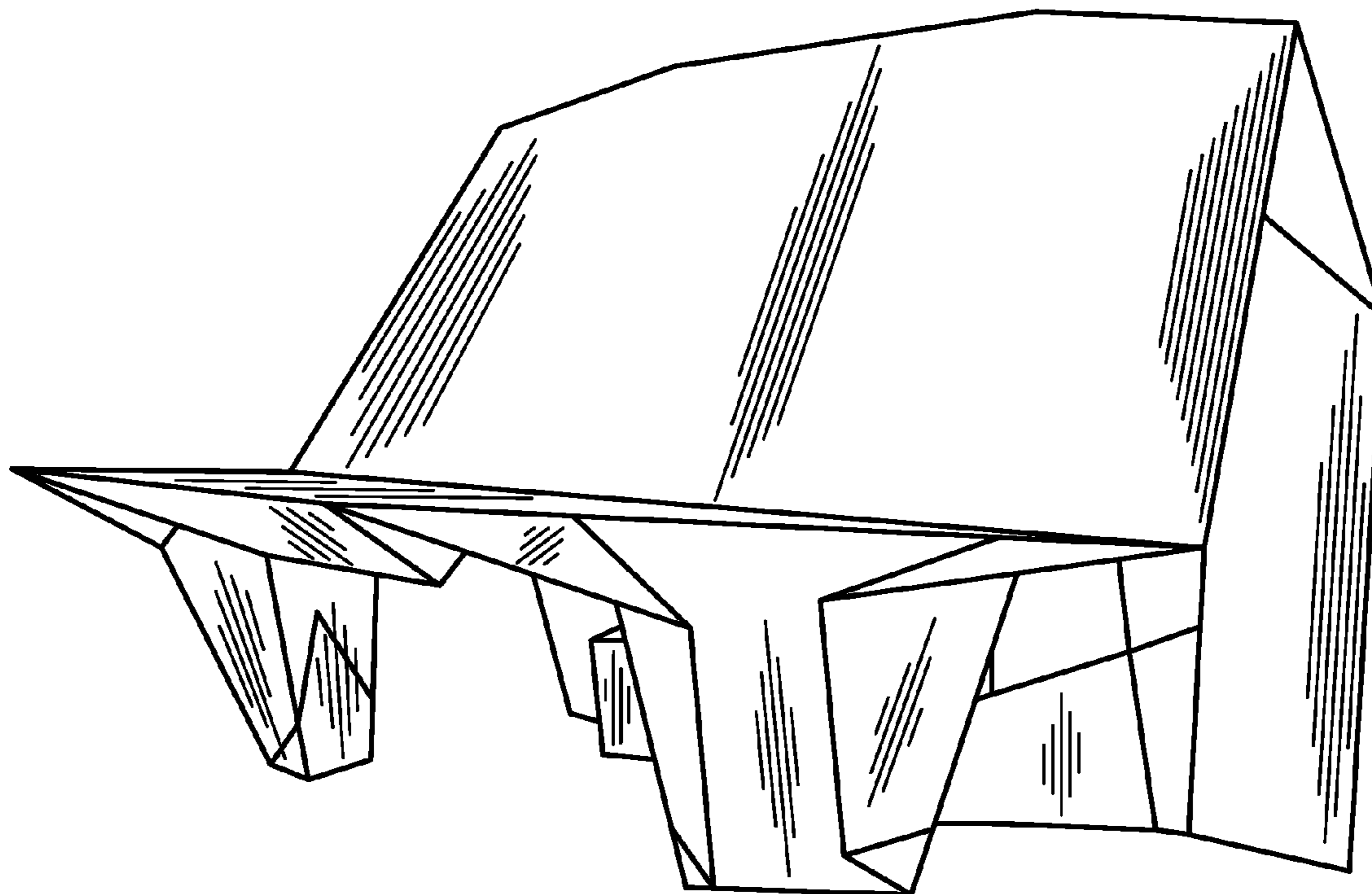

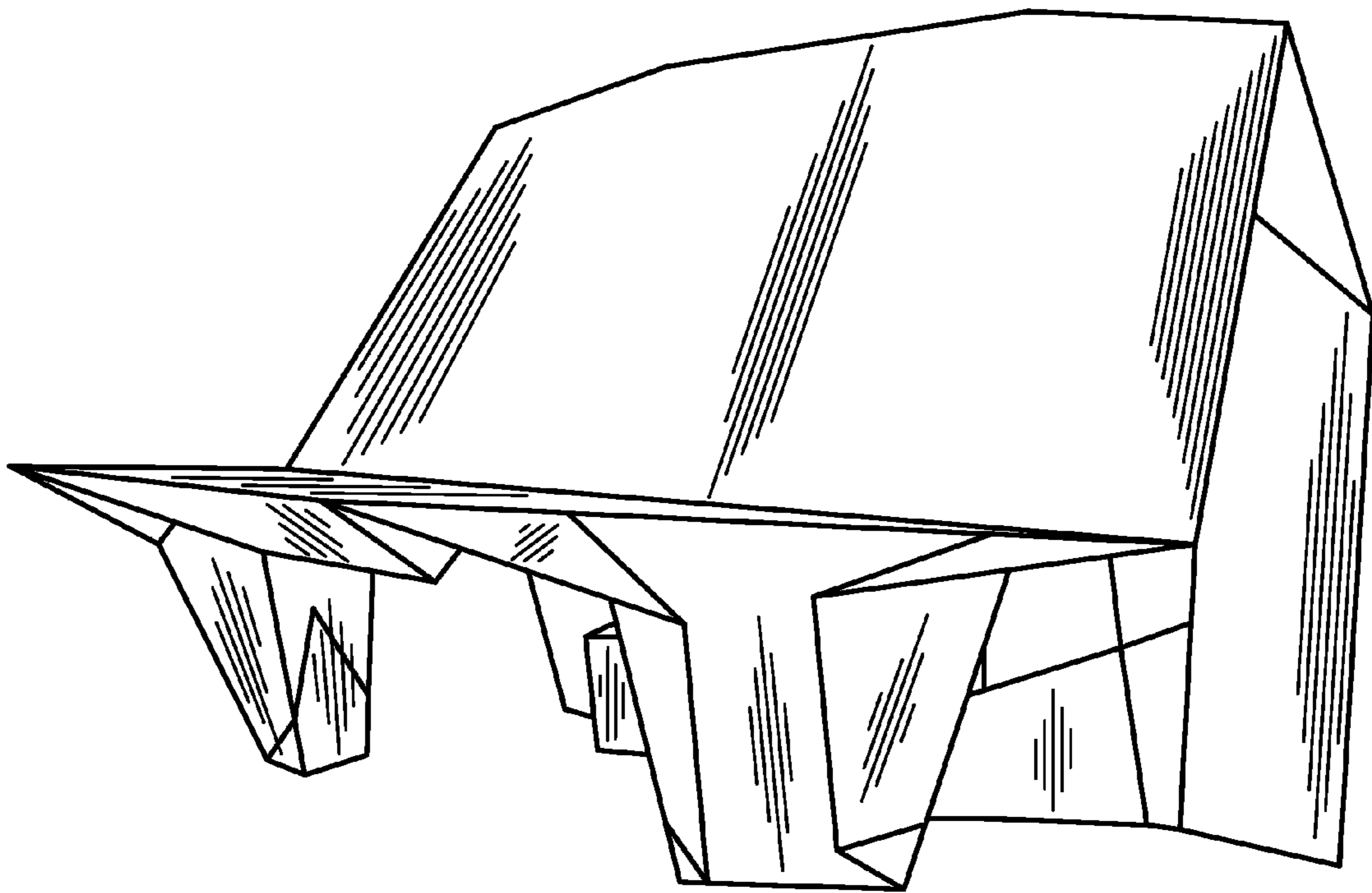

FIG. 1

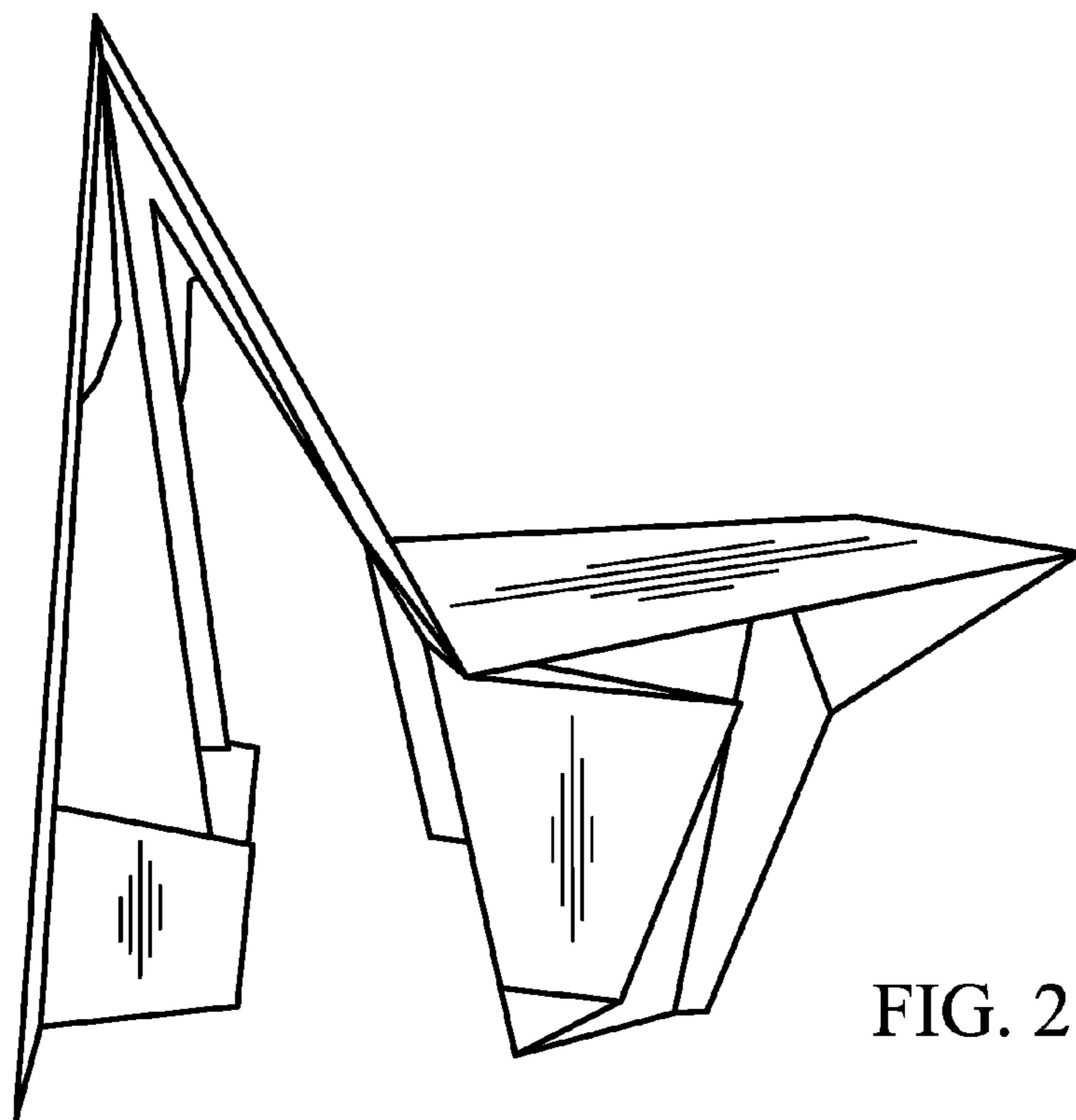

FIG. 2

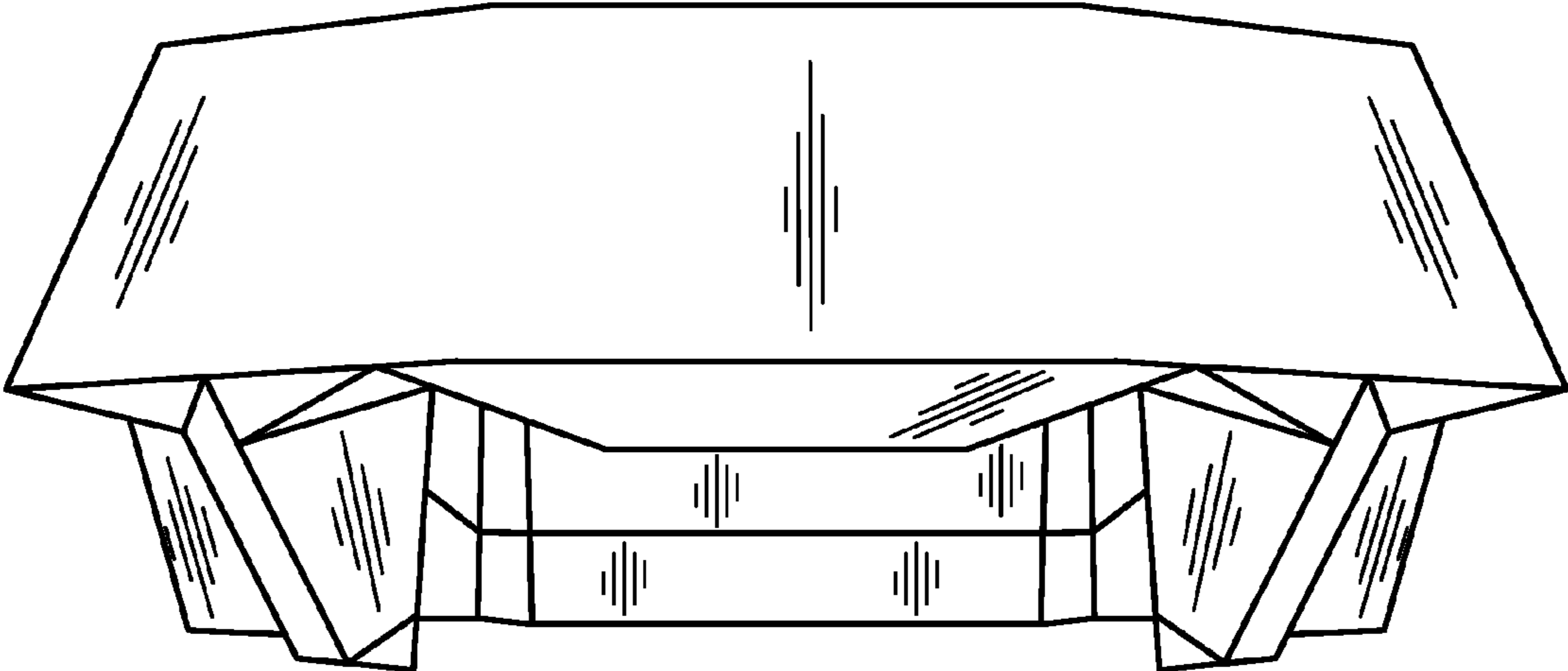

FIG. 3

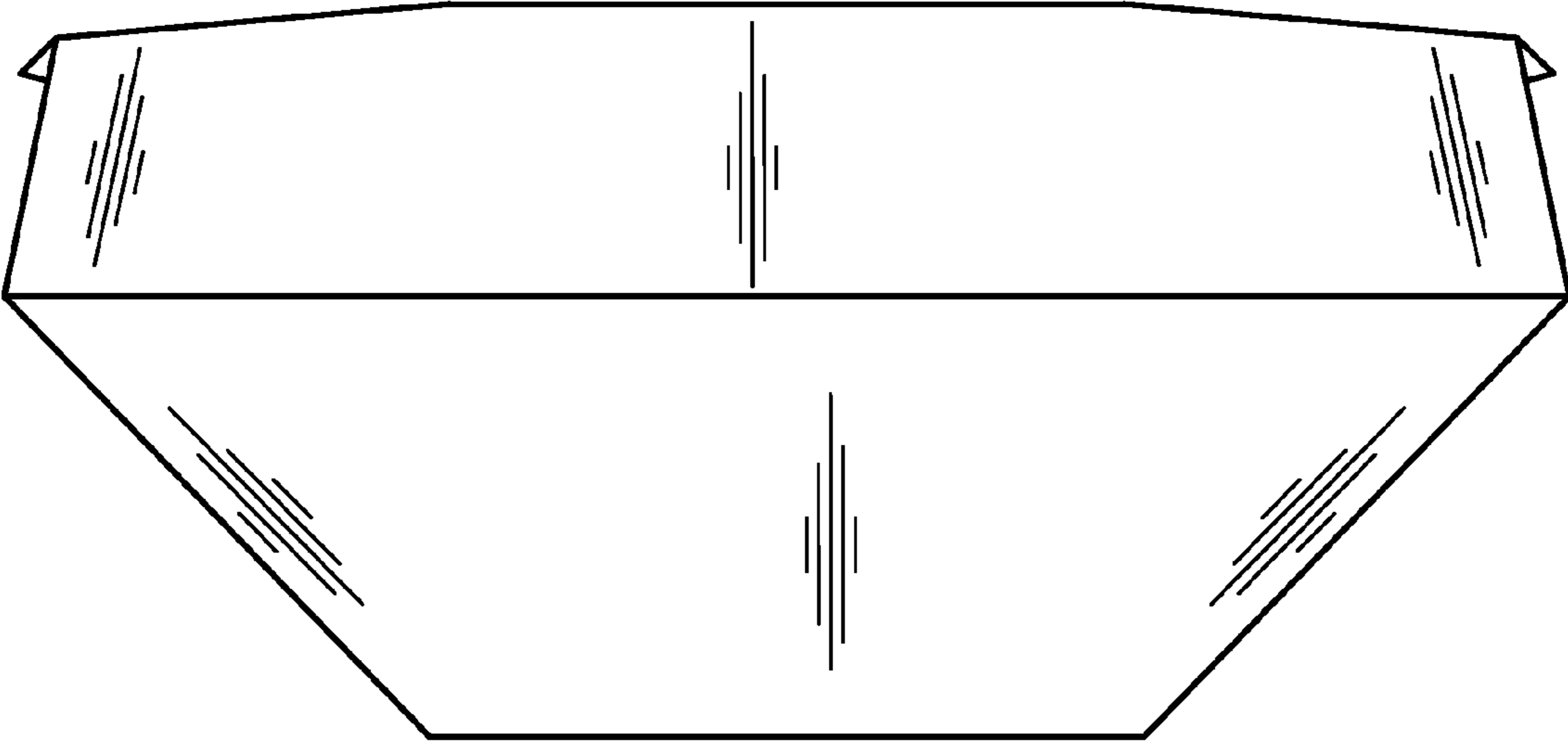

FIG. 4

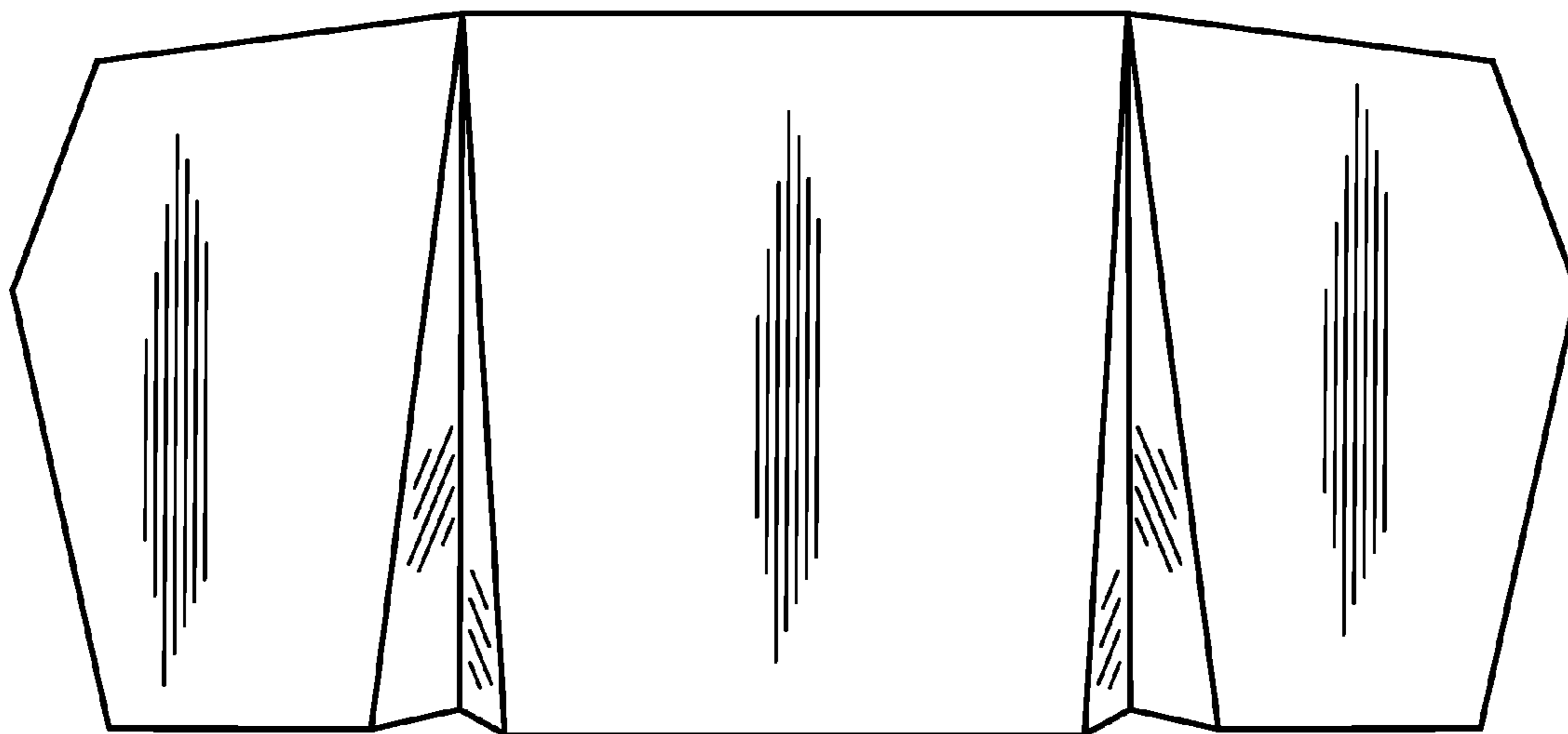

FIG. 5

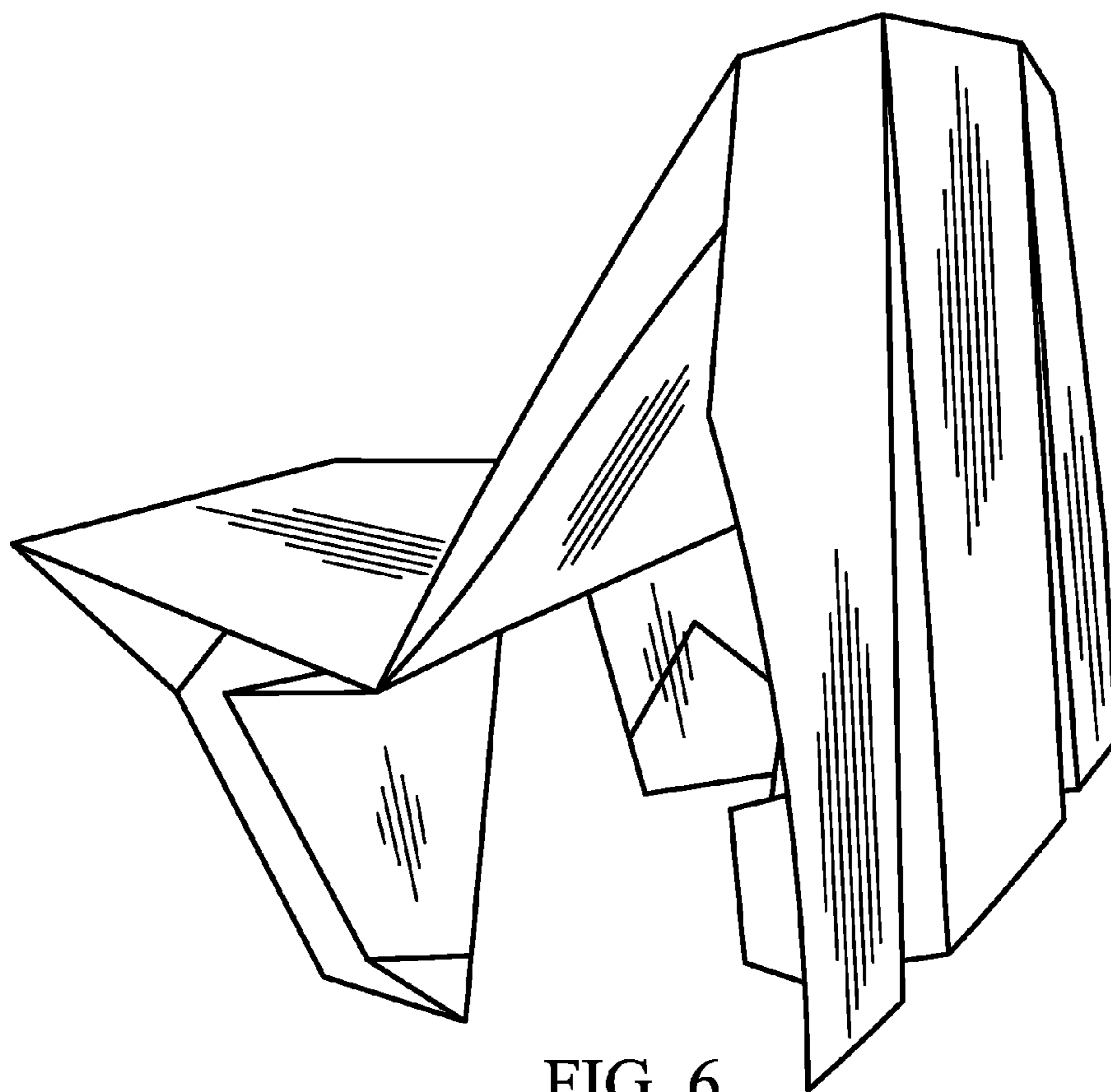

FIG. 6

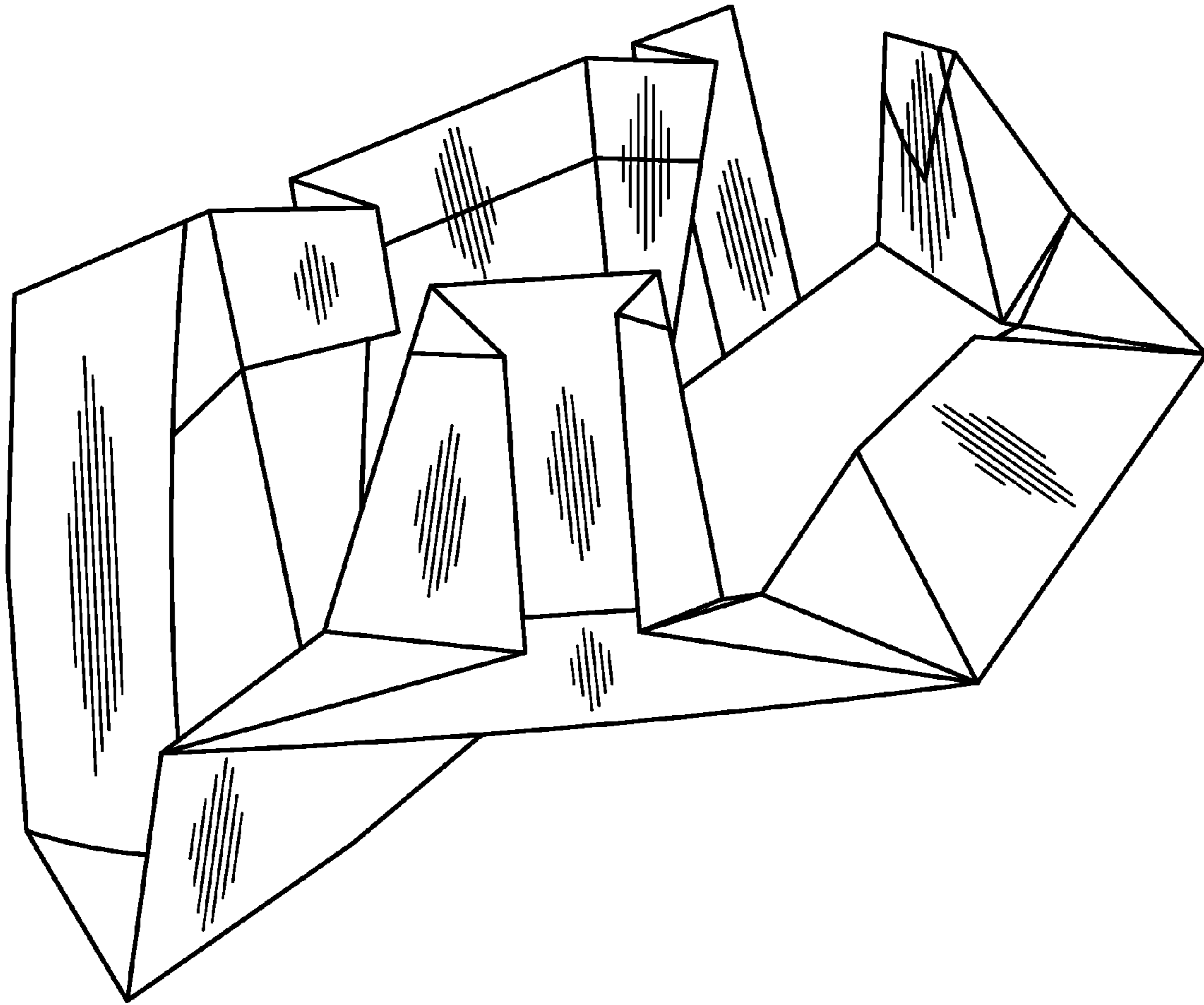

FIG. 7