



US00D550960S

(12) **United States Design Patent** (10) **Patent No.:** **US D550,960 S**
Schlegel (45) **Date of Patent:** **** Sep. 18, 2007**

(54) **COVER FOR VEHICLE MIRRORS**

(76) Inventor: **Edward G. Schlegel**, 140 S. 9th Ave.,
Brighton, CO (US) 80601

(**) Term: **14 Years**

(21) Appl. No.: **29/270,139**

(22) Filed: **Dec. 15, 2006**

D435,344 S *	12/2000	Harrison	D3/299
D446,270 S *	8/2001	Bernath	D21/754
D446,271 S *	8/2001	Kennedy	D21/754
6,286,964 B1 *	9/2001	Litmer	359/511
6,321,805 B1 *	11/2001	Suggs	150/160
6,325,121 B1 *	12/2001	Hudnall	150/166
D465,918 S *	11/2002	Burdine	D3/262
D469,608 S *	2/2003	Nevins	D3/300
D469,956 S *	2/2003	Cone et al.	D3/303
6,546,594 B1 *	4/2003	Wills	16/422

* cited by examiner

Related U.S. Application Data

(62) Division of application No. 29/221,720, filed on Jan. 20, 2005, now Pat. No. Des. 537,248.

(51) **LOC (8) Cl.** **03-01**

(52) **U.S. Cl.** **D3/300; D3/299; D12/400**

(58) **Field of Classification Search** D3/269,
D3/273, 283, 299-300, 303; D9/702-703,
D9/705, 707, 709, 711; D12/187-188, 400-401;
D21/754; 150/143, 146, 155, 160, 166; 206/454;
139/389-390; 383/43, 98, 210-211
See application file for complete search history.

(56) **References Cited**

U.S. PATENT DOCUMENTS

1,633,988 A *	6/1927	Jones	150/155
4,834,157 A *	5/1989	Smith	150/166
4,915,488 A *	4/1990	Lambert et al.	359/608
5,115,848 A *	5/1992	Malone	150/166
5,406,649 A *	4/1995	Bolembach	2/158
D371,237 S *	7/1996	Pfeifer	D3/276
D375,162 S *	10/1996	Gilbert	D24/134
D379,034 S *	5/1997	DeSatnick	D3/299
D390,529 S *	2/1998	Adams et al.	D12/401
D408,995 S *	5/1999	Kruse	D3/303
D420,899 S *	2/2000	Jubar	D9/705

Primary Examiner—Philip S. Hyder

Assistant Examiner—RoseLynne (Ulm) Cody

(74) *Attorney, Agent, or Firm*—The Reilly Intellectual Property Law Firm, P.C.; John E. Reilly; Ellen Reilly

(57) **CLAIM**

The ornamental design for a cover for vehicle mirrors, as shown and described.

DESCRIPTION

FIG. 1 is a perspective view of a cover for vehicle mirrors;

FIG. 2 is a front elevation view thereof;

FIG. 3 is a rear elevation view thereof;

FIG. 4 is an end view from the closed end thereof;

FIG. 5 is an end view from the open end thereof;

FIG. 6 is a top plan view thereof; and,

FIG. 7 is a bottom plan view thereof.

The broken lines used in FIGS. 1-3 of the drawing disclosure are for illustrative purposes only and form no part of the claimed design.

1 Claim, 3 Drawing Sheets

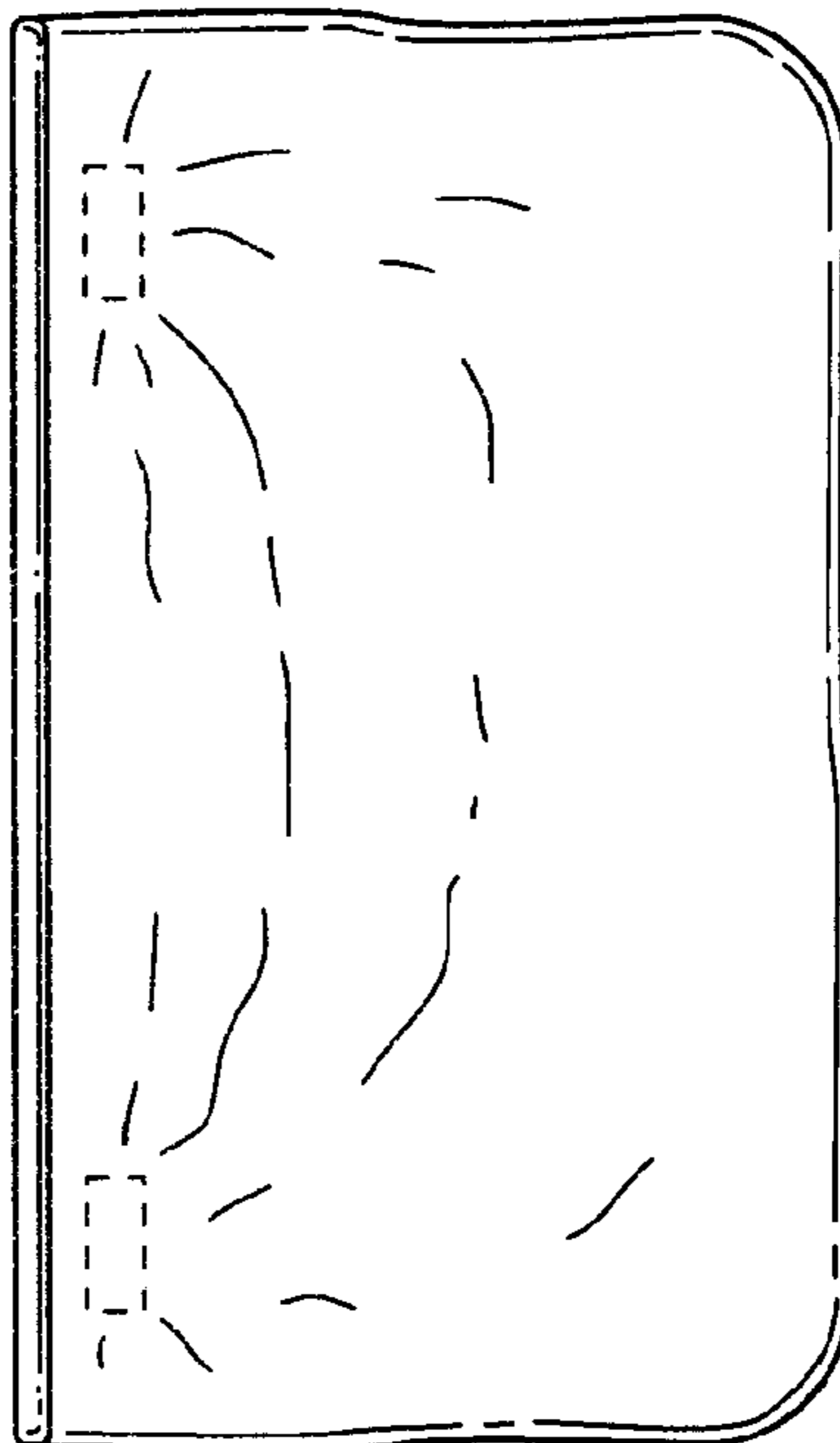

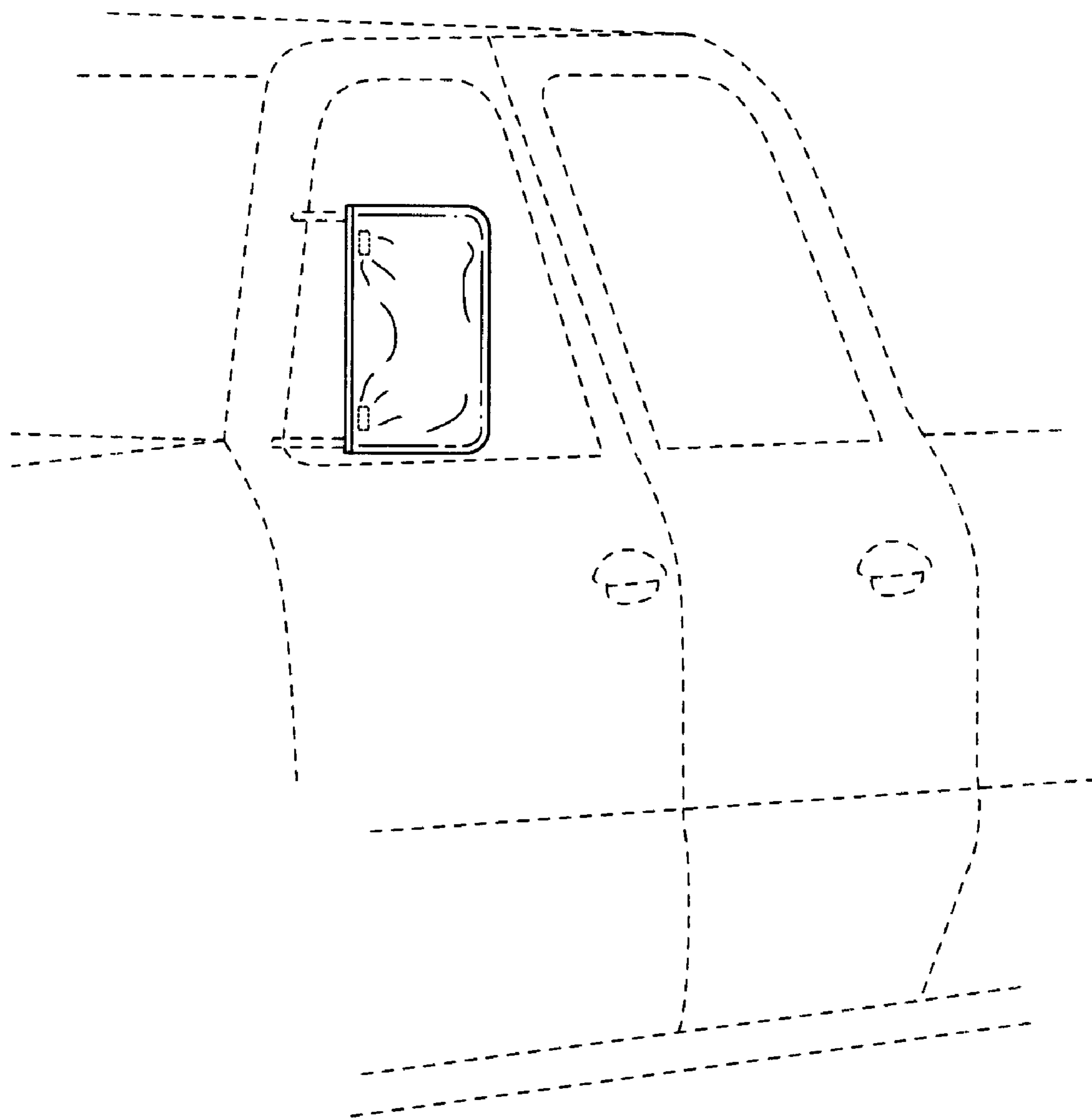

FIG.1

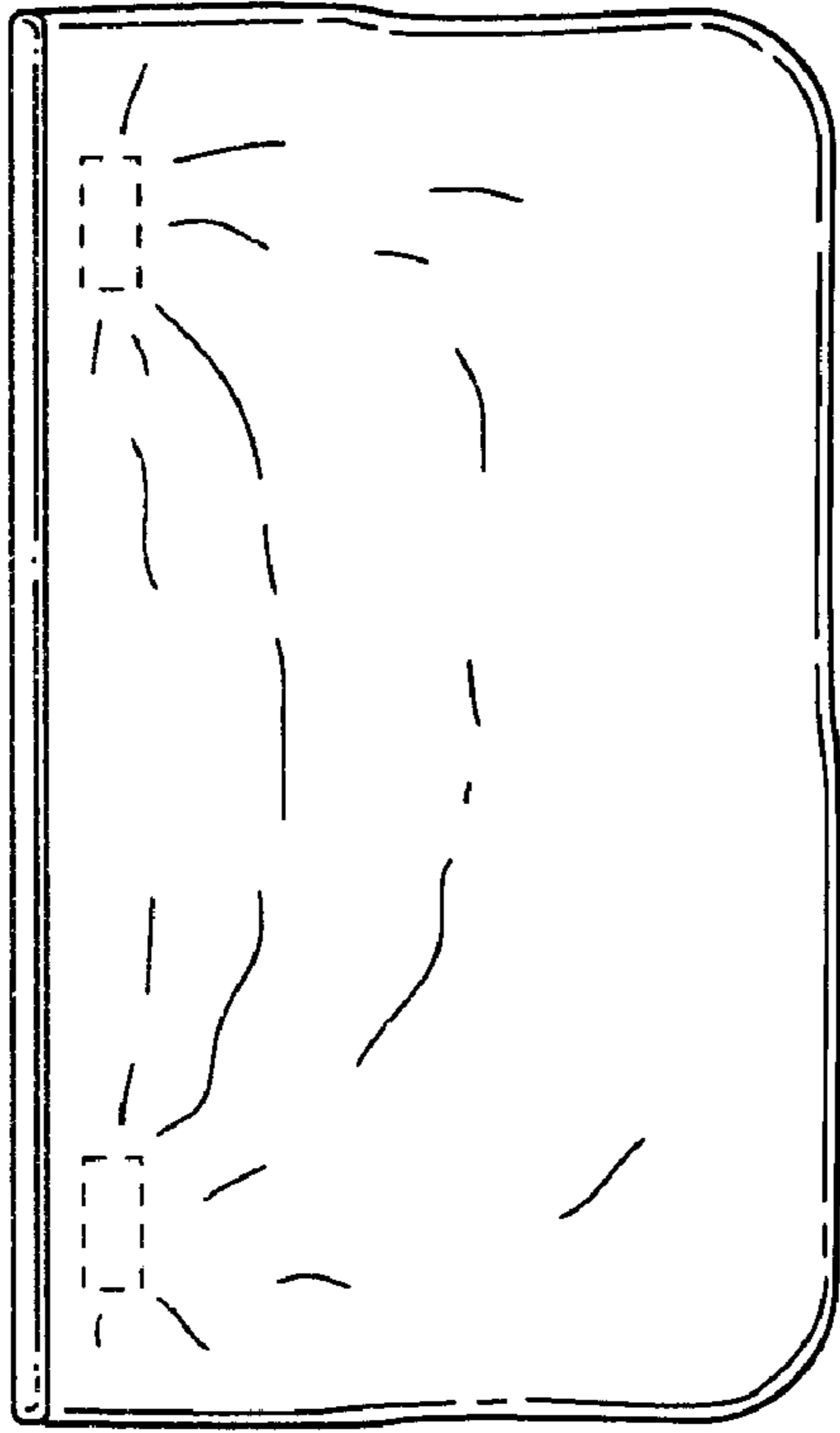

FIG.2

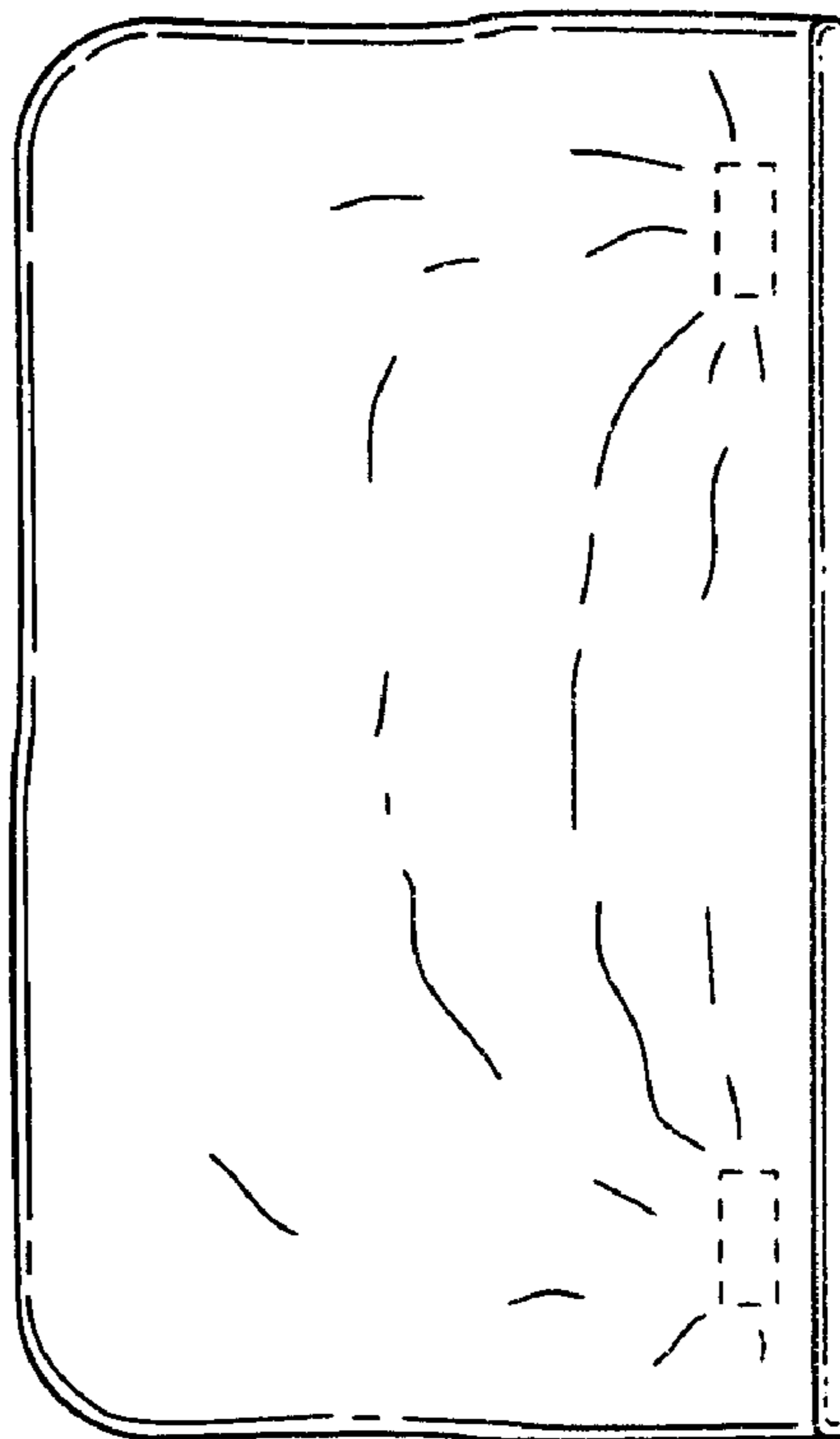

FIG.3

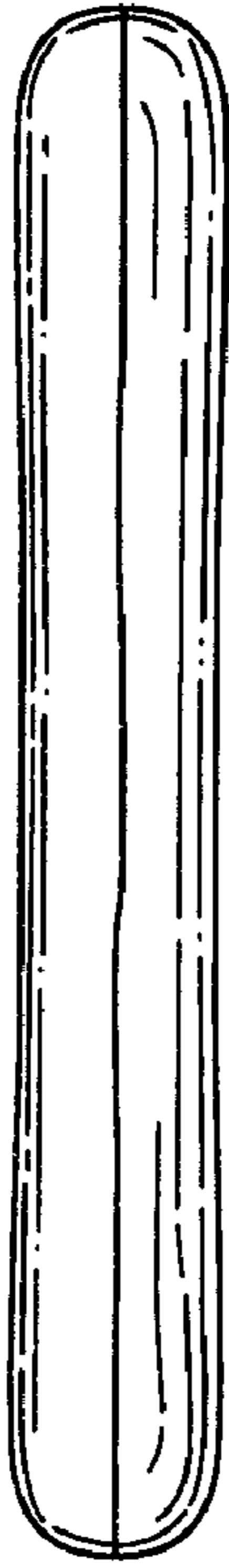

FIG.4



FIG.5

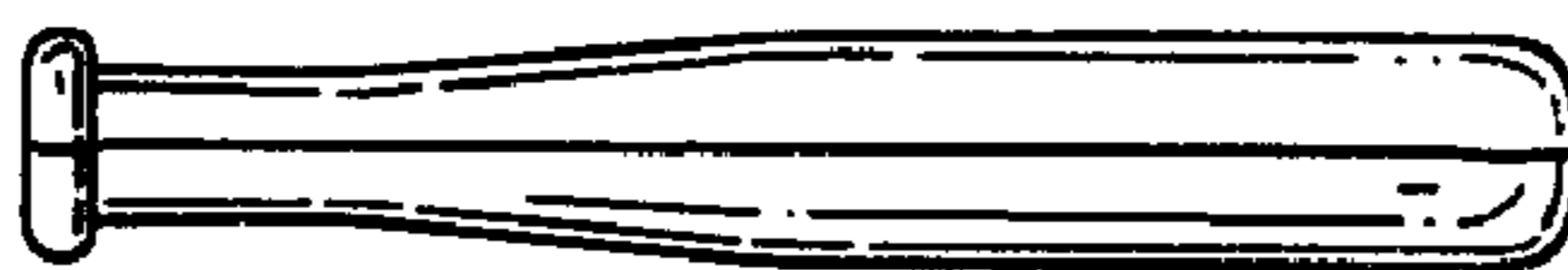

FIG.6

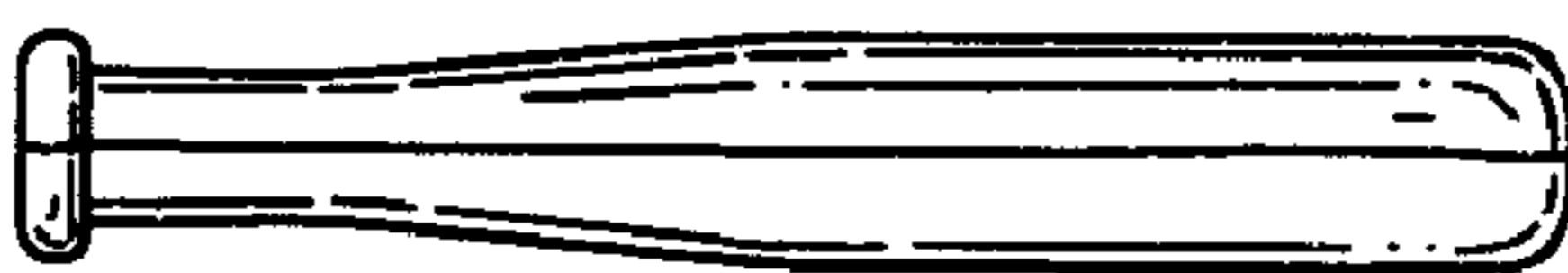

FIG.7