



US00D550933S

(12) **United States Design Patent**
Hulbert

(10) **Patent No.:** **US D550,933 S**

(45) **Date of Patent:** **** Sep. 18, 2007**

(54) **SHOE**

D501,295 S * 2/2005 Belley et al. D2/969
D501,298 S * 2/2005 Robbins et al. D2/969

(75) Inventor: **Emily Louise Hulbert**, Chesham (GB)

* cited by examiner

(73) Assignee: **Lacoste Alligator S.A.**, Geneva (CH)

Primary Examiner—Stella Reid

(**) Term: **14 Years**

Assistant Examiner—Rashida C. McCoy

(21) Appl. No.: **29/245,441**

(74) *Attorney, Agent, or Firm*—Fross Zelnick Lehrman & Zissu, P.C.; David I. Greenbaum, Esq.

(22) Filed: **Dec. 21, 2005**

(57) **CLAIM**

(30) **Foreign Application Priority Data**

The ornamental design for a shoe, as shown and described.

Jun. 22, 2005 (CN) 2005 3 0019043

DESCRIPTION

(51) **LOC (8) Cl.** **02-04**

FIG. 1 is a front perspective view of a shoe showing my new design;

(52) **U.S. Cl.** **D2/902; D2/969**

(58) **Field of Classification Search** D2/902,
D2/896, 903, 906–908, 943, 944, 969, 972–974;
36/45, 50.1, 77 M, 77 R, 83, 88, 113, 114,
36/126–131

FIG. 2 is a front view of the shoe shown in FIG. 1;

FIG. 3 is a left side view of the shoe shown in FIG. 1;

FIG. 4 is a right side view of the shoe shown in FIG. 1;

FIG. 5 is a rear view of the shoe shown in FIG. 1;

FIG. 6 is a top view of the shoe shown in FIG. 1; and,

FIG. 7 is a bottom view of the shoe shown in FIG. 1.

See application file for complete search history.

The broken line showing of the sole is for illustrative purposes only and forms no part of the claimed design.

The dotted lines other than those representing the sole are understood to represent stitching.

(56) **References Cited**

U.S. PATENT DOCUMENTS

- D266,455 S * 10/1982 Famolare, Jr. D2/969
- D449,922 S * 11/2001 Pollastrelli D2/969
- D474,580 S * 5/2003 Pollastrelli D2/907
- D475,187 S * 6/2003 Shea et al. D2/969
- D487,957 S * 4/2004 Robbins D2/969
- D499,864 S * 12/2004 Belley et al. D2/969

1 Claim, 7 Drawing Sheets

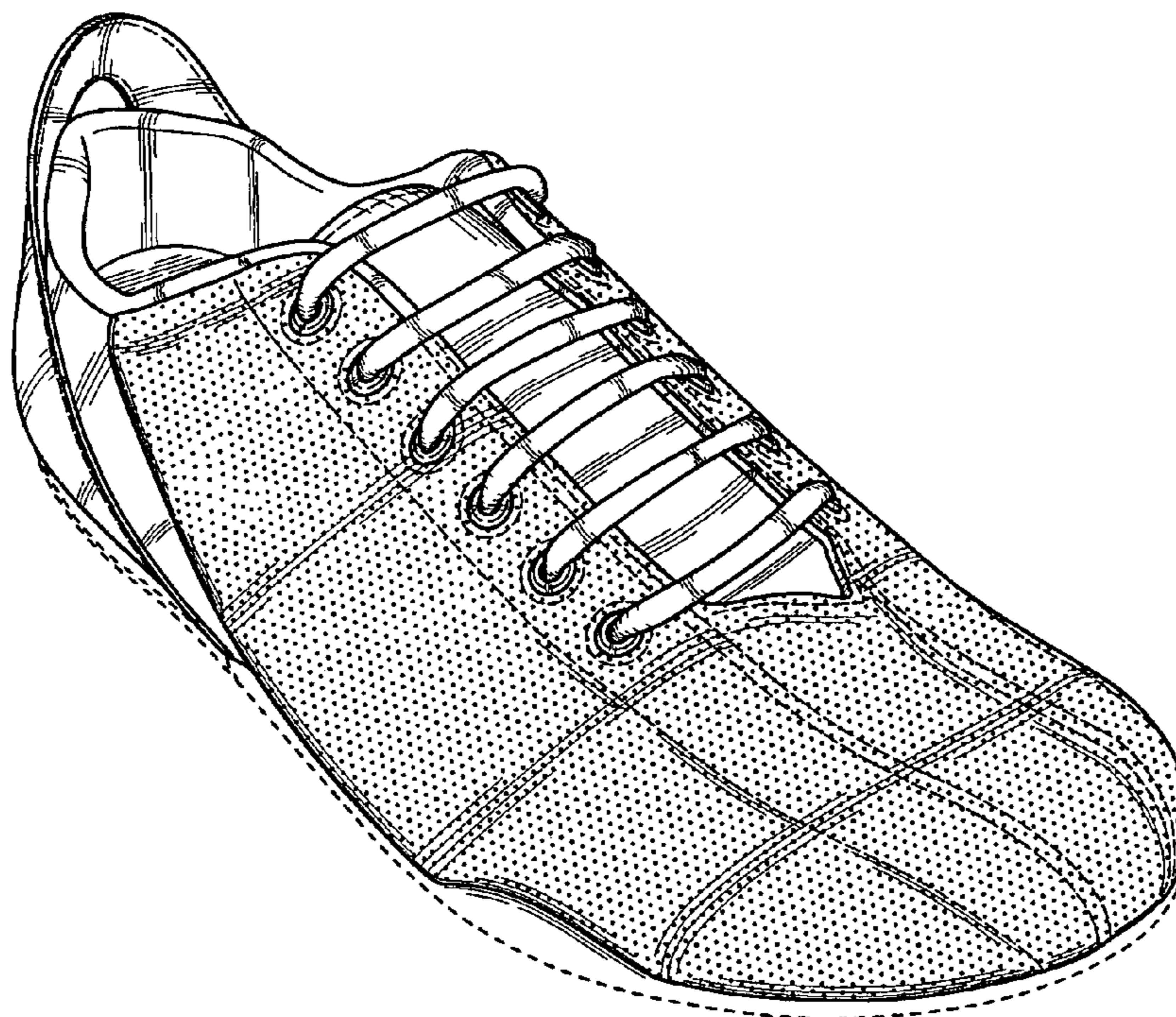

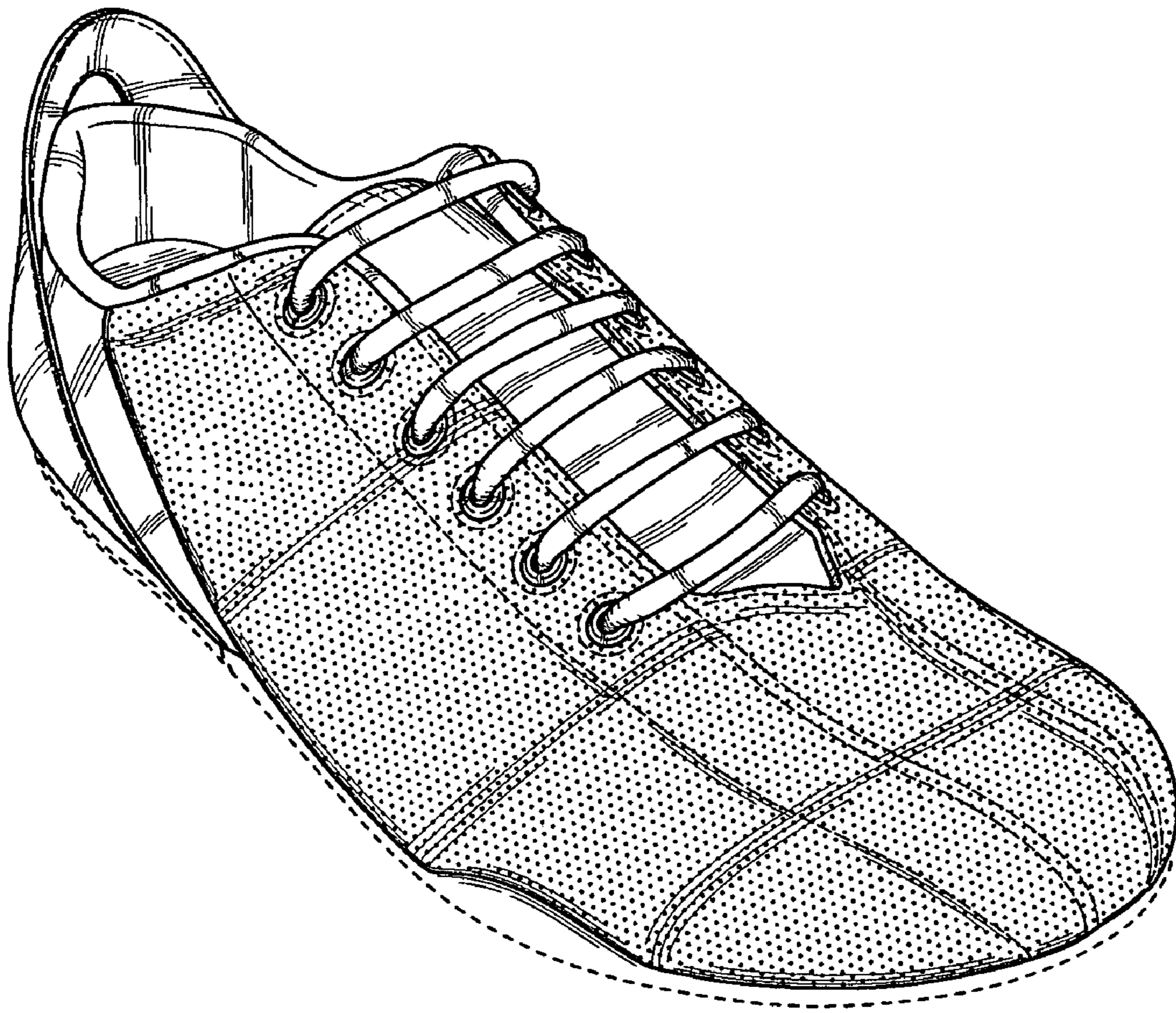

FIG. 1

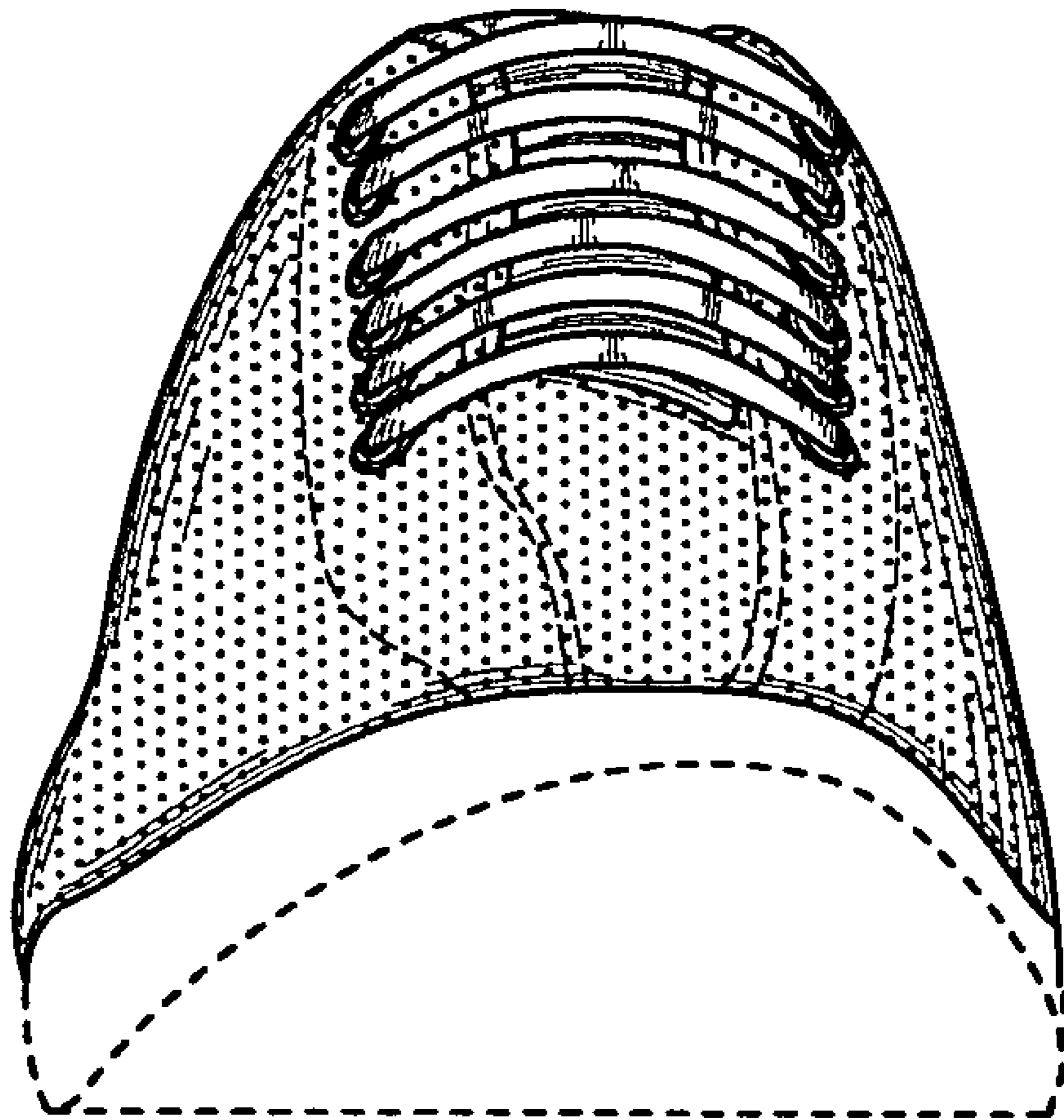

FIG. 2

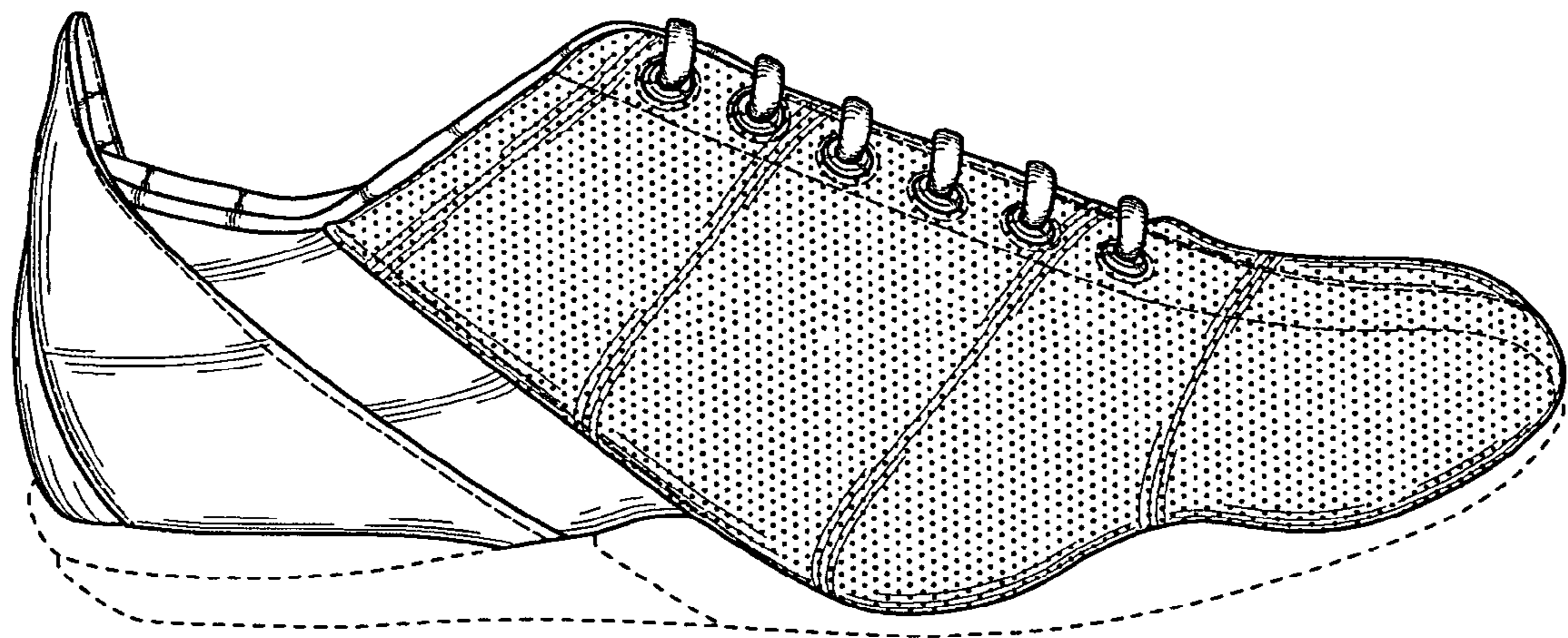

FIG. 3

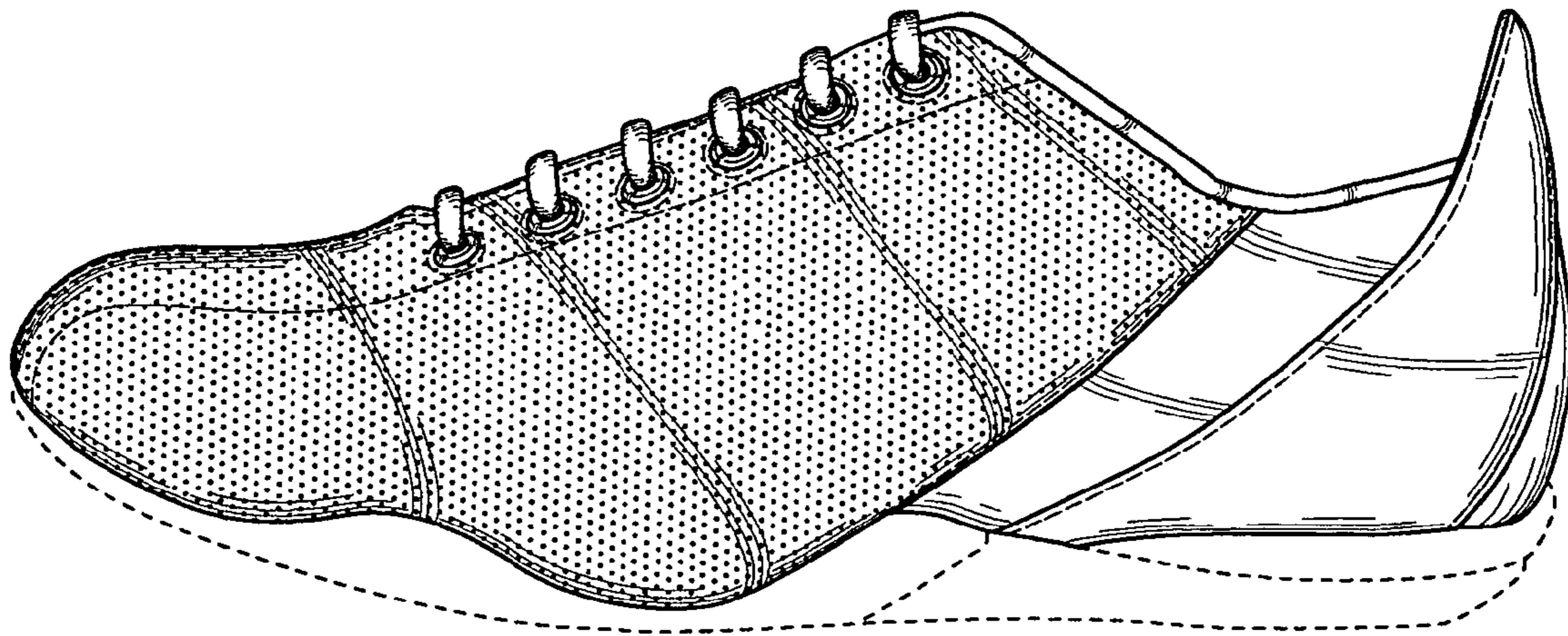

FIG. 4

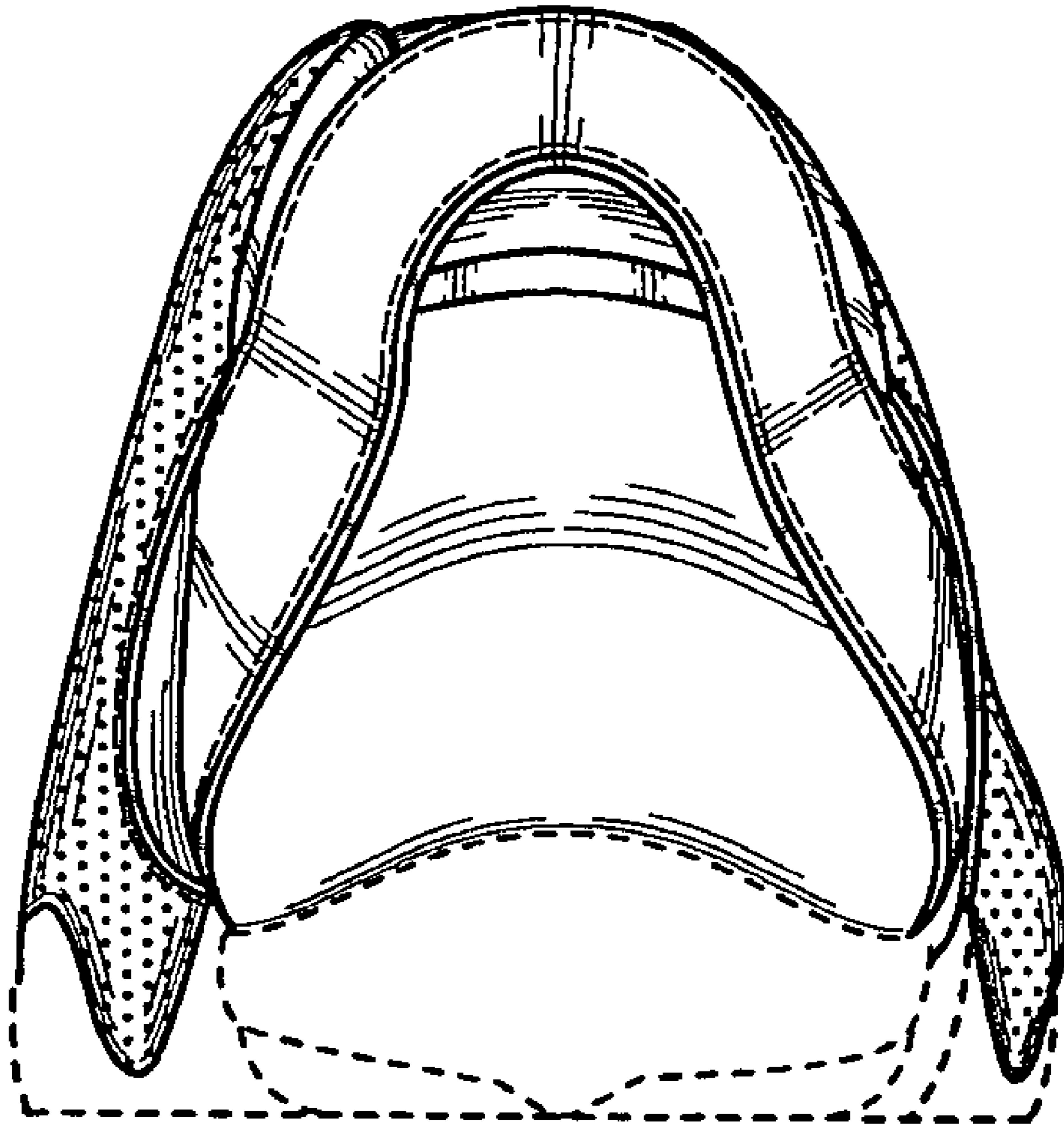

FIG. 5

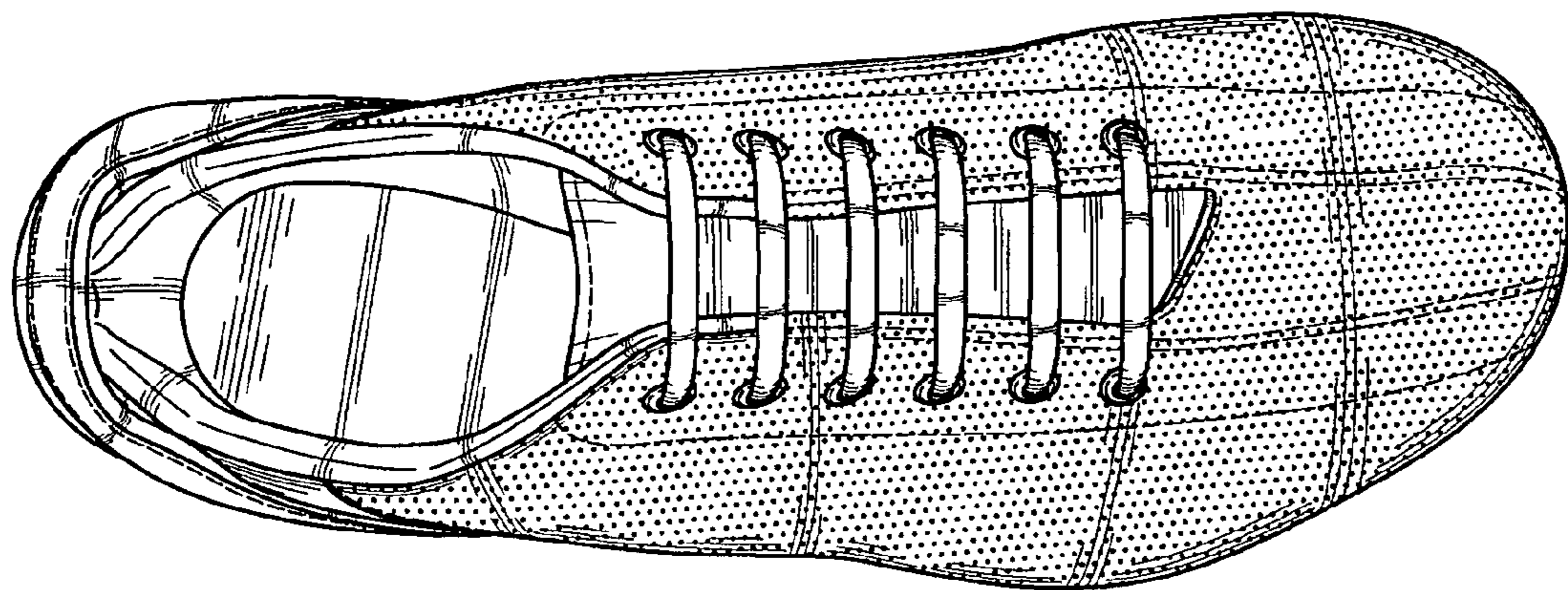

FIG. 6

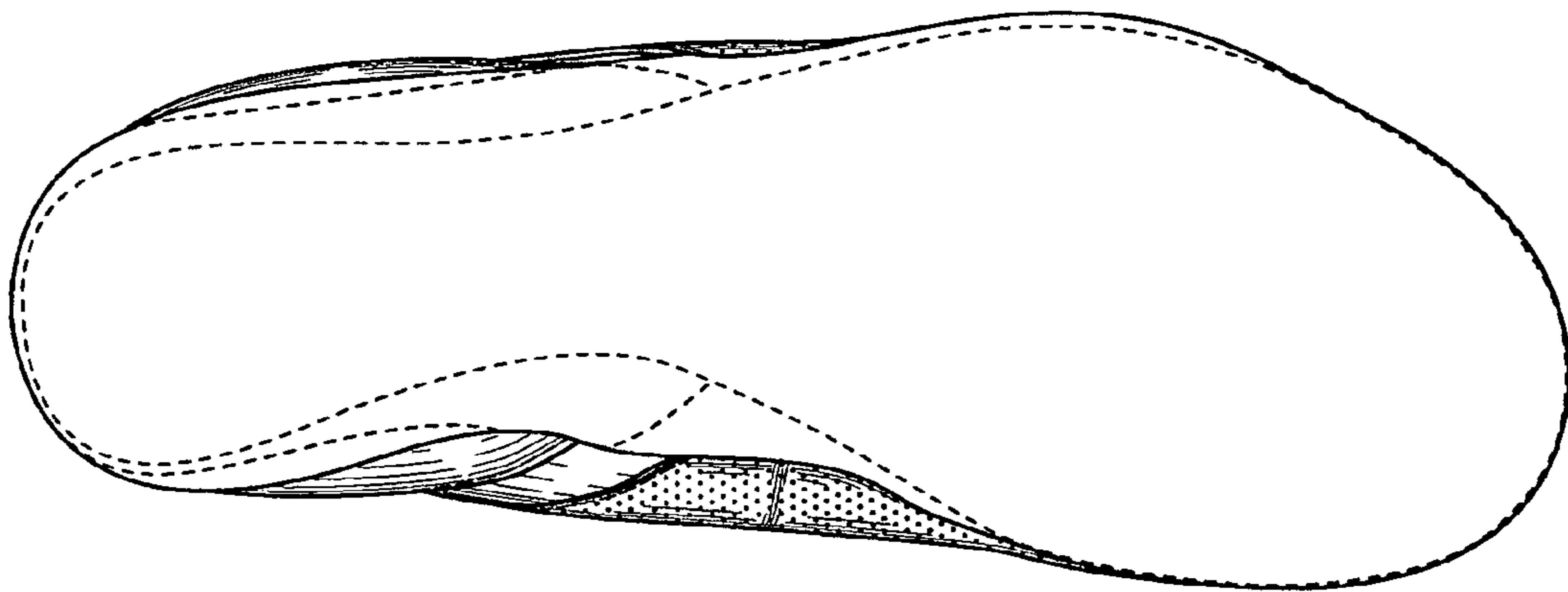

FIG. 7