



US00D550826S

(12) **United States Design Patent**
Murai

(10) **Patent No.:** **US D550,826 S**

(45) **Date of Patent:** **** Sep. 11, 2007**

(54) **AIR PURIFIER**

D544,082 S * 6/2007 Fujii D23/364

(75) Inventor: **Yuichi Murai**, Kusatsu (JP)

* cited by examiner

(73) Assignee: **Daikin Industries Ltd.**, Osaka (JP)

Primary Examiner—Louis Zarfes

Assistant Examiner—David G. Muller

(**) Term: **14 Years**

(74) *Attorney, Agent, or Firm*—Manabu Kanesaka

(21) Appl. No.: **29/265,679**

(57) **CLAIM**

(22) Filed: **Sep. 7, 2006**

The ornamental design for an air purifier, as shown and described.

(30) **Foreign Application Priority Data**

Jul. 5, 2006 (JP) 2006-017689

Jul. 5, 2006 (JP) 2006-017691

(51) **LOC (8) Cl.** **23-04**

(52) **U.S. Cl.** **D23/364**

(58) **Field of Classification Search** D23/364,
D23/355, 356, 359, 360, 362, 352, 366, 369,
D23/332, 333, 335, 336, 342; 422/120, 122;
55/356, 473, 504; 210/497.1; 96/97; D14/188,
D14/170, 172

See application file for complete search history.

(56) **References Cited**

U.S. PATENT DOCUMENTS

D282,570 S *	2/1986	Nakamura	D23/332
D472,626 S *	4/2003	Nakamura	D23/364
D489,800 S *	5/2004	Tokunaga	D23/364
D489,801 S *	5/2004	Shimizu	D23/364
D497,984 S *	11/2004	Tokunaga	D23/364
D503,787 S *	4/2005	Koike	D23/364
D513,432 S *	1/2006	Nakamura	D23/364
D514,211 S *	1/2006	Nakamura	D23/364
D529,154 S *	9/2006	Koike	D23/333
D536,433 S *	2/2007	Murai	D23/364
D537,157 S *	2/2007	Murai	D23/364
D544,081 S *	6/2007	Fujii	D23/364

DESCRIPTION

FIG. 1 is a perspective view of an air purifier showing my new design;

FIG. 2 is a front view thereof;

FIG. 3 is a rear view thereof;

FIG. 4 is a right side view thereof;

FIG. 5 is a left side view thereof;

FIG. 6 is a top view thereof;

FIG. 7 is a bottom view thereof;

FIG. 8 is a sectional view thereof taken along line 8—8 in FIG. 2;

FIG. 9 is a perspective view of another air purifier showing my new design;

FIG. 10 is a front view thereof;

FIG. 11 is a rear view thereof;

FIG. 12 is a right side view thereof;

FIG. 13 is a left side view thereof;

FIG. 14 is a top view thereof; and,

FIG. 15 is a bottom view thereof.

1 Claim, 8 Drawing Sheets

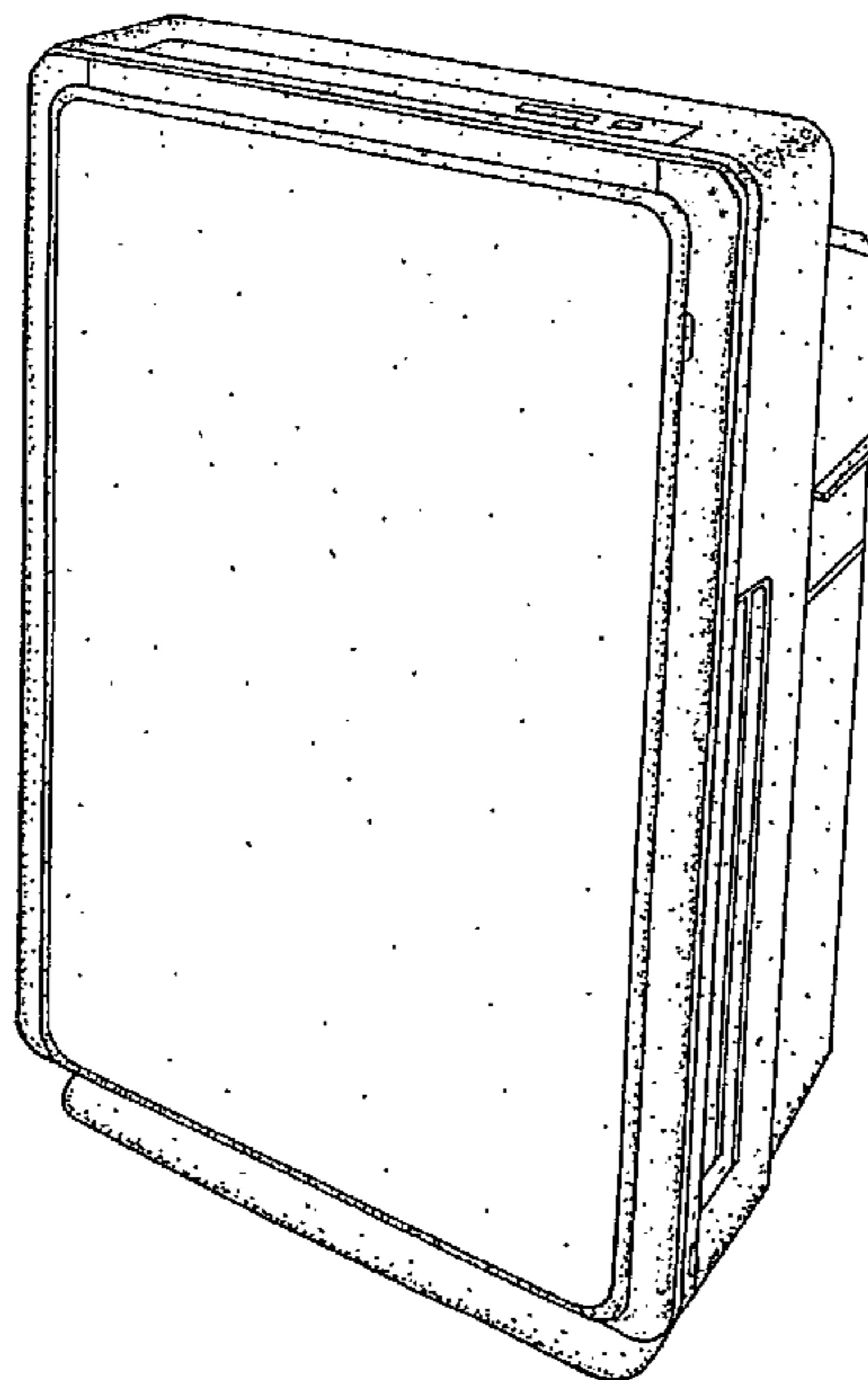

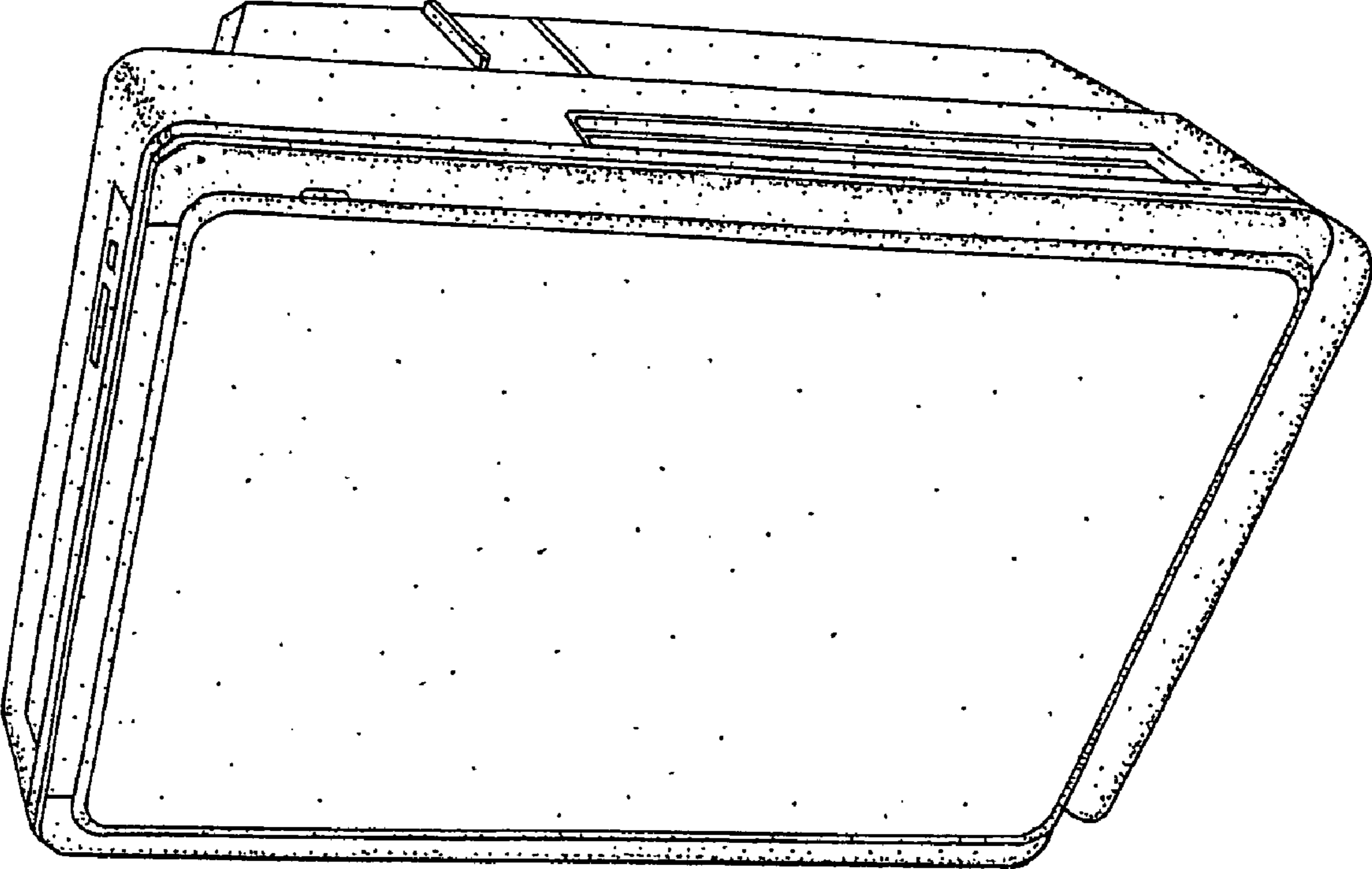

Fig. 1

Fig. 3

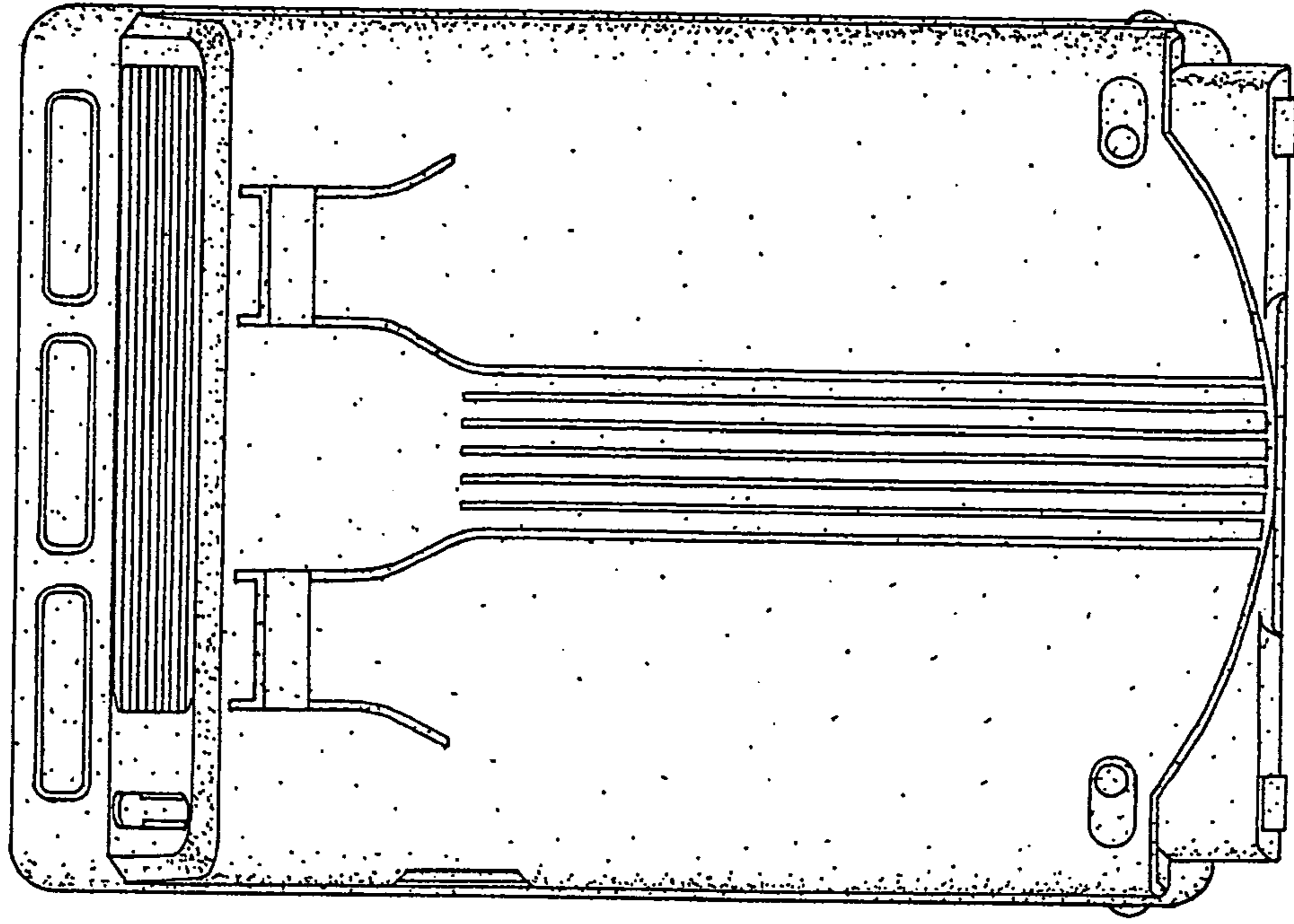

Fig. 2

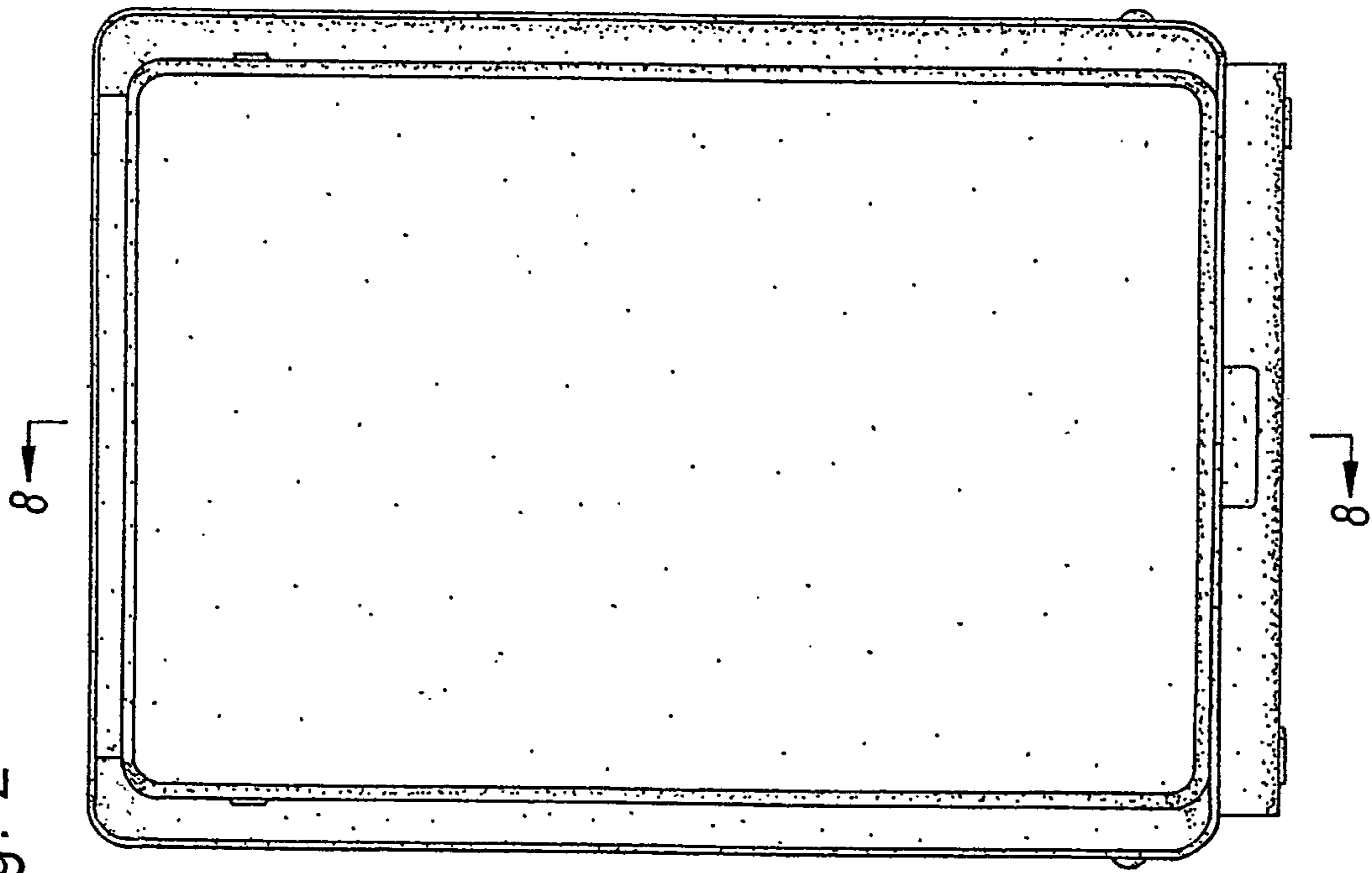

Fig. 5

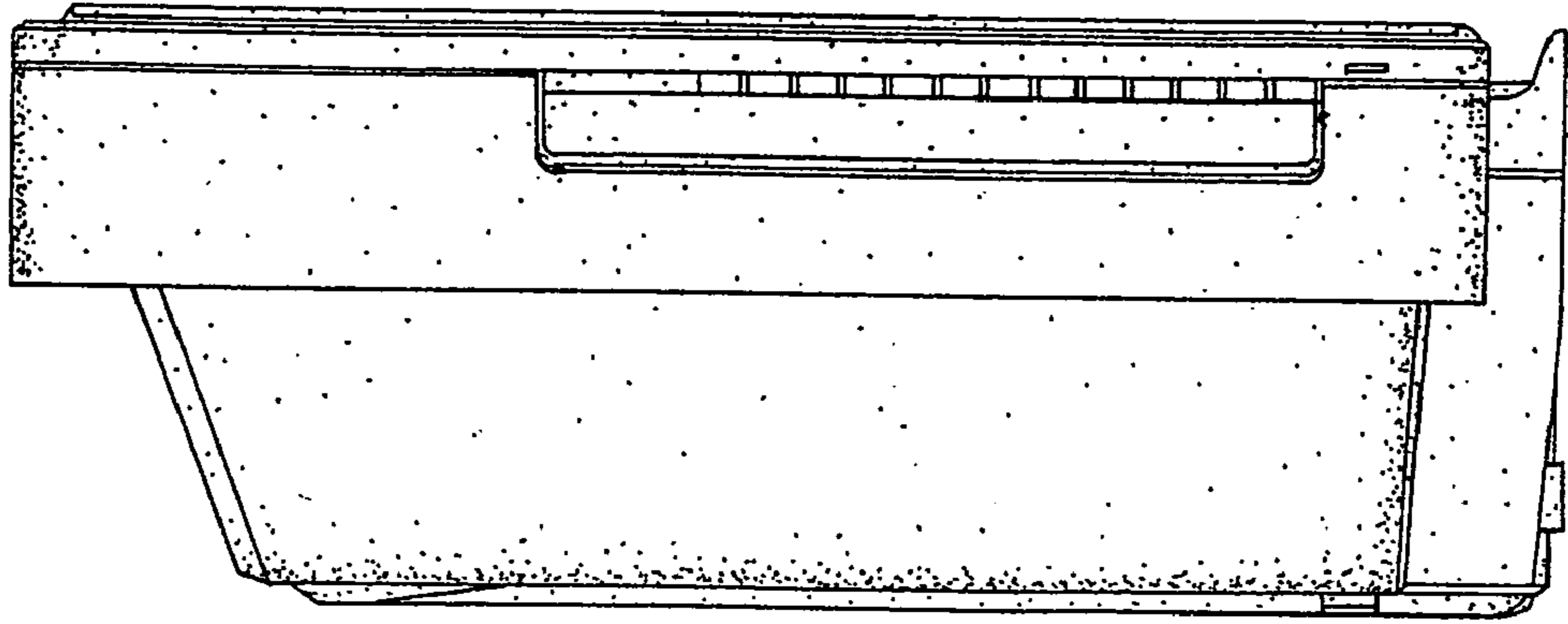

Fig. 4

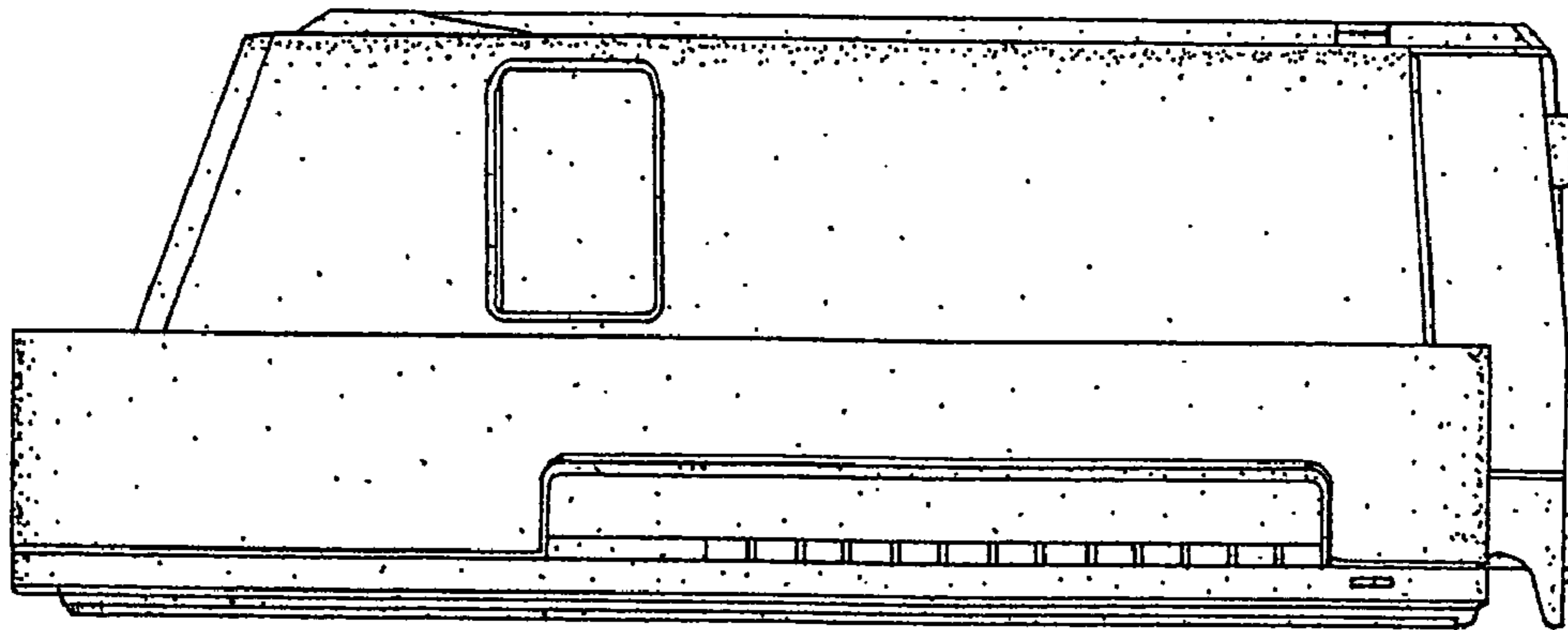

Fig. 8

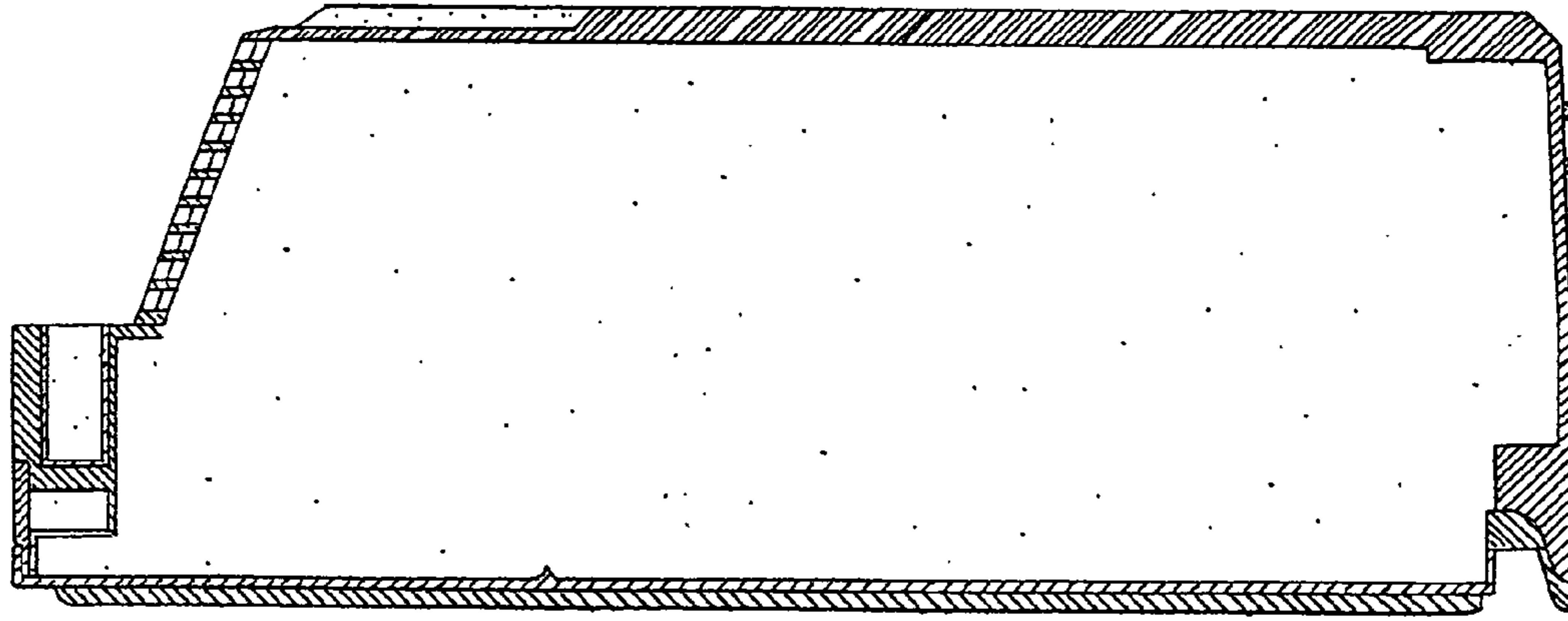

Fig. 6

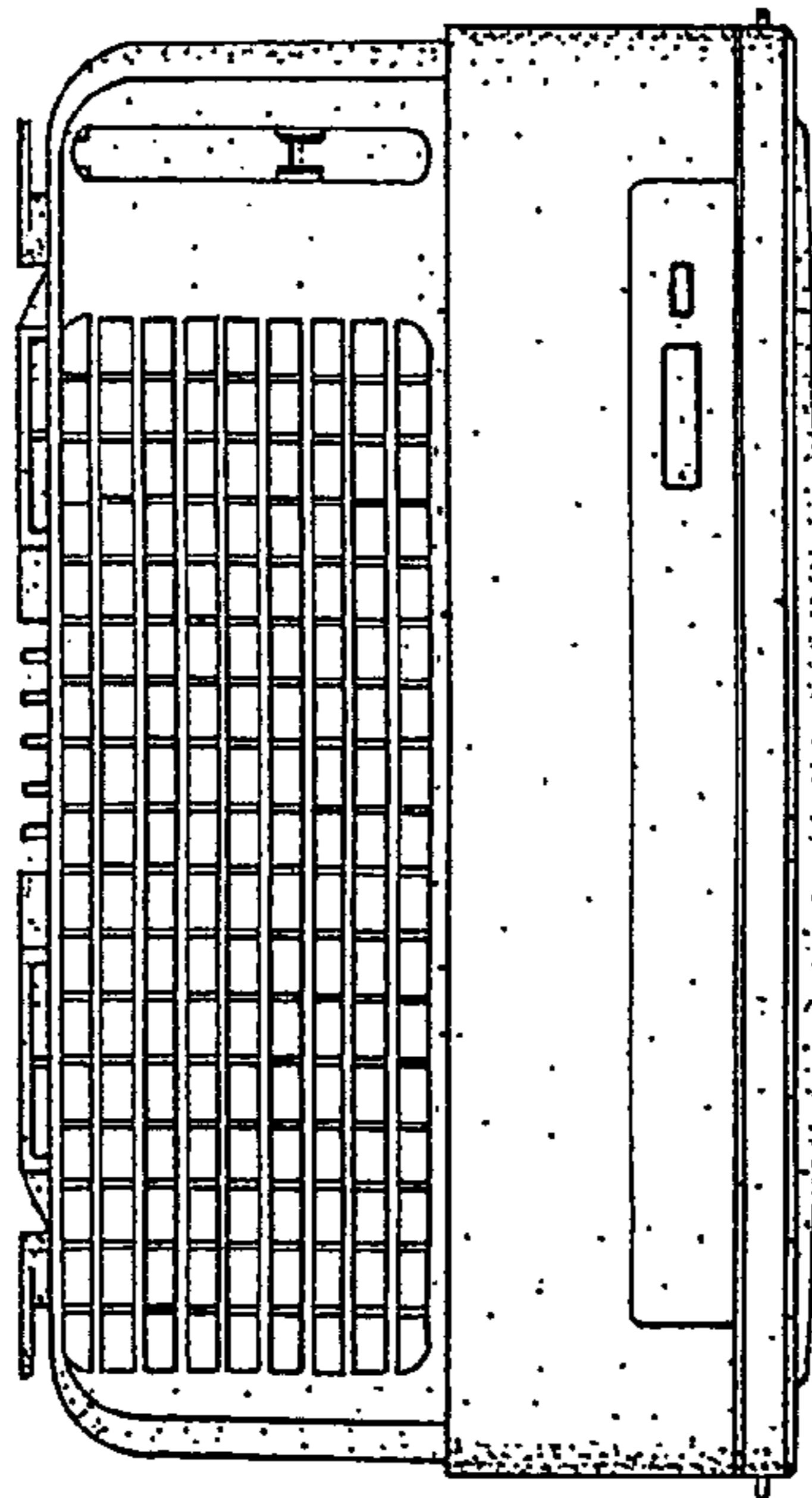
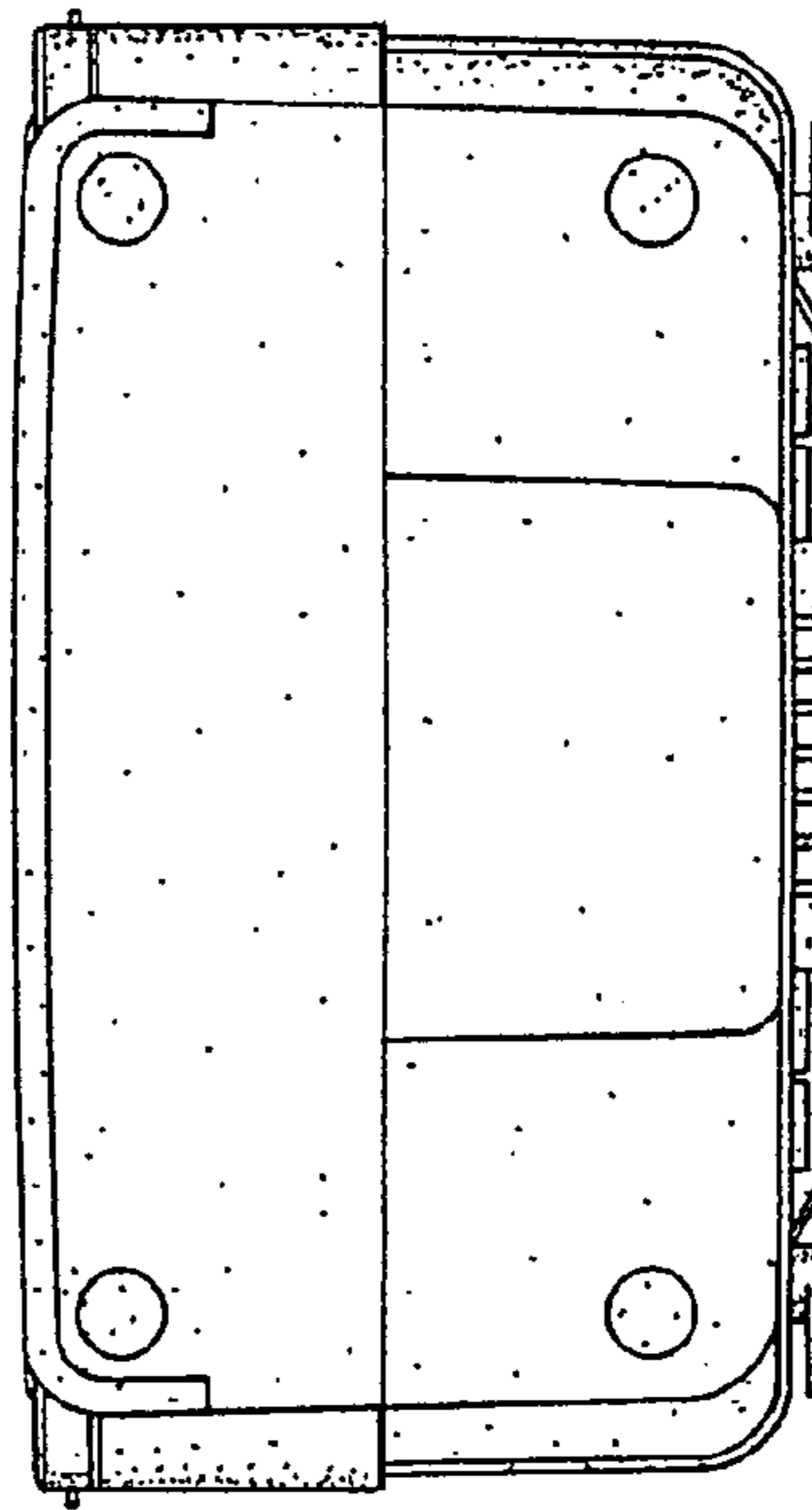

Fig. 7



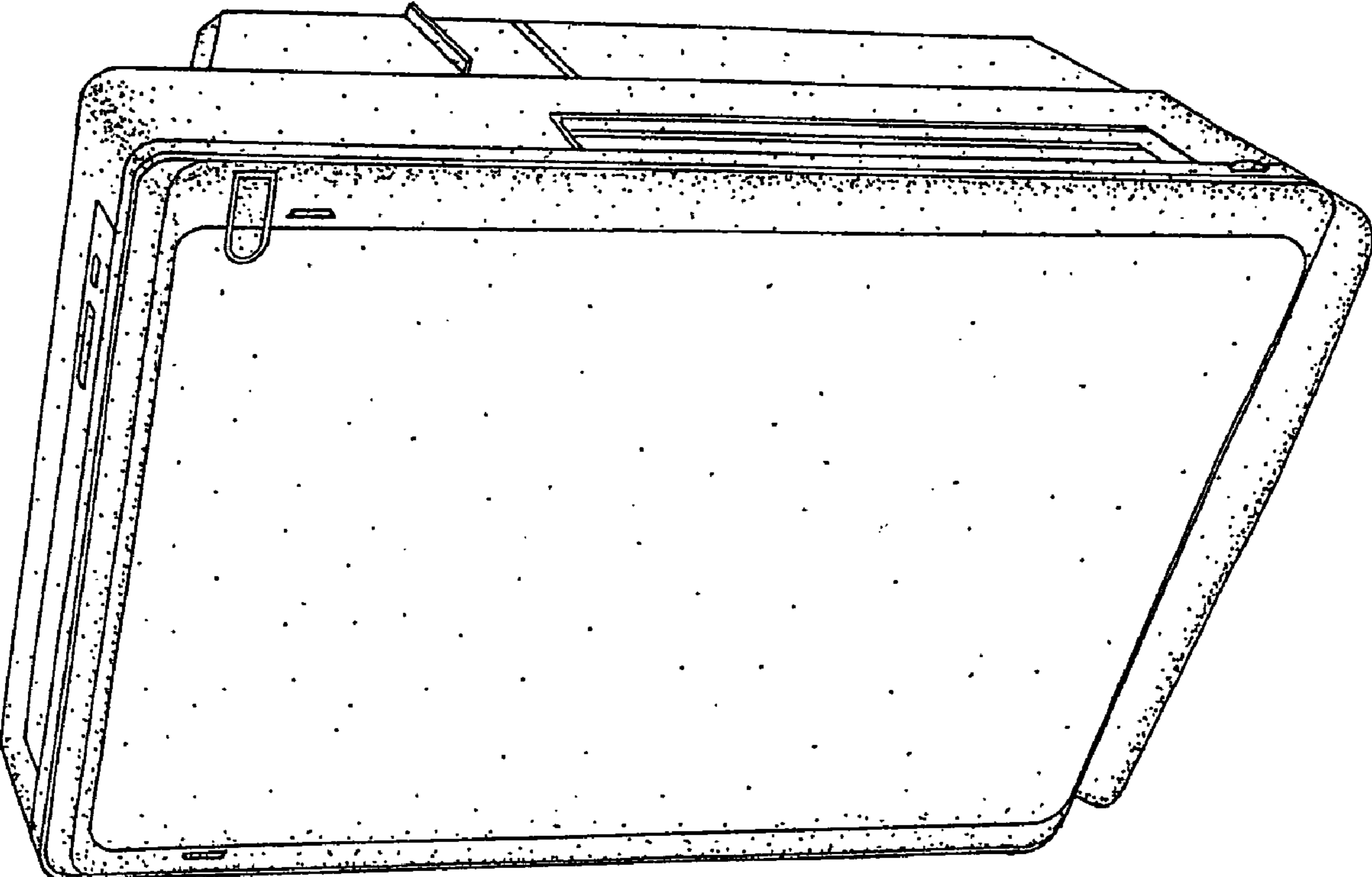

Fig. 9

Fig. 11

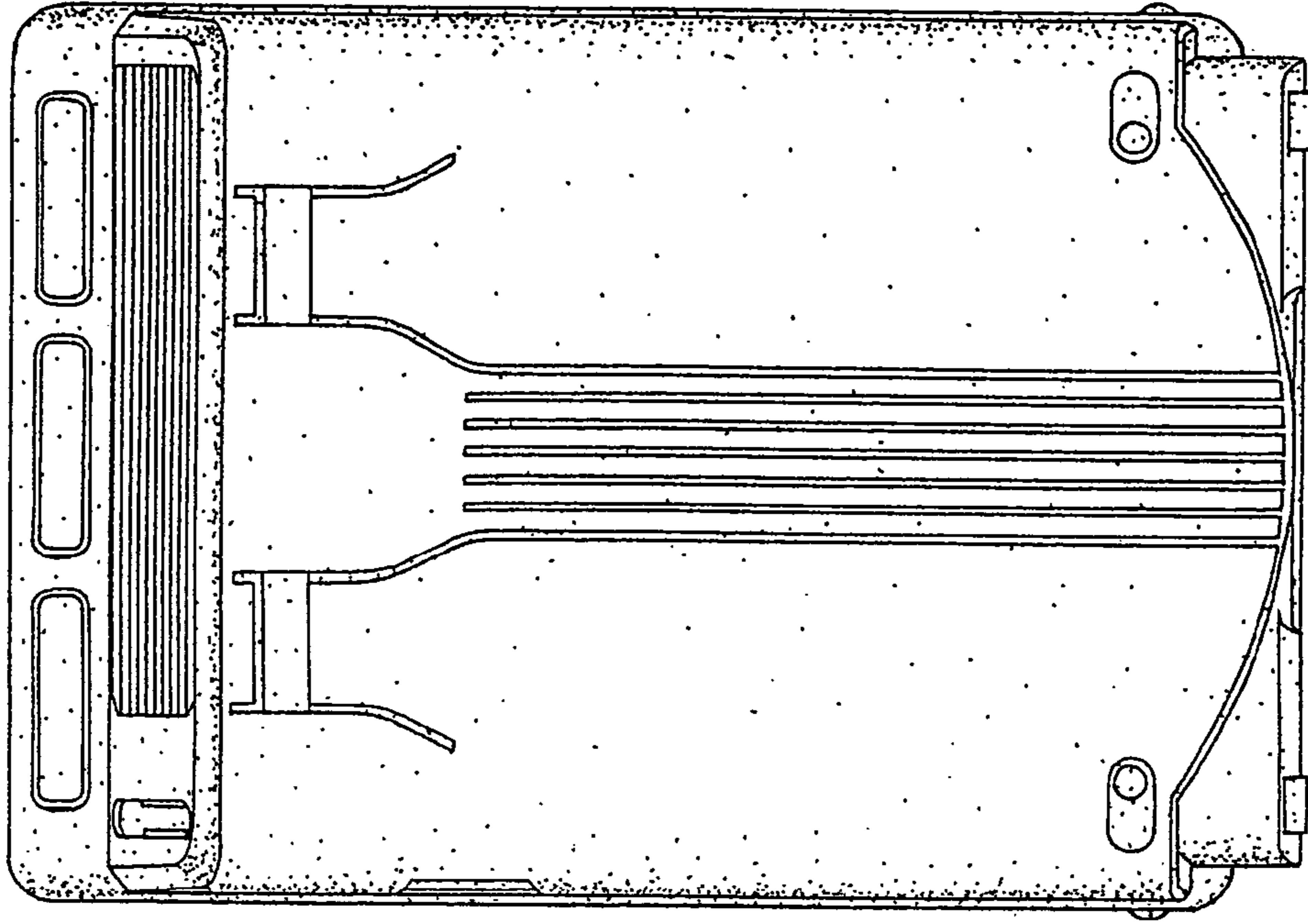

Fig. 10

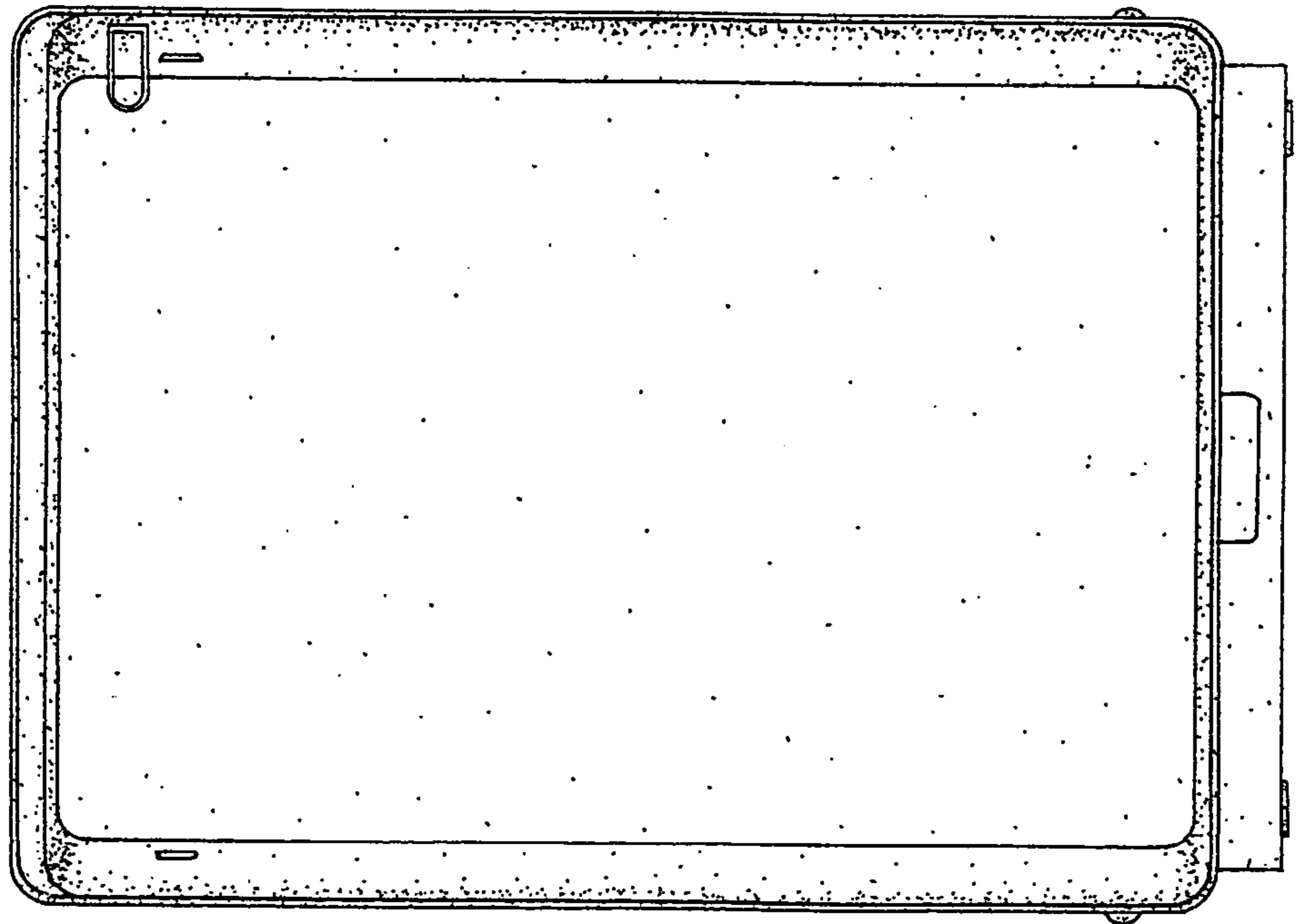

Fig. 13

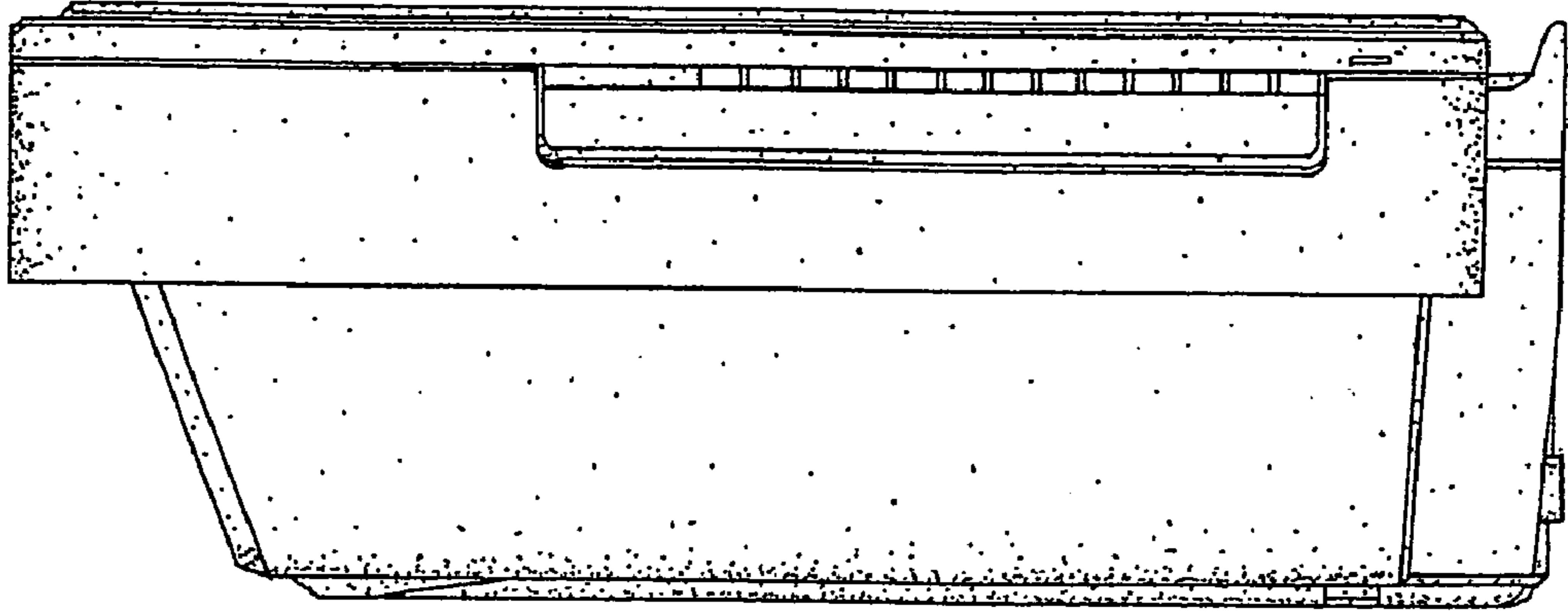

Fig. 12

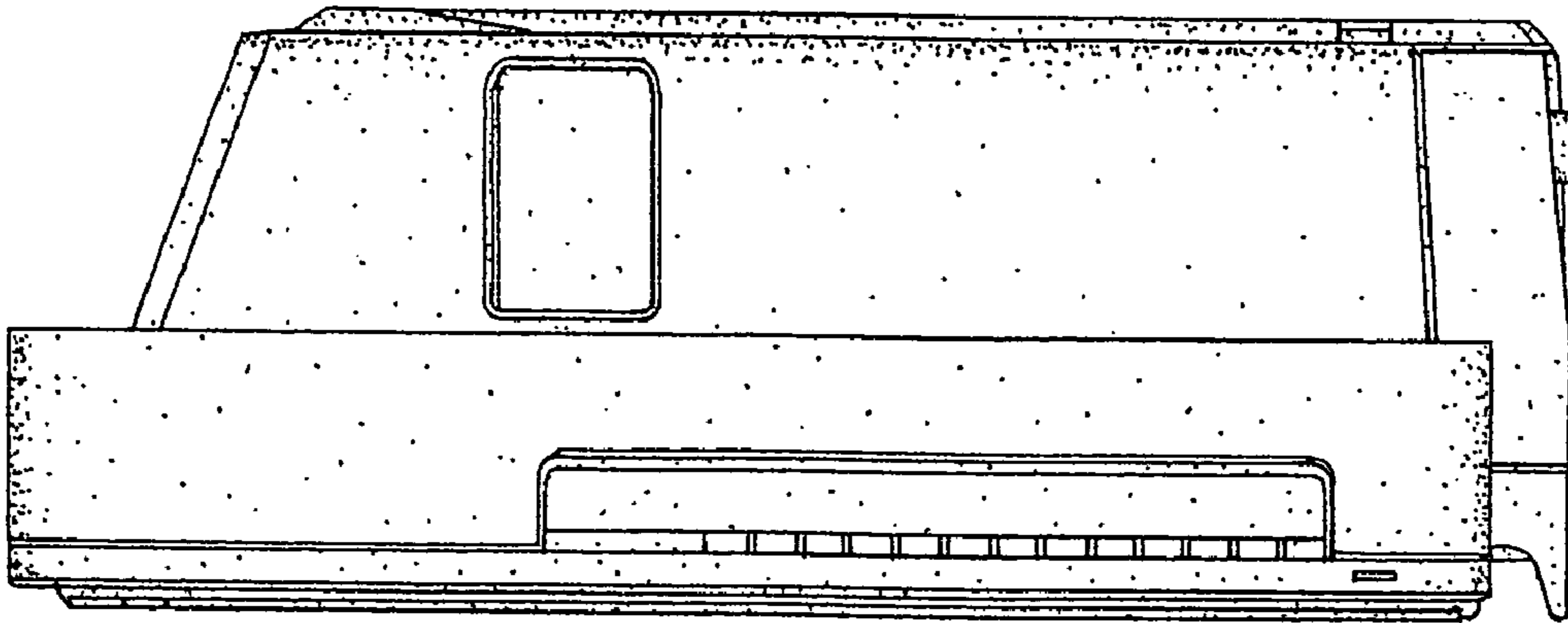

Fig. 14

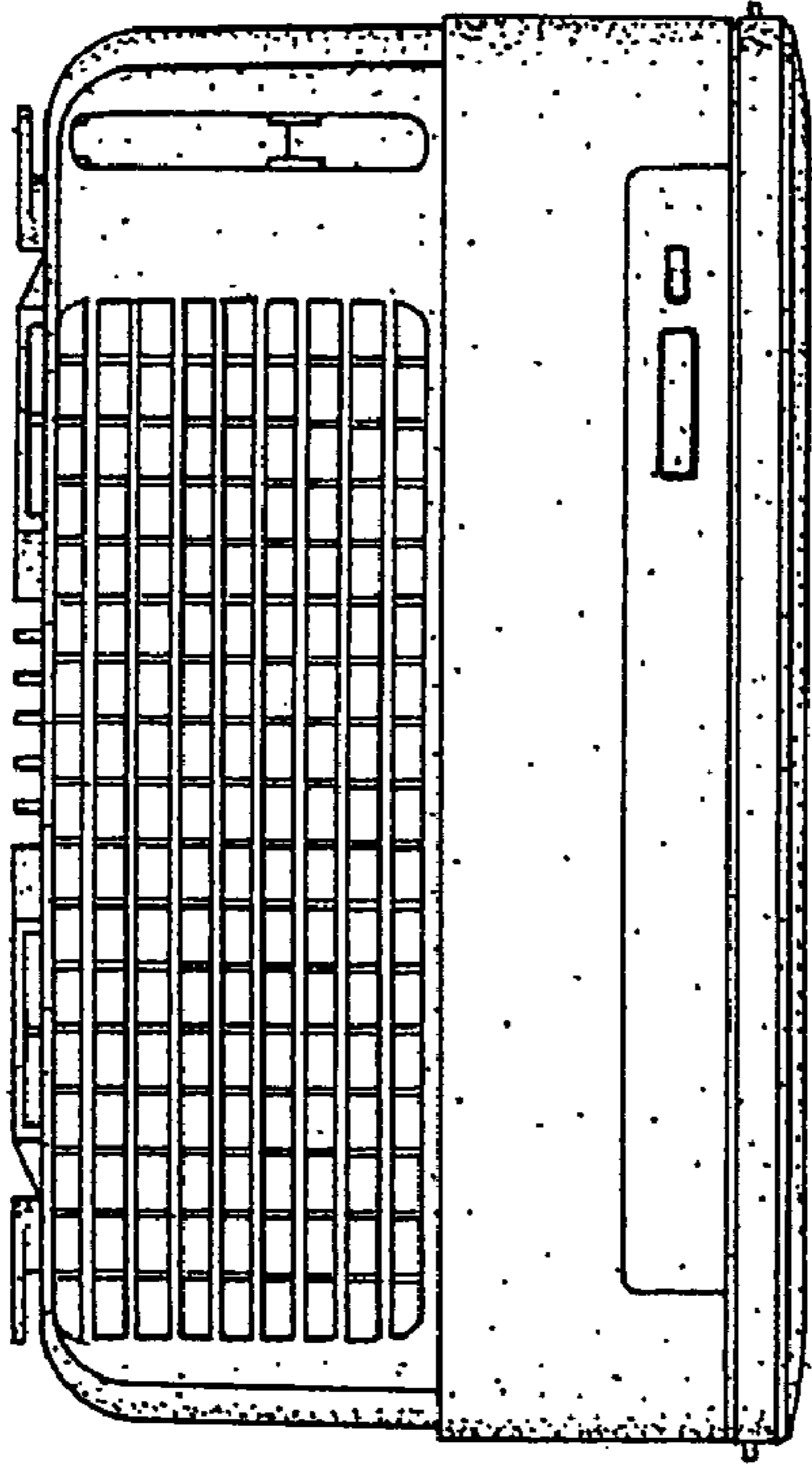

Fig. 15

