



US00D550810S

(12) **United States Design Patent**  
**Lammel**

(10) **Patent No.:** **US D550,810 S**

(45) **Date of Patent:** **\*\* Sep. 11, 2007**

(54) **SHOWER HEAD**

D440,630 S \* 4/2001 Gottwald ..... D23/223  
D503,775 S \* 4/2005 Zieger ..... D23/223  
D516,671 S \* 3/2006 Wu et al. .... D23/223

(75) Inventor: **Michael Lammel**, Aachen (DE)

(73) Assignee: **Hansa Metallwerke AG**, Stuttgart (DE)

\* cited by examiner

(\*\*) Term: **14 Years**

*Primary Examiner*—Robin V. Webster  
(74) *Attorney, Agent, or Firm*—Factor & Lake, Ltd.

(21) Appl. No.: **29/265,300**

(22) Filed: **Aug. 29, 2006**

(57) **CLAIM**

The ornamental design for a shower head, as shown.

(30) **Foreign Application Priority Data**

Mar. 1, 2006 (EM) .... 000487137-0001-0002-0003

**DESCRIPTION**

(51) **LOC (8) Cl.** ..... **23-01**

(52) **U.S. Cl.** ..... **D23/223**

(58) **Field of Classification Search** ..... D23/213,  
D23/223, 226; 239/394, 605, 615

See application file for complete search history.

FIG. 1 is a perspective view of the shower head, showing a new ornamental design thereof;

FIG. 2 is a left hand view thereof;

FIG. 3 is a right hand view thereof;

FIG. 4 is front view thereof;

FIG. 5 is a rear view thereof;

FIG. 6 is a top view thereof; and,

FIG. 7 is a bottom view thereof.

(56) **References Cited**

**U.S. PATENT DOCUMENTS**

D339,627 S \* 9/1993 Klose ..... D23/223  
D424,163 S \* 5/2000 Haug et al. .... D23/223

**1 Claim, 7 Drawing Sheets**

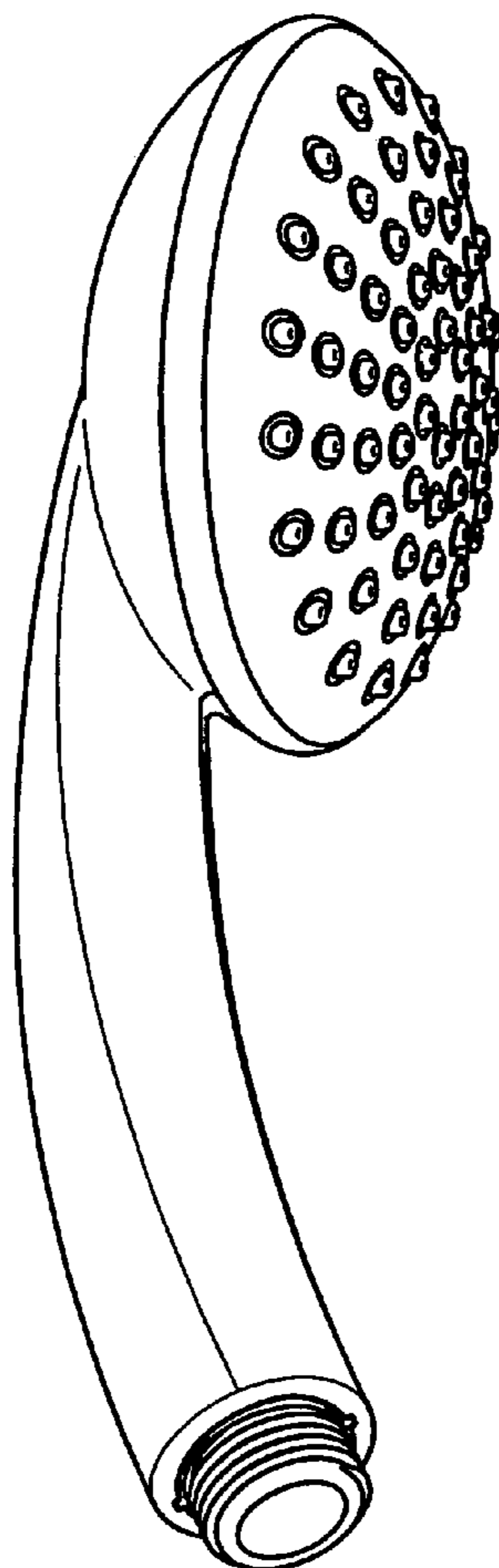

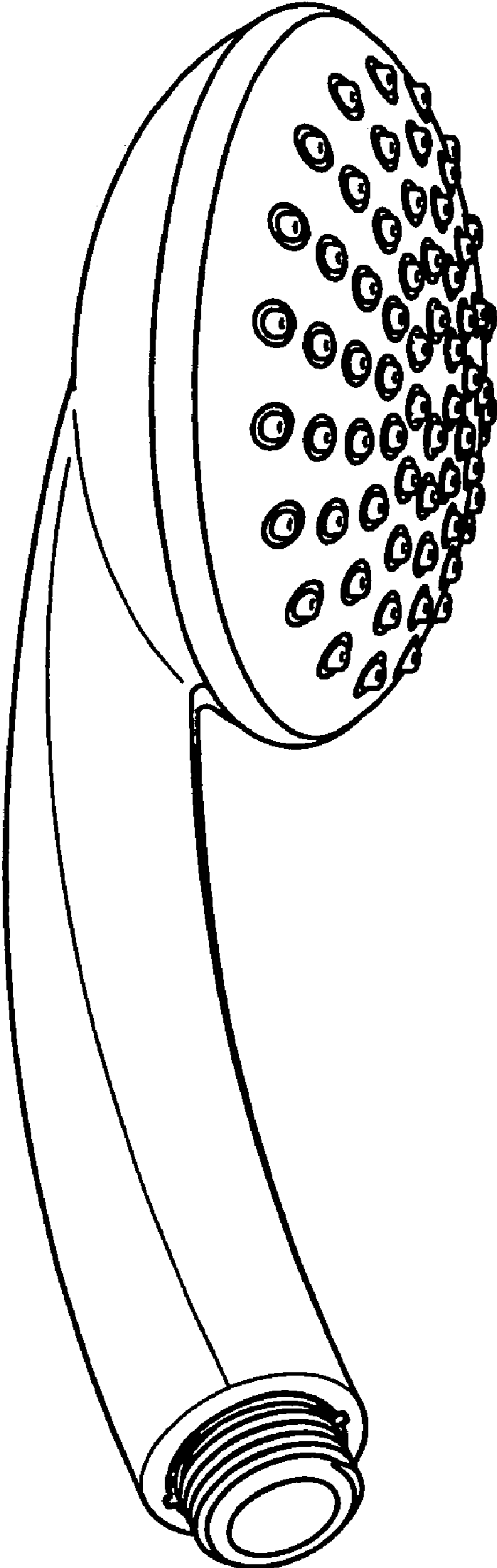

**FIG. 1**

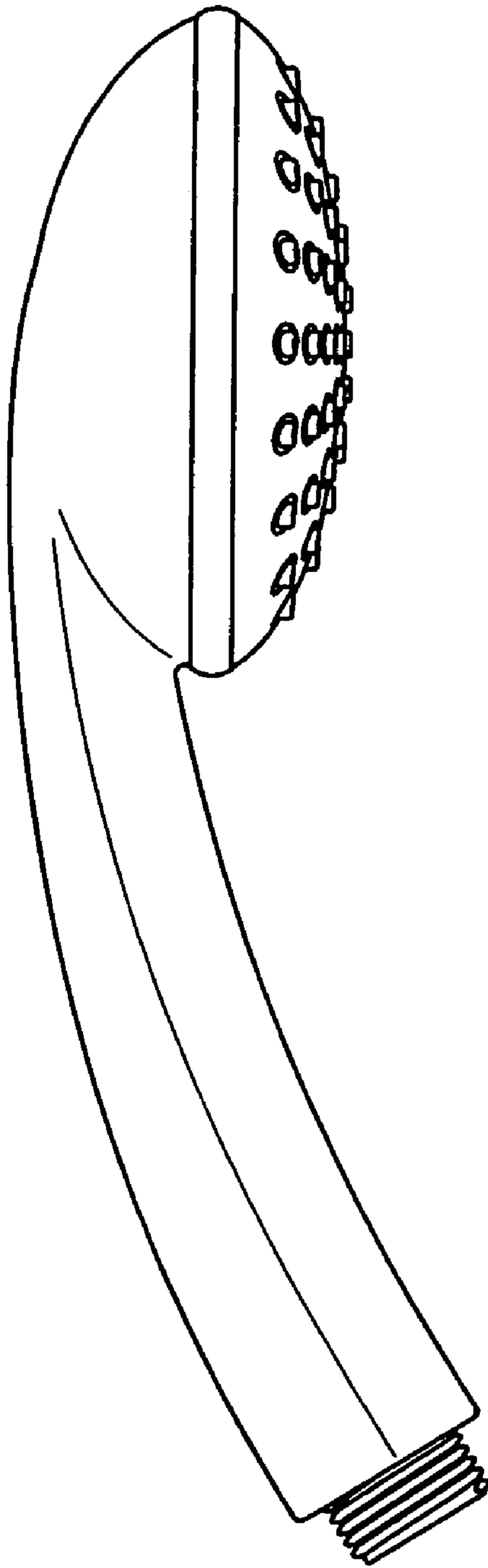

**FIG. 2**



**FIG. 3**

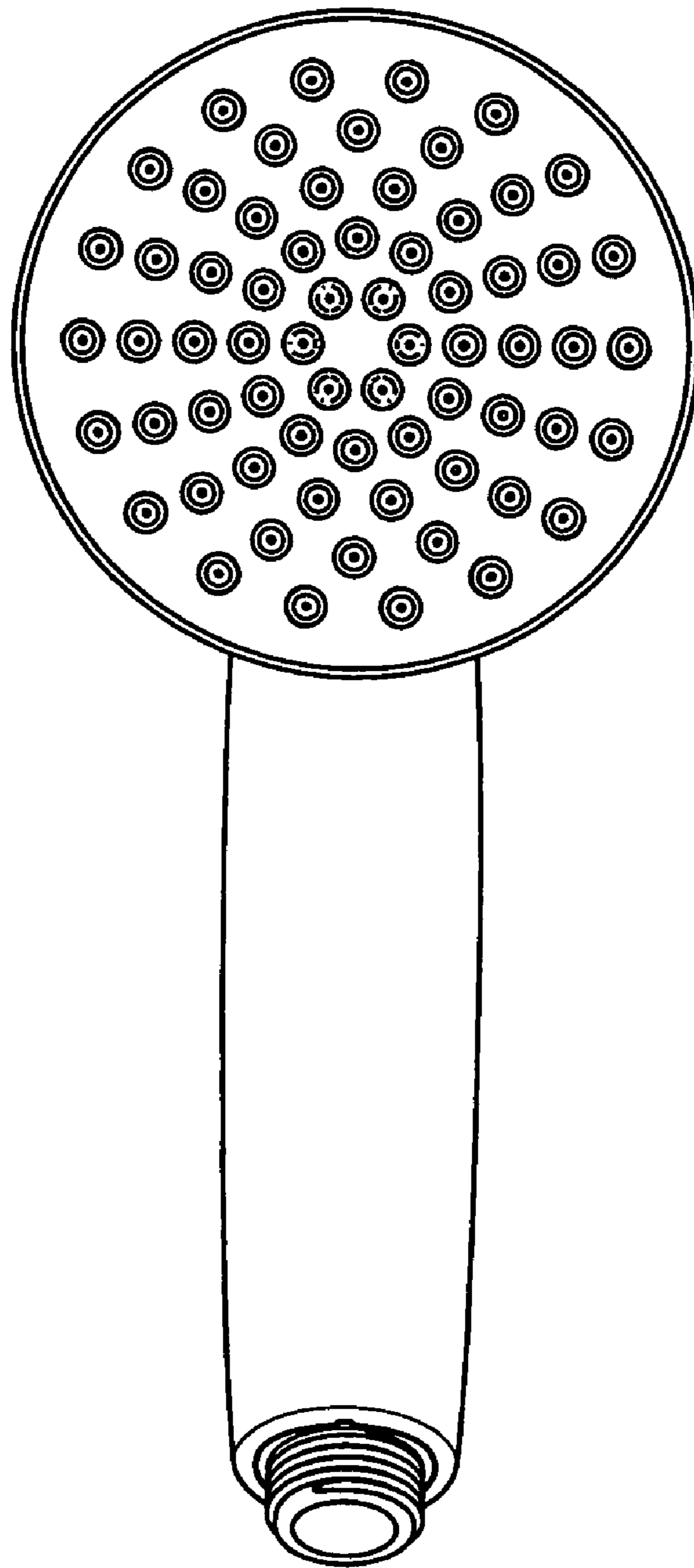

**FIG. 4**

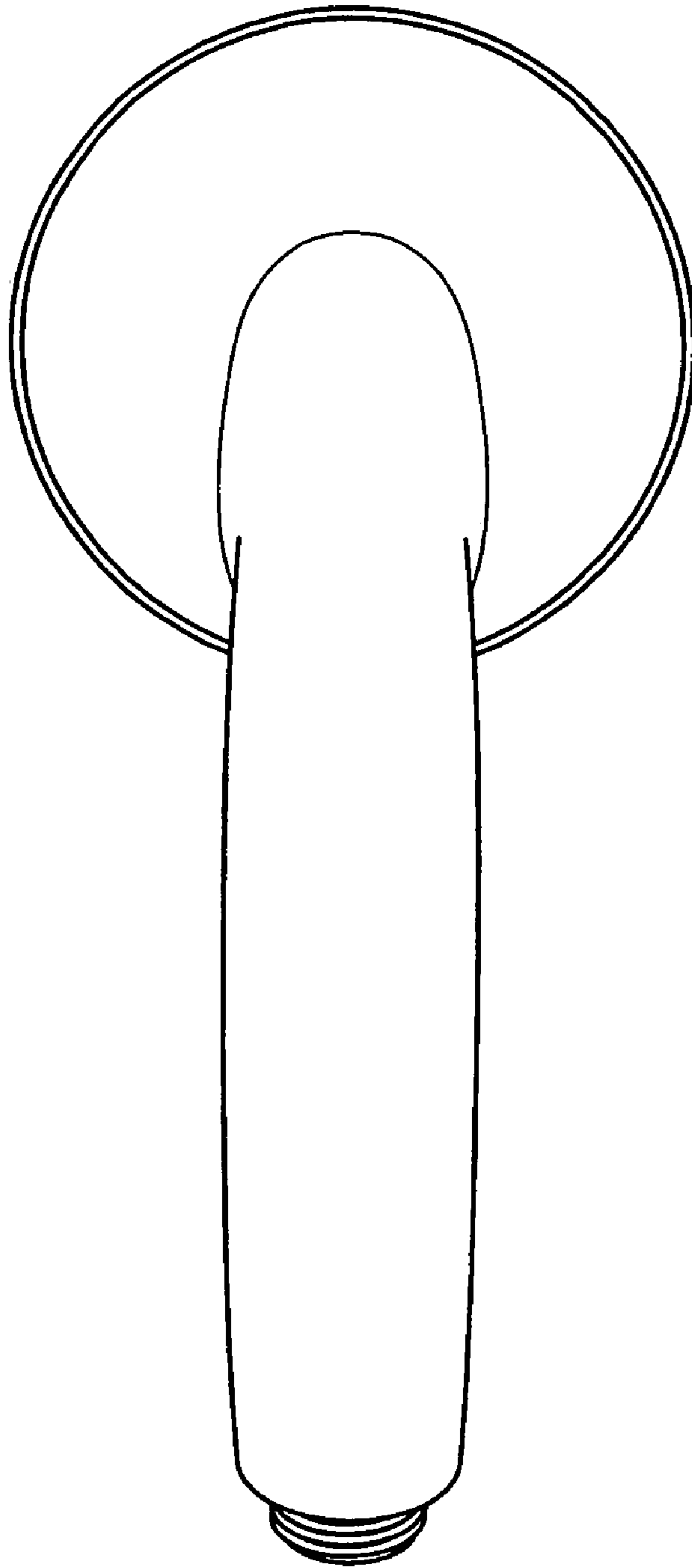

**FIG. 5**

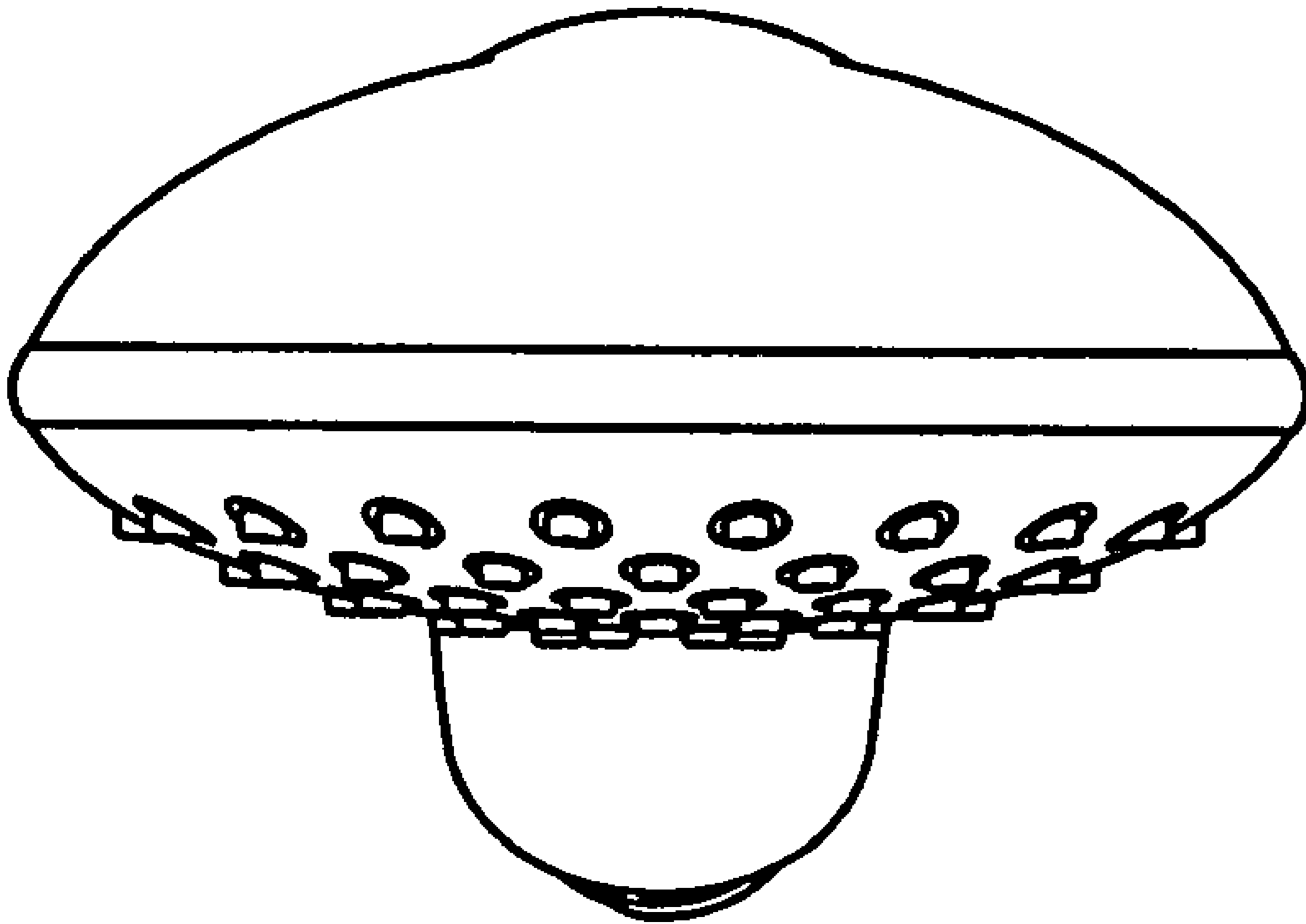

**FIG. 6**

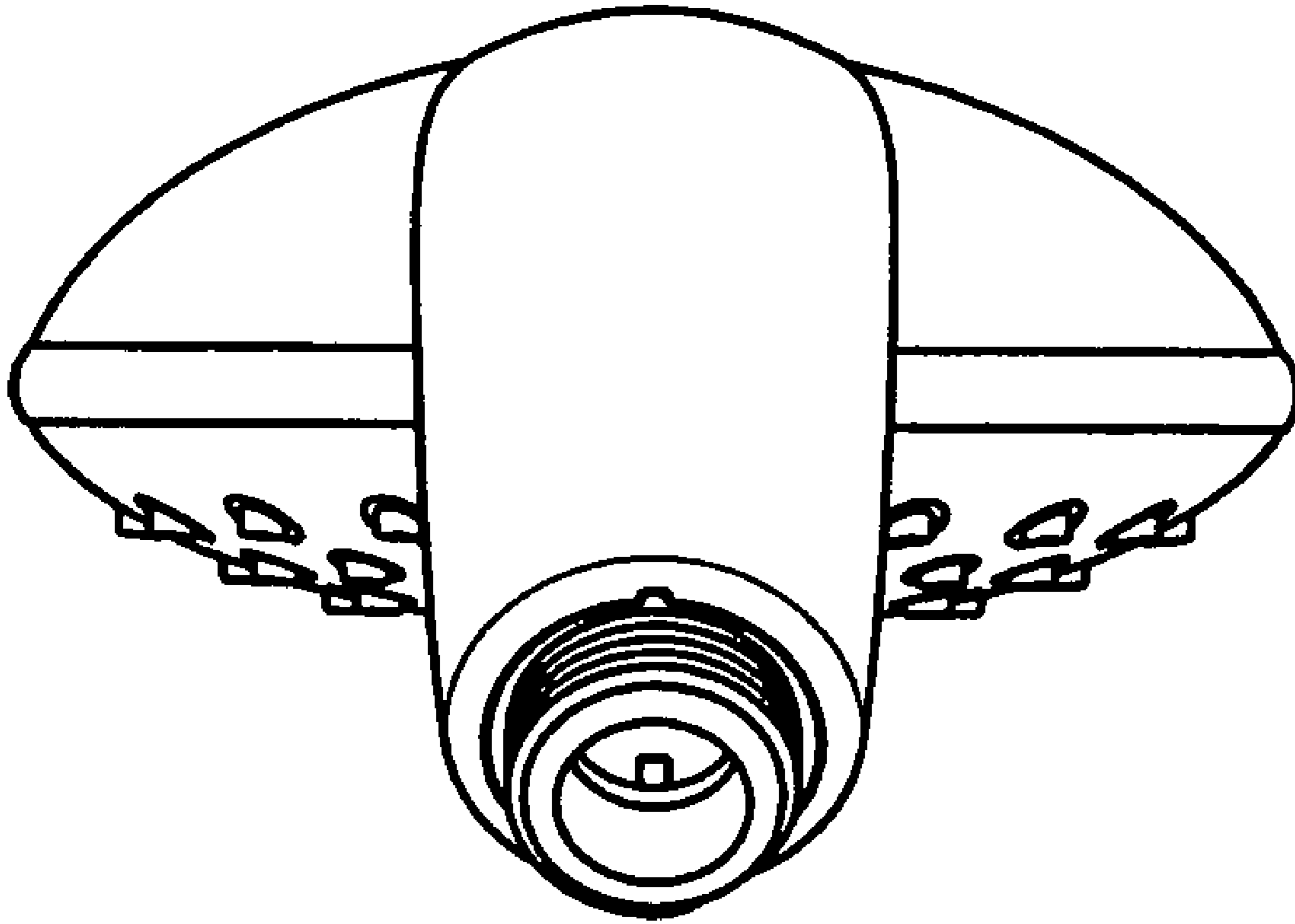

**FIG. 7**