

US00D550809S

(12) **United States Design Patent**
Lammel

(10) **Patent No.:** **US D550,809 S**

(45) **Date of Patent:** **** Sep. 11, 2007**

(54) **SHOWER HEAD**

(75) Inventor: **Michael Lammel**, Aachen (DE)

(73) Assignee: **Hansa Metallwerke AG**, Stuttgart (DE)

(**) Term: **14 Years**

(21) Appl. No.: **29/265,287**

(22) Filed: **Aug. 29, 2006**

(30) **Foreign Application Priority Data**

Mar. 1, 2006 (EM) 000487137-0001-0002-003

(51) **LOC (8) Cl.** **23-01**

(52) **U.S. Cl.** **D23/223**

(58) **Field of Classification Search** D23/213,
D23/223, 226; 239/394, 282-283; 4/605,
4/615

See application file for complete search history.

(56) **References Cited**

U.S. PATENT DOCUMENTS

D339,627 S * 9/1993 Klose D23/223

D424,163 S * 5/2000 Haug et al. D23/223
D440,630 S * 4/2001 Gottwald D23/223
D503,775 S * 4/2005 Zieger D23/223
D516,671 S * 3/2006 Wu et al. D23/223

* cited by examiner

Primary Examiner—Robin V. Webster

(74) *Attorney, Agent, or Firm*—Factor & Lake, Ltd.

(57) **CLAIM**

The ornamental design for a shower head, as shown.

DESCRIPTION

FIG. 1 is a perspective view of the shower head, showing a new ornamental design thereof;

FIG. 2 is a left hand view thereof;

FIG. 3 is a right hand view thereof;

FIG. 4 is front view thereof;

FIG. 5 is a rear view thereof;

FIG. 6 is a top view thereof; and,

FIG. 7 is a bottom view thereof.

1 Claim, 7 Drawing Sheets

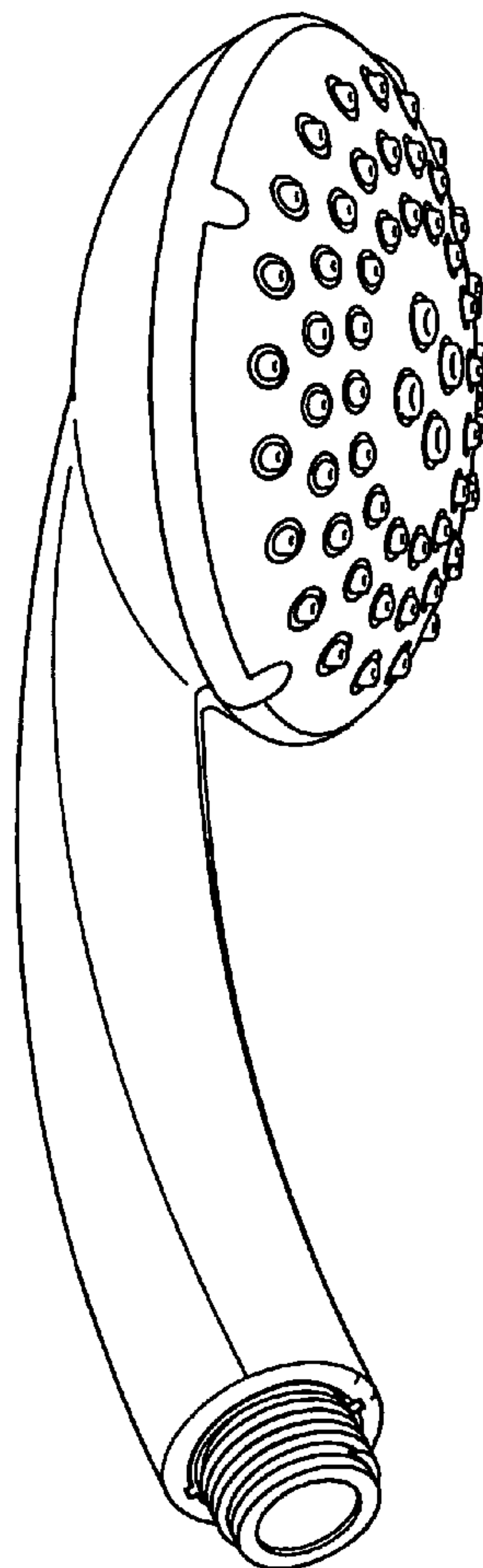

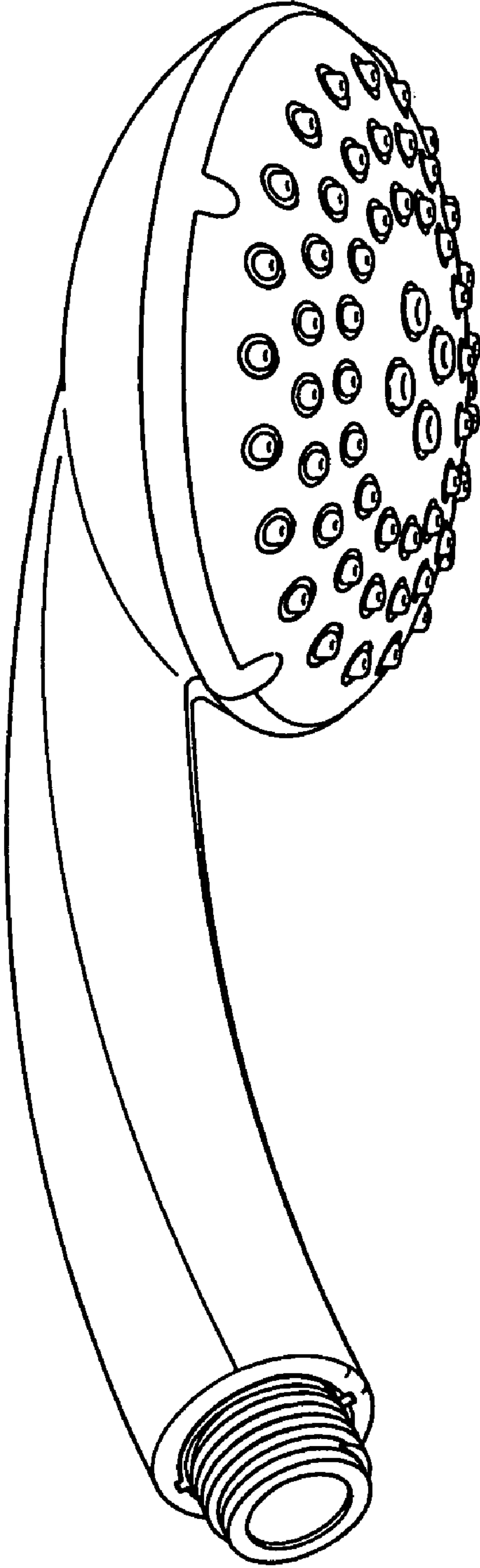

FIG. 1

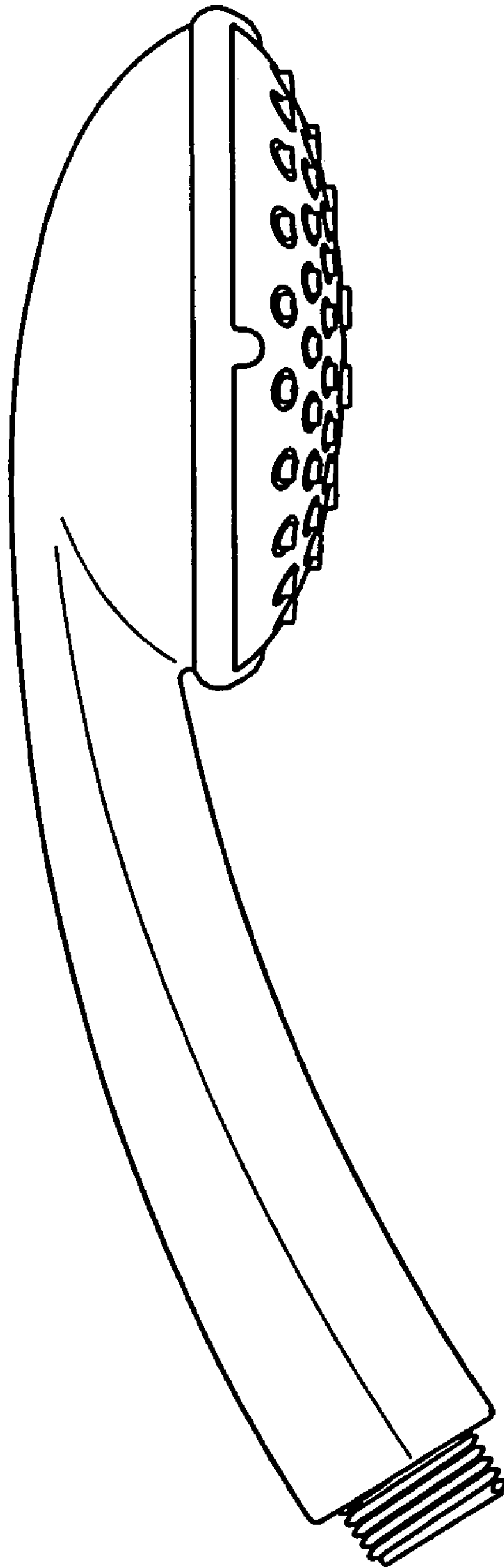

FIG. 2

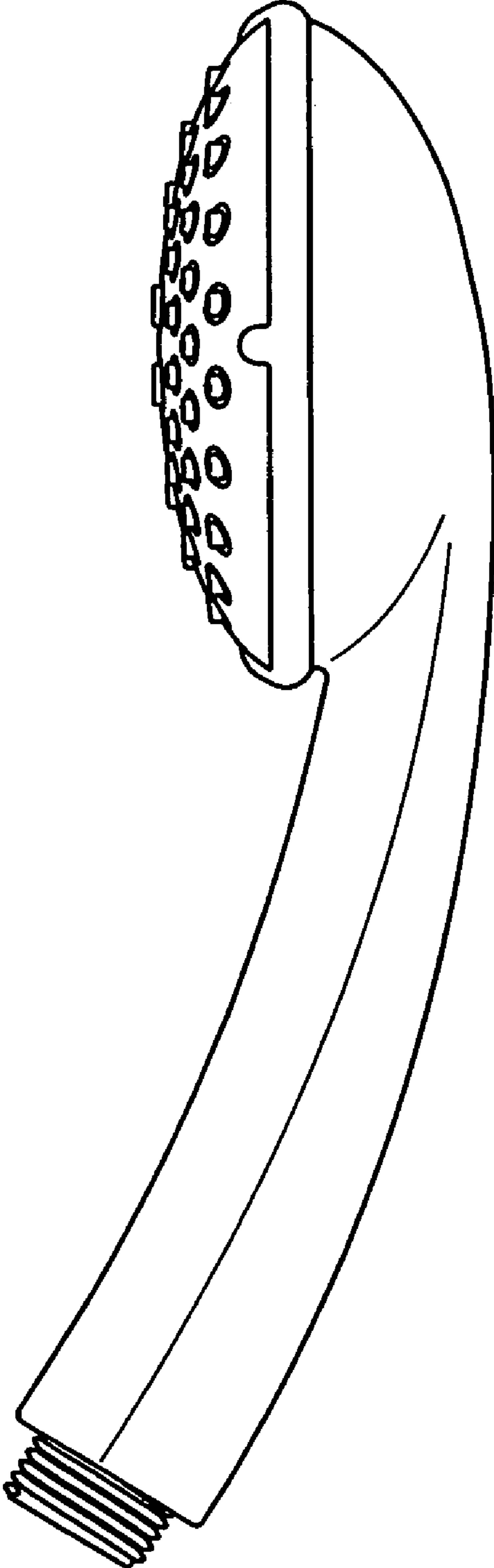

FIG. 3

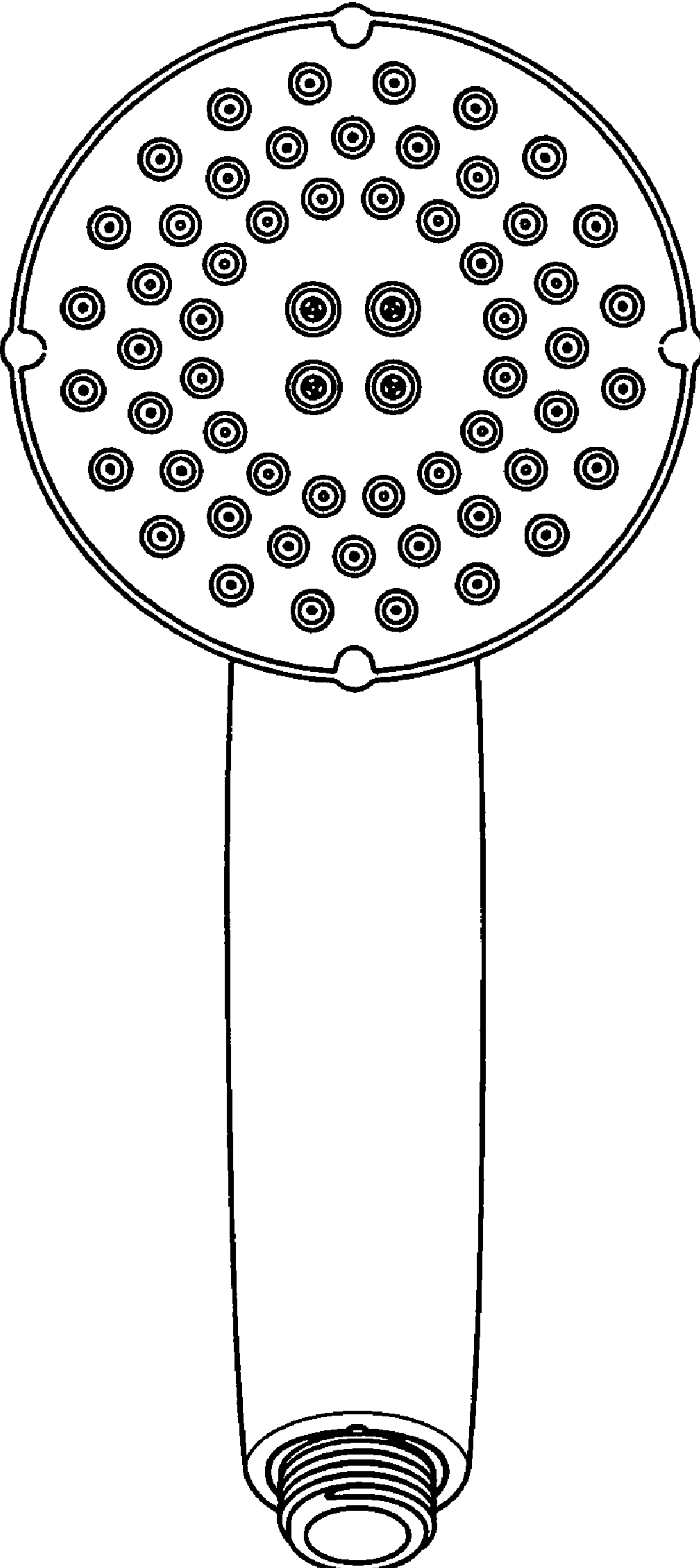

FIG. 4

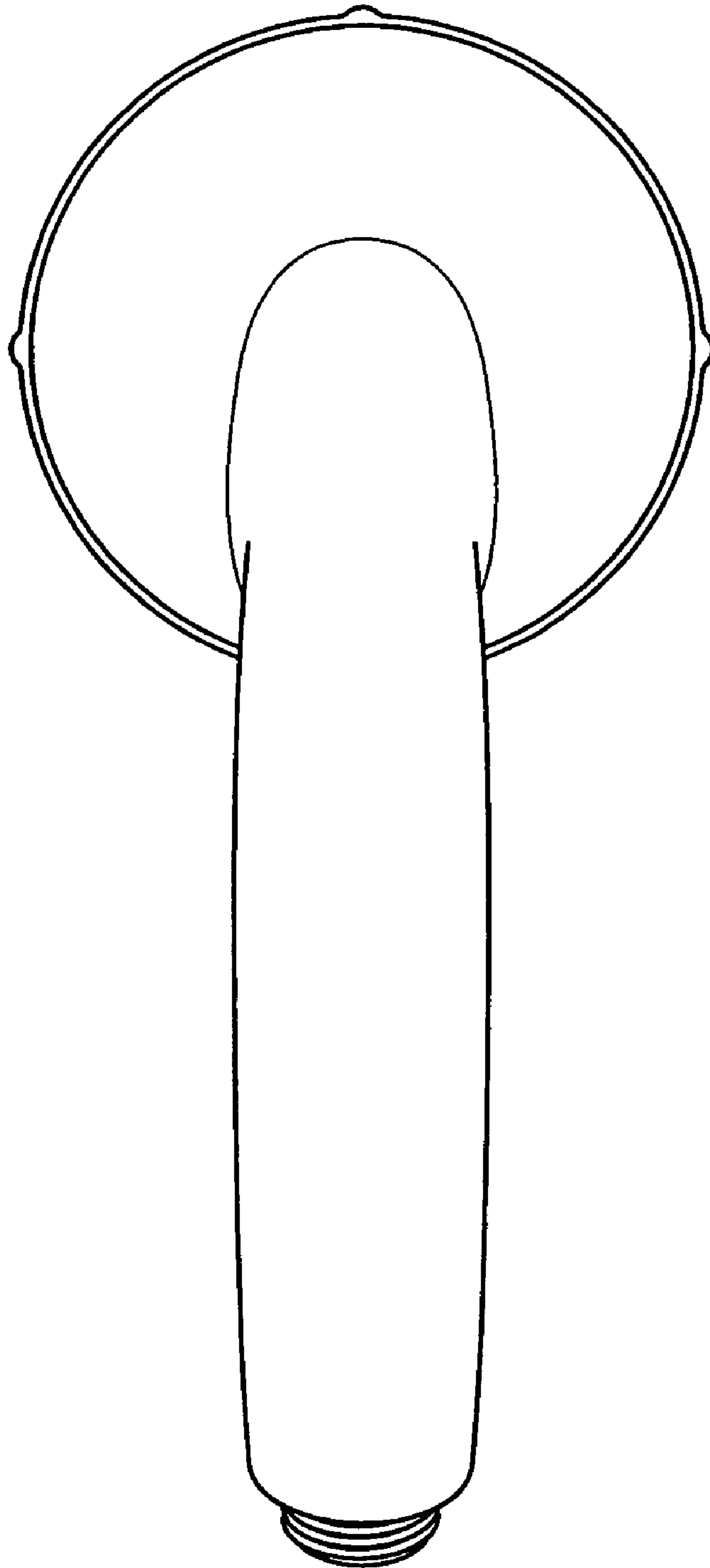

FIG. 5

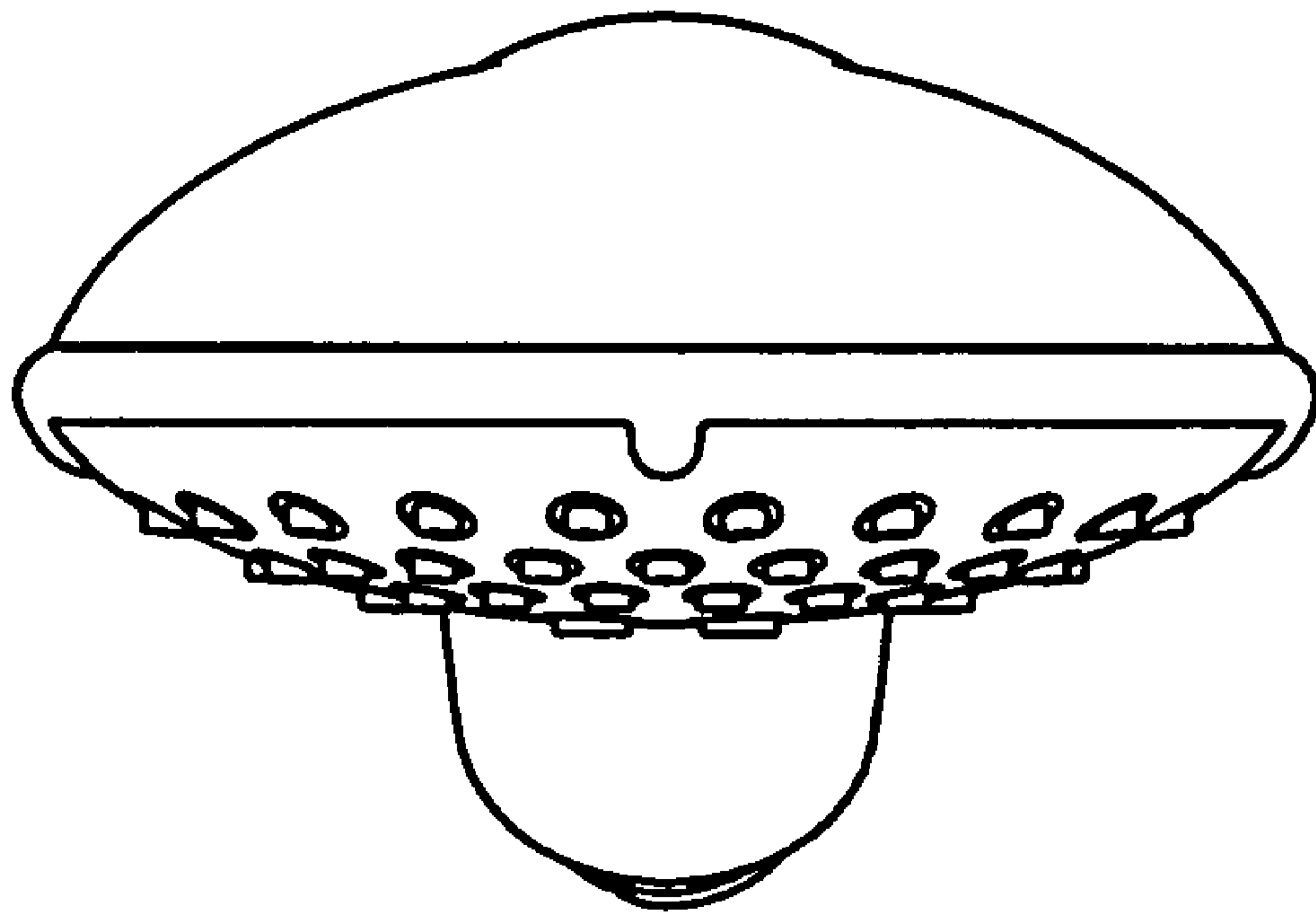

FIG. 6

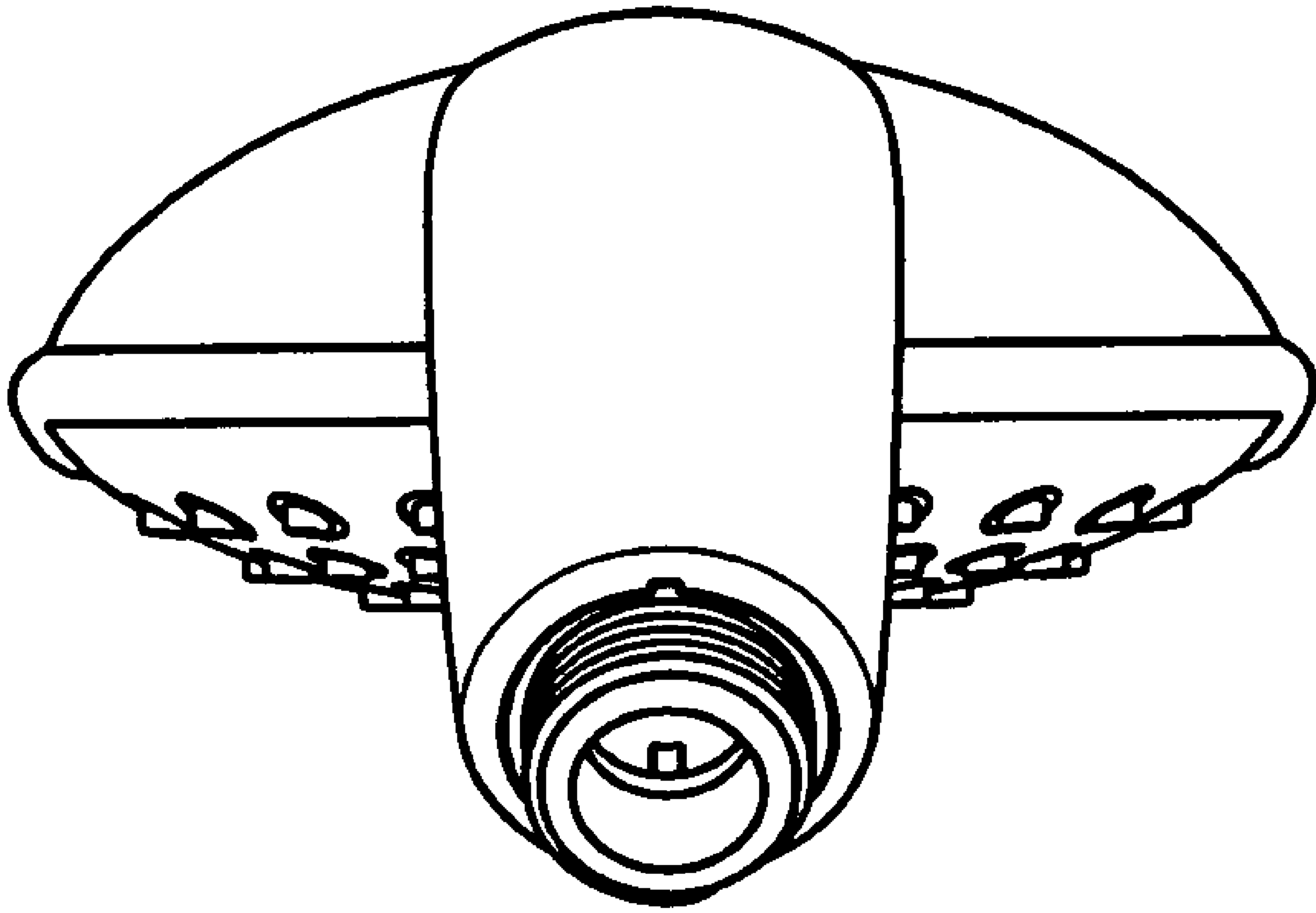

FIG. 7