



US00D550774S

(12) **United States Design Patent**
Kinugasa et al.

(10) **Patent No.:** **US D550,774 S**

(45) **Date of Patent:** **** Sep. 11, 2007**

(54) **COATING FILM TRANSFER TOOL**

(75) Inventors: **Shuji Kinugasa**, Osaka (JP); **Hideto Shima**, Yawata (JP)

(73) Assignee: **Kokuyo S & T Co., Ltd.** (JP)

(**) Term: **14 Years**

(21) Appl. No.: **29/239,240**

(22) Filed: **Sep. 28, 2005**

(30) **Foreign Application Priority Data**

Apr. 12, 2005 (JP) D2005-010887

(51) **LOC (8) Cl.** **19-02**

(52) **U.S. Cl.** **D19/69**

(58) **Field of Classification Search** D19/66,
D19/67, 68, 69, 70; 156/523, 257, 540, 577;
206/411; 225/6, 25, 39, 77; 242/588, 588.1,
242/588.2, 588.3, 588.6, 598.5

See application file for complete search history.

(56) **References Cited**

U.S. PATENT DOCUMENTS

- D420,389 S * 2/2000 Shimizu D19/69
- D424,619 S * 5/2000 Katami D19/69
- D433,449 S * 11/2000 Fujiwara D19/53
- D436,625 S * 1/2001 Katami D19/69
- D438,250 S * 2/2001 Katami D19/69
- D451,960 S * 12/2001 Shimizu D19/69
- D465,241 S * 11/2002 Suzuki D19/69

- D466,938 S * 12/2002 Lee D19/69
- 6,739,369 B2 * 5/2004 Watanabe 156/577
- D524,373 S * 7/2006 Kimura D19/69
- 2002/0033237 A1 * 3/2002 Narita et al. 156/577

FOREIGN PATENT DOCUMENTS

JP D1148002 7/2002

* cited by examiner

Primary Examiner—Cathron C. Brooks

Assistant Examiner—Austin Murphy

(74) *Attorney, Agent, or Firm*—Banner & Witcoff, Ltd.

(57) **CLAIM**

The ornamental design for a coating film transfer tool, as shown and described.

DESCRIPTION

FIG. 1 is a perspective view of a first embodiment coating film transfer tool showing our new design;

FIG. 2 is a front elevational view thereof;

FIG. 3 is a back elevational view thereof;

FIG. 4 is a left side elevational view thereof;

FIG. 5 is a right side elevational view thereof;

FIG. 6 is a top plan view thereof;

FIG. 7 is a bottom plan view thereof; and,

FIG. 8 is a perspective of the coating film transfer tool shown in a position of use.

1 Claim, 4 Drawing Sheets

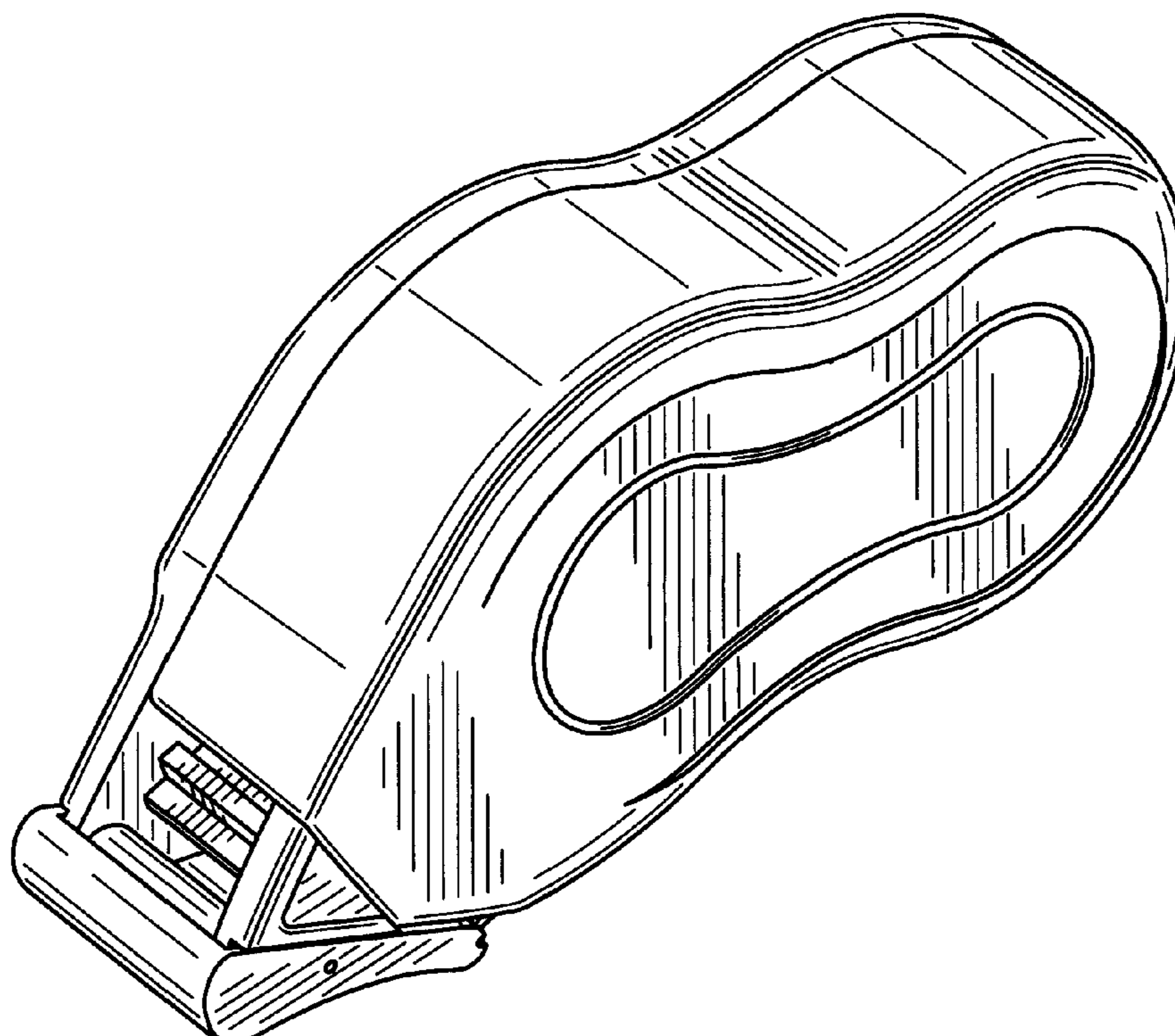

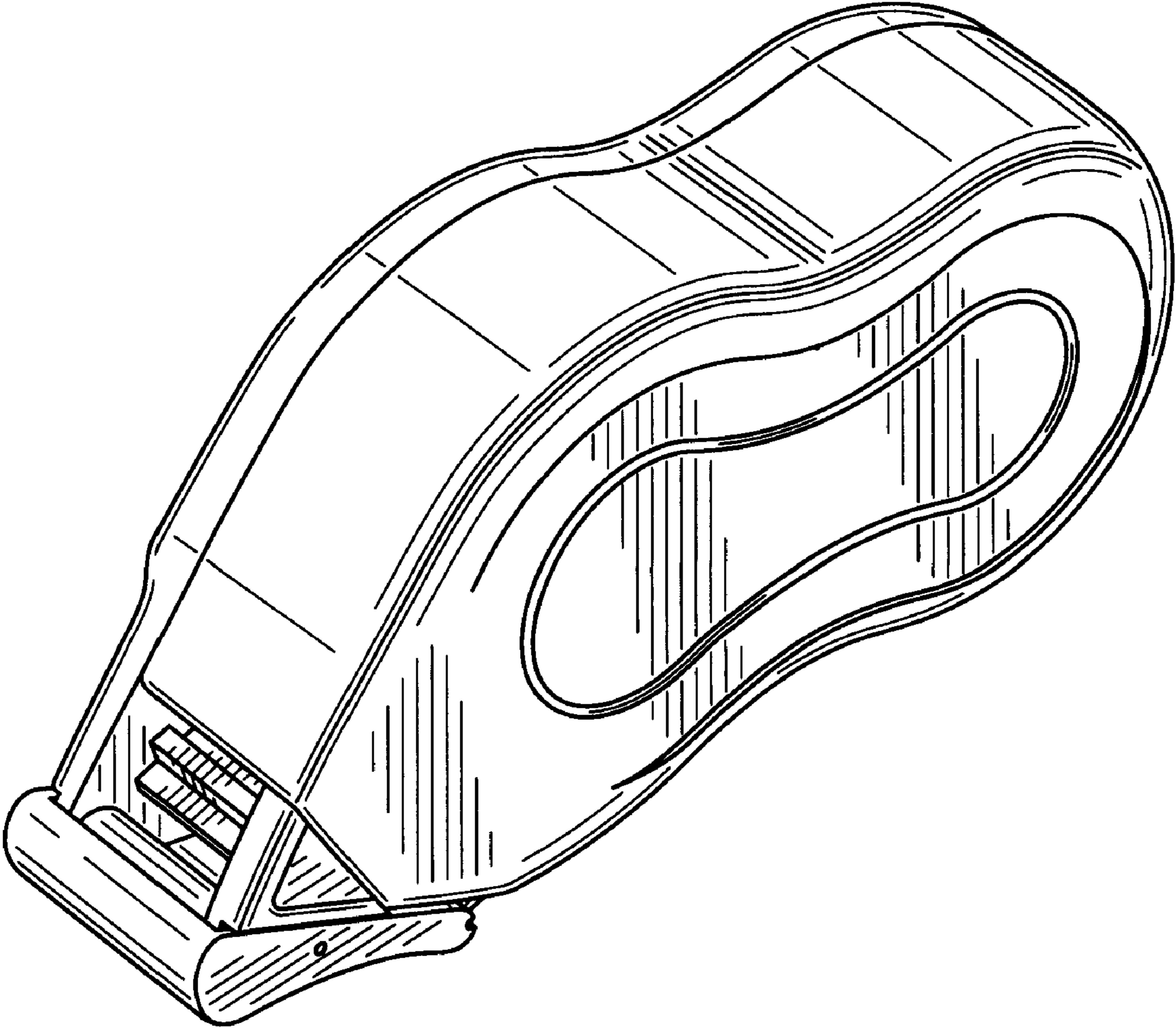

FIG. 1

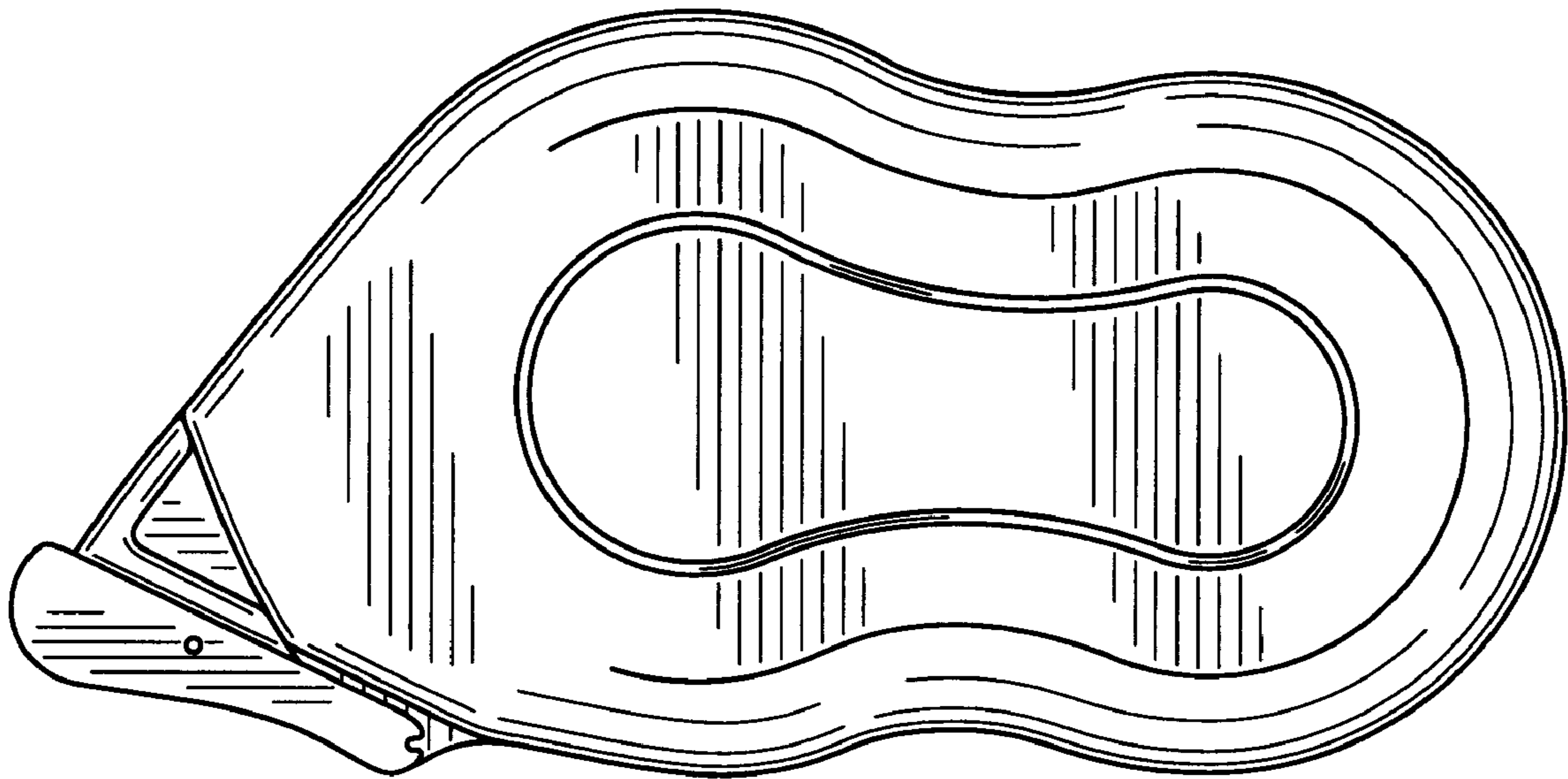

FIG. 2

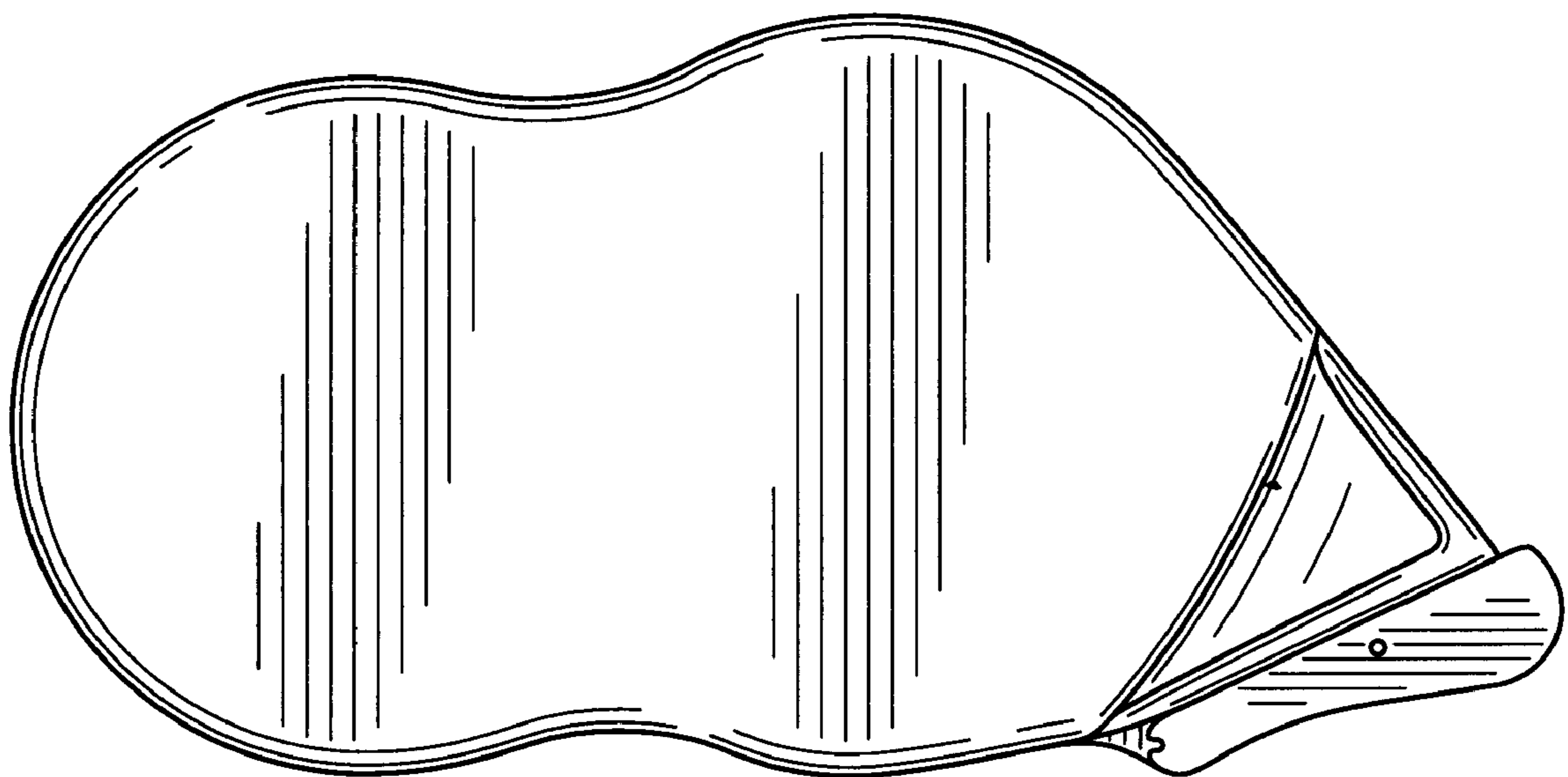

FIG. 3

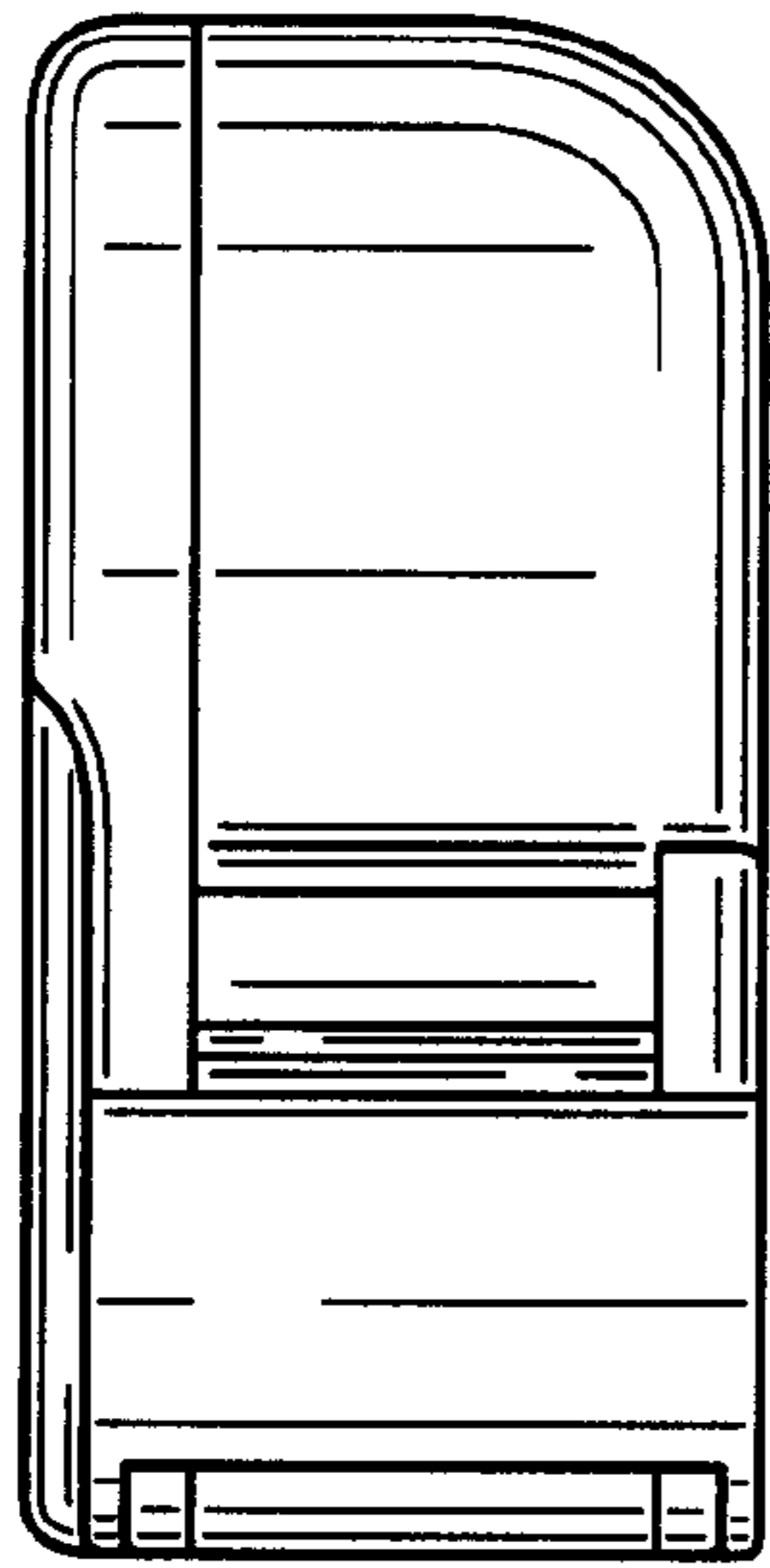

FIG. 4

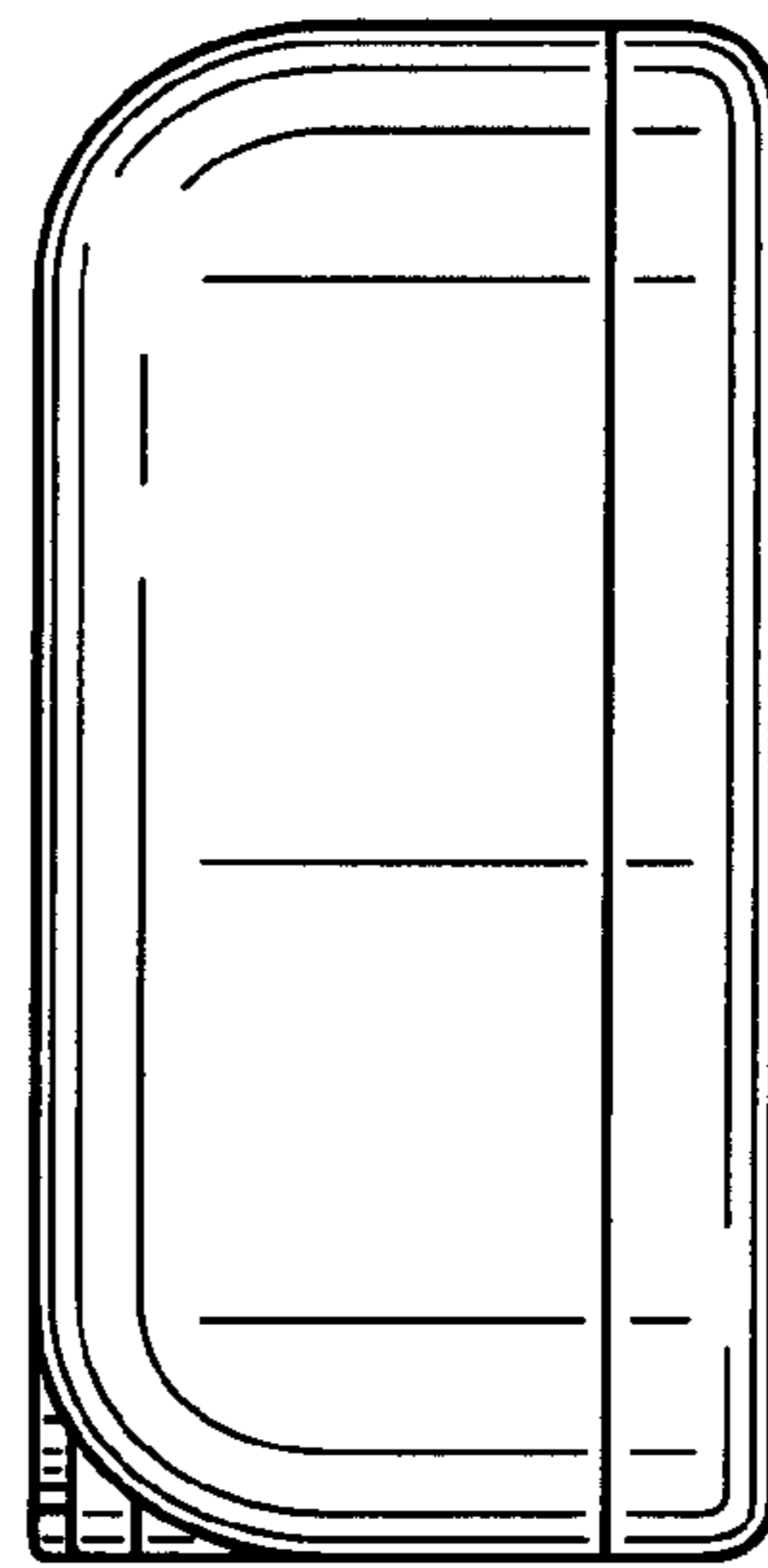

FIG. 5

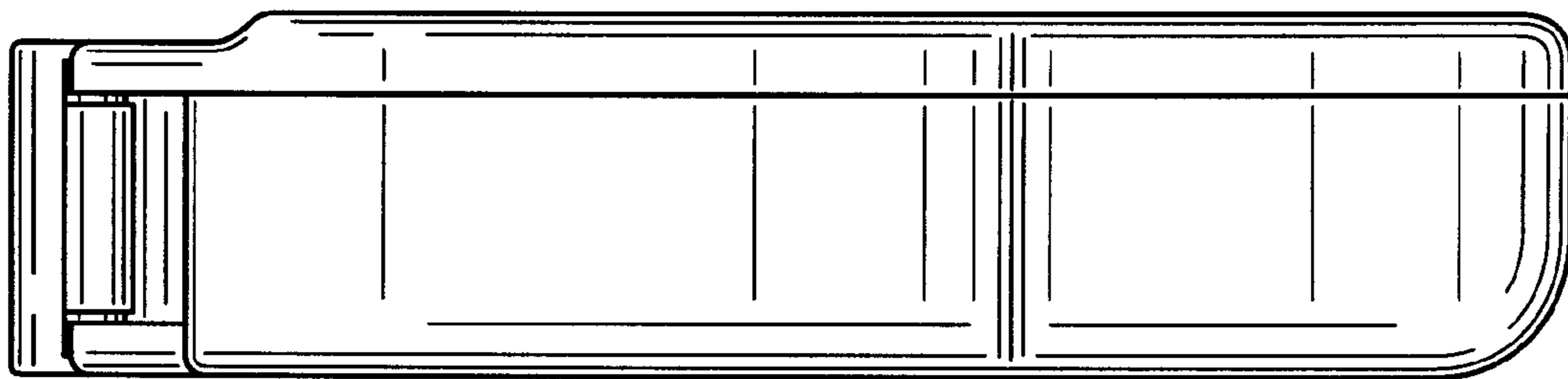

FIG. 6

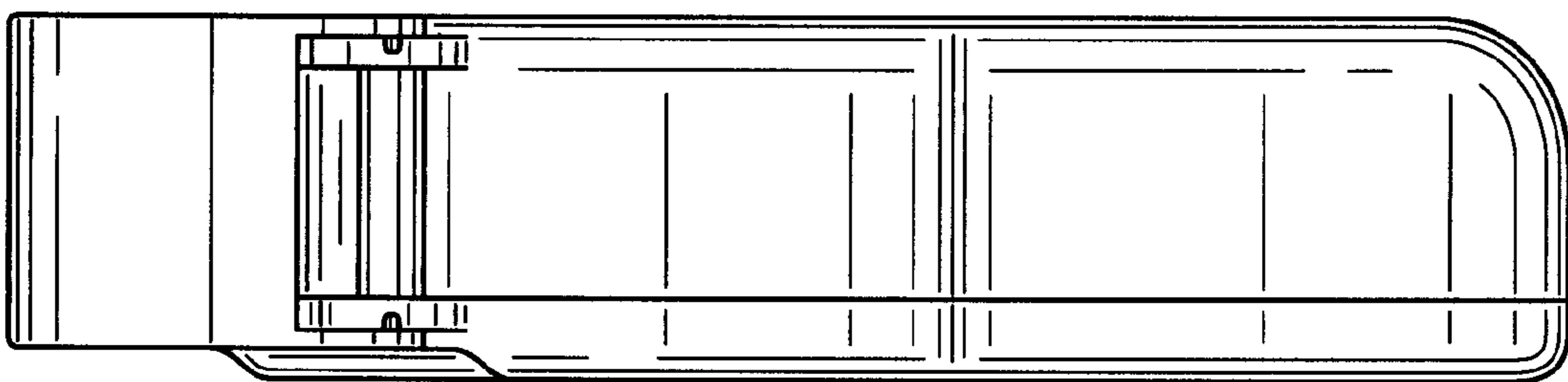

FIG. 7

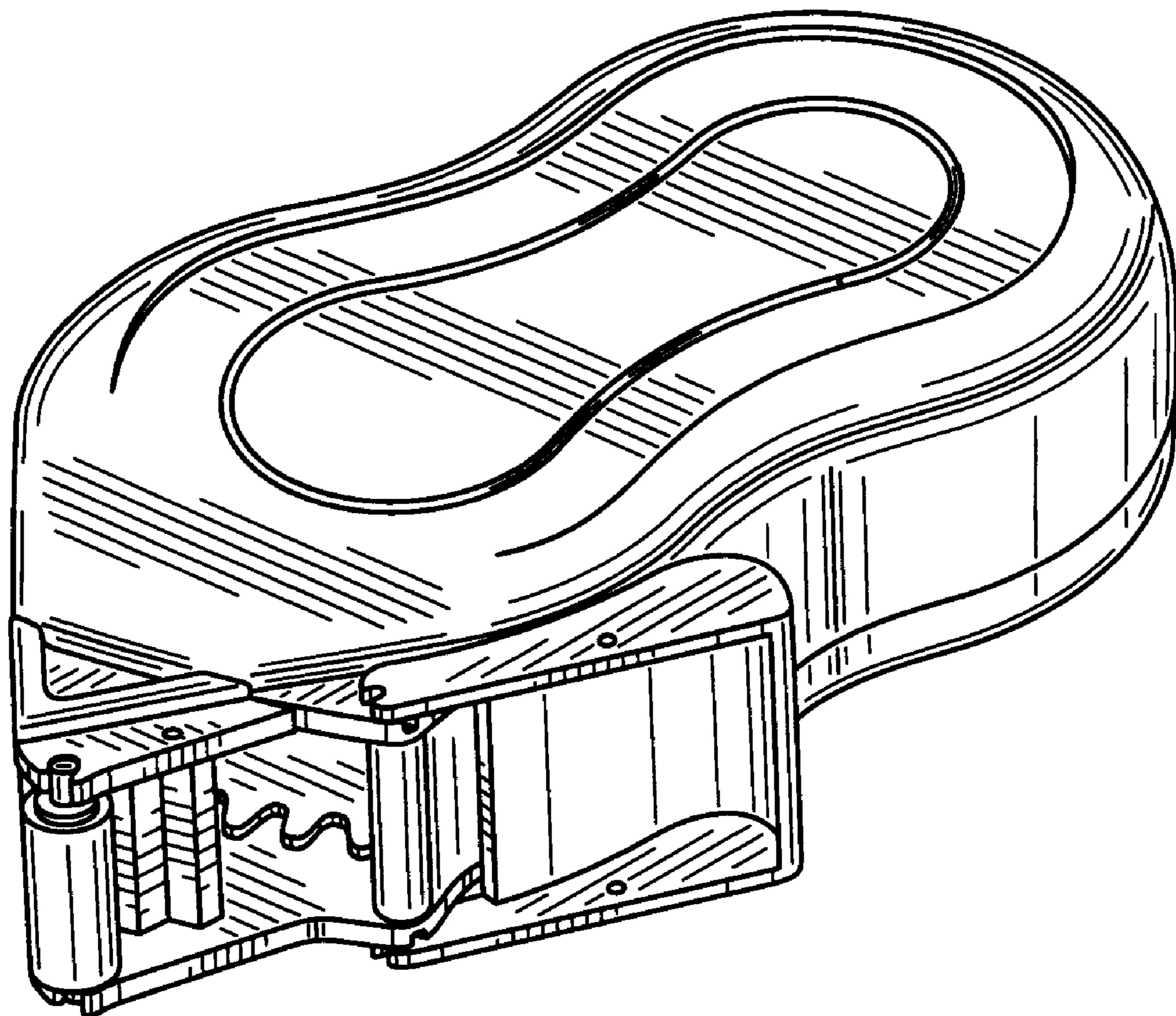

FIG. 8