



US00D550750S

(12) **United States Design Patent**
Chiang

(10) **Patent No.:** **US D550,750 S**

(45) **Date of Patent:** **** Sep. 11, 2007**

(54) **SWIMMING GOGGLE**

(76) Inventor: **Herman Chiang**, 11F-2, No. 634-9,
Ching-Ping Rd., Chung-Ho City, Taipei
Hsien (TW)

(**) Term: **14 Years**

(21) Appl. No.: **29/257,355**

(22) Filed: **Apr. 4, 2006**

(51) **LOC (8) Cl.** **06-16**

(52) **U.S. Cl.** **D16/311**

(58) **Field of Classification Search** D16/101,
D16/300-330, 332-338, 900; D21/190;
D24/110.2; 351/41, 44, 51, 52, 61-63, 83,
351/86, 92, 103-111, 114, 117, 119, 121-124,
351/128, 130-132, 136-139, 153, 158; 2/426-432,
2/434-437, 439, 440, 441, 445, 447-449,
2/453, 444

See application file for complete search history.

(56) **References Cited**

U.S. PATENT DOCUMENTS

D343,029 S *	1/1994	Berenson	D16/311
D385,574 S *	10/1997	Fireman	D16/311
D434,061 S *	11/2000	Chiang	D16/311
6,405,384 B1 *	6/2002	Chiang	2/428
D460,979 S *	7/2002	Chiang	D16/311
D471,224 S *	3/2003	Chiang	D16/303

D499,440 S *	12/2004	Chiang	D16/311
7,020,905 B2 *	4/2006	Chiang	2/448
2005/0132478 A1 *	6/2005	Canavan	2/448
2005/0155139 A1 *	7/2005	Chiang	2/428
2005/0264753 A1 *	12/2005	Hartley et al.	351/83
2006/0218705 A1 *	10/2006	Chiang	2/448
2006/0242753 A1 *	11/2006	Shiue	2/447

* cited by examiner

Primary Examiner—T. Chase Nelson

Assistant Examiner—Barbara Blanton Lohr

(74) *Attorney, Agent, or Firm*—Rosenberg, Klein & Lee

(57) **CLAIM**

The ornamental design for a swimming goggle, as shown and described.

DESCRIPTION

FIG. 1 is a perspective view of a swimming goggle showing my new design;

FIG. 2 is a front elevational view thereof;

FIG. 3 is a rear elevational view thereof;

FIG. 4 is a left elevational view thereof;

FIG. 5 is a right elevational view thereof;

FIG. 6 is a top plan view thereof; and,

FIG. 7 is a bottom plan view thereof.

1 Claim, 4 Drawing Sheets

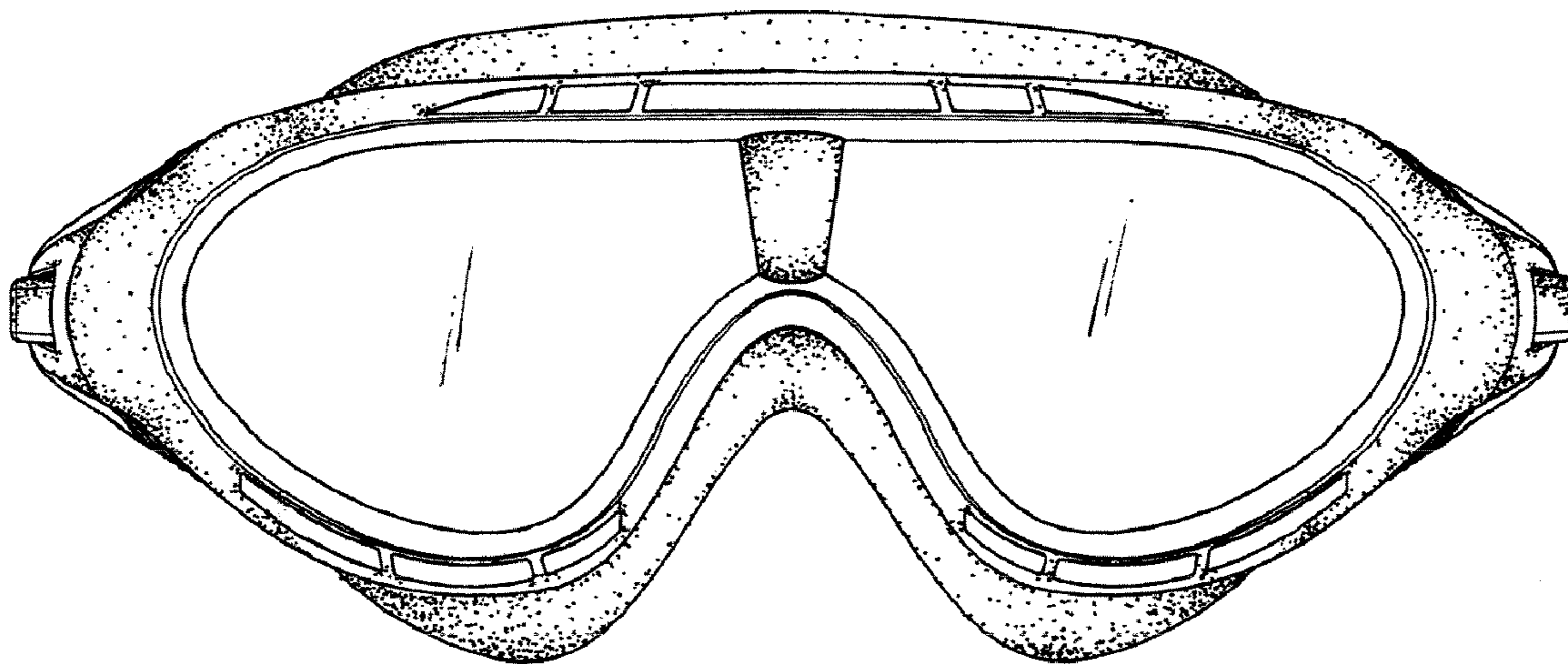

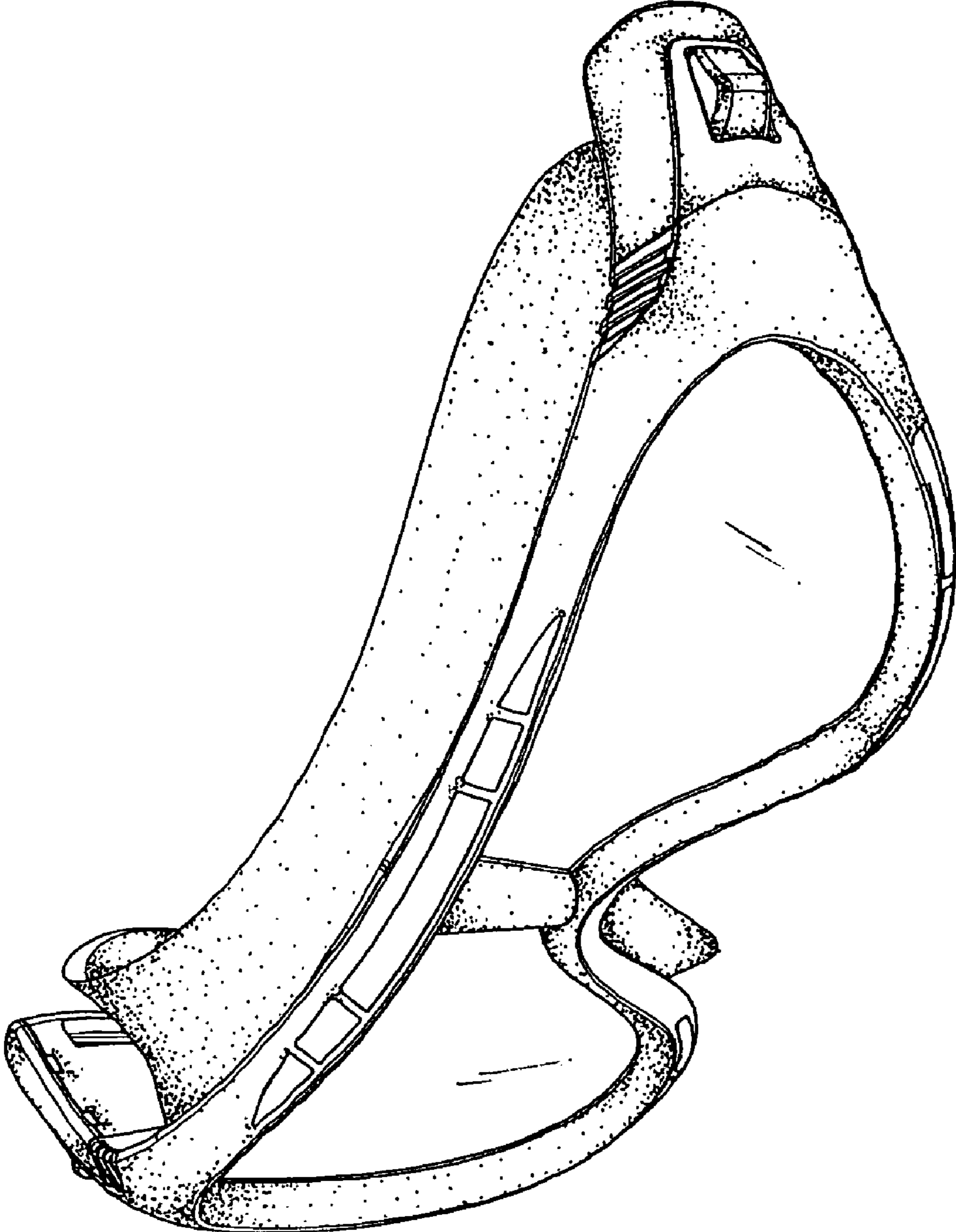

FIG. 1

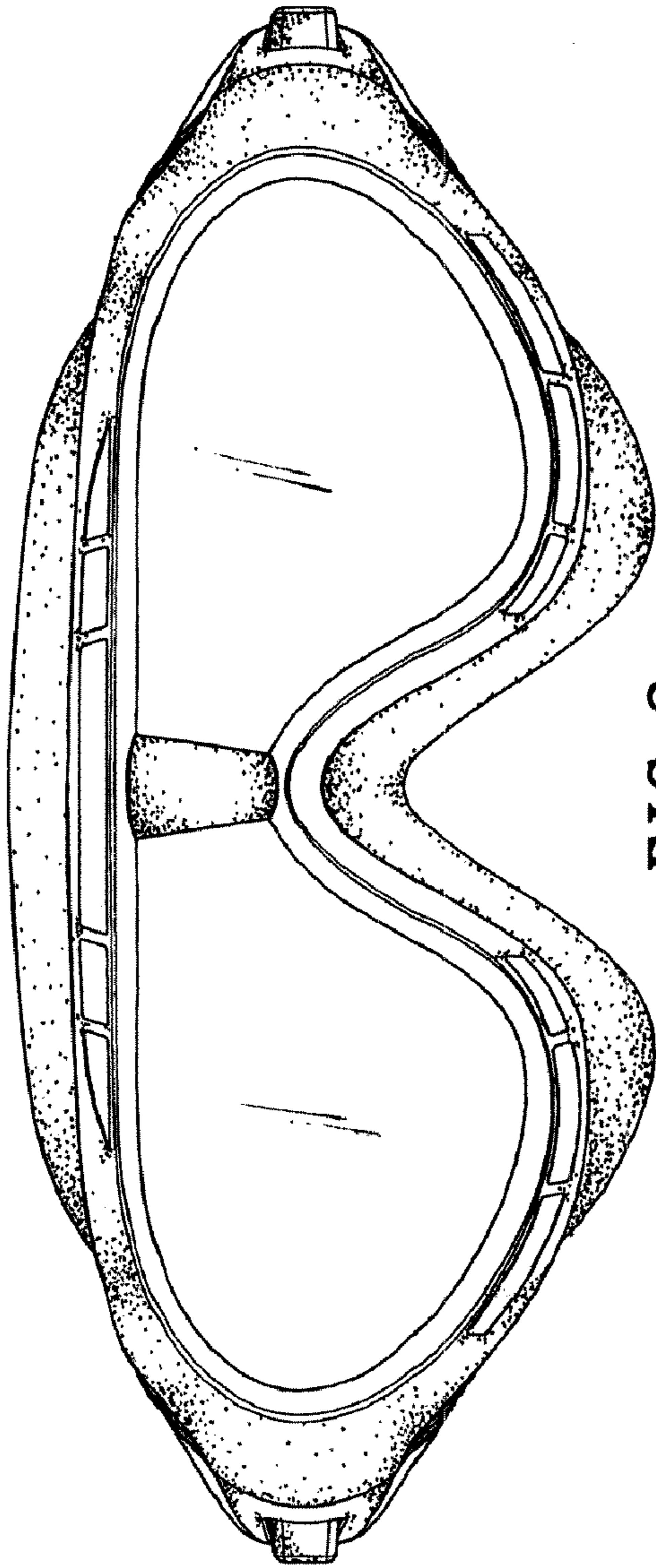

FIG. 2

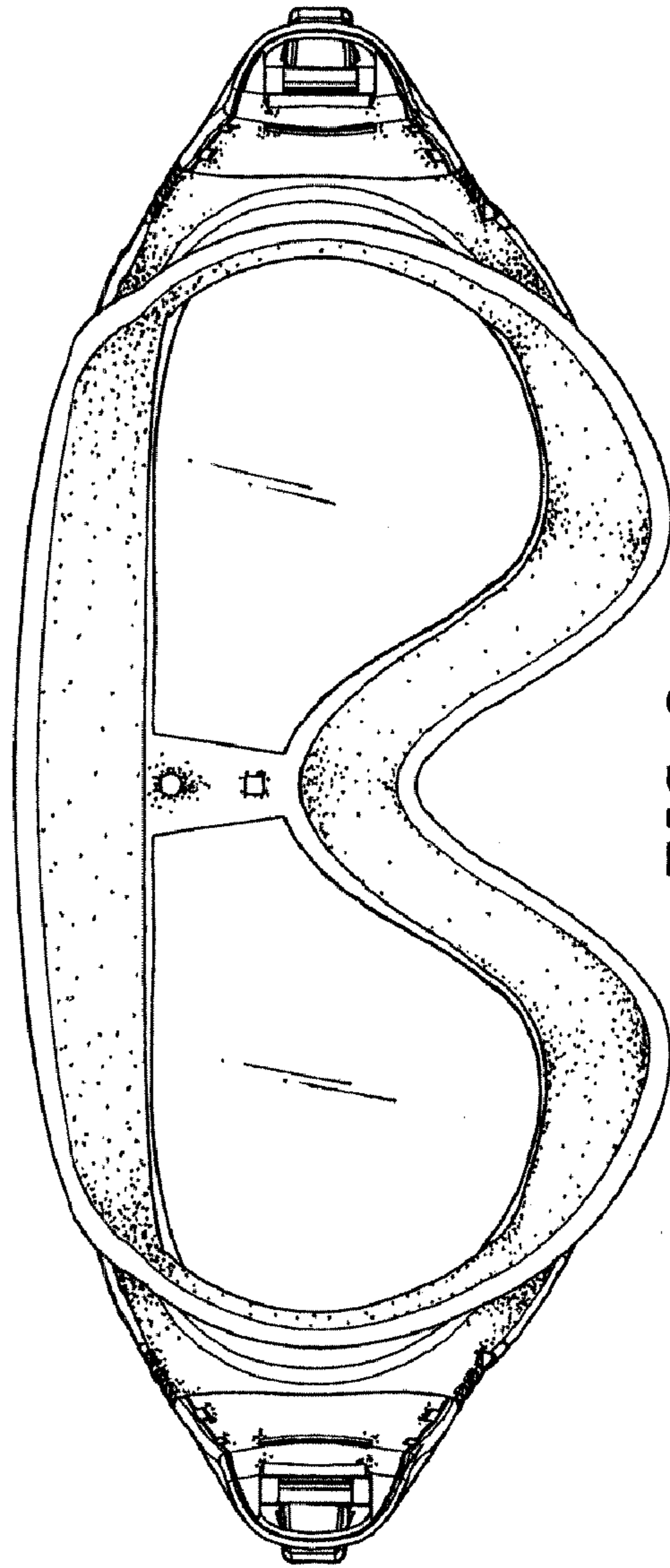

FIG. 3

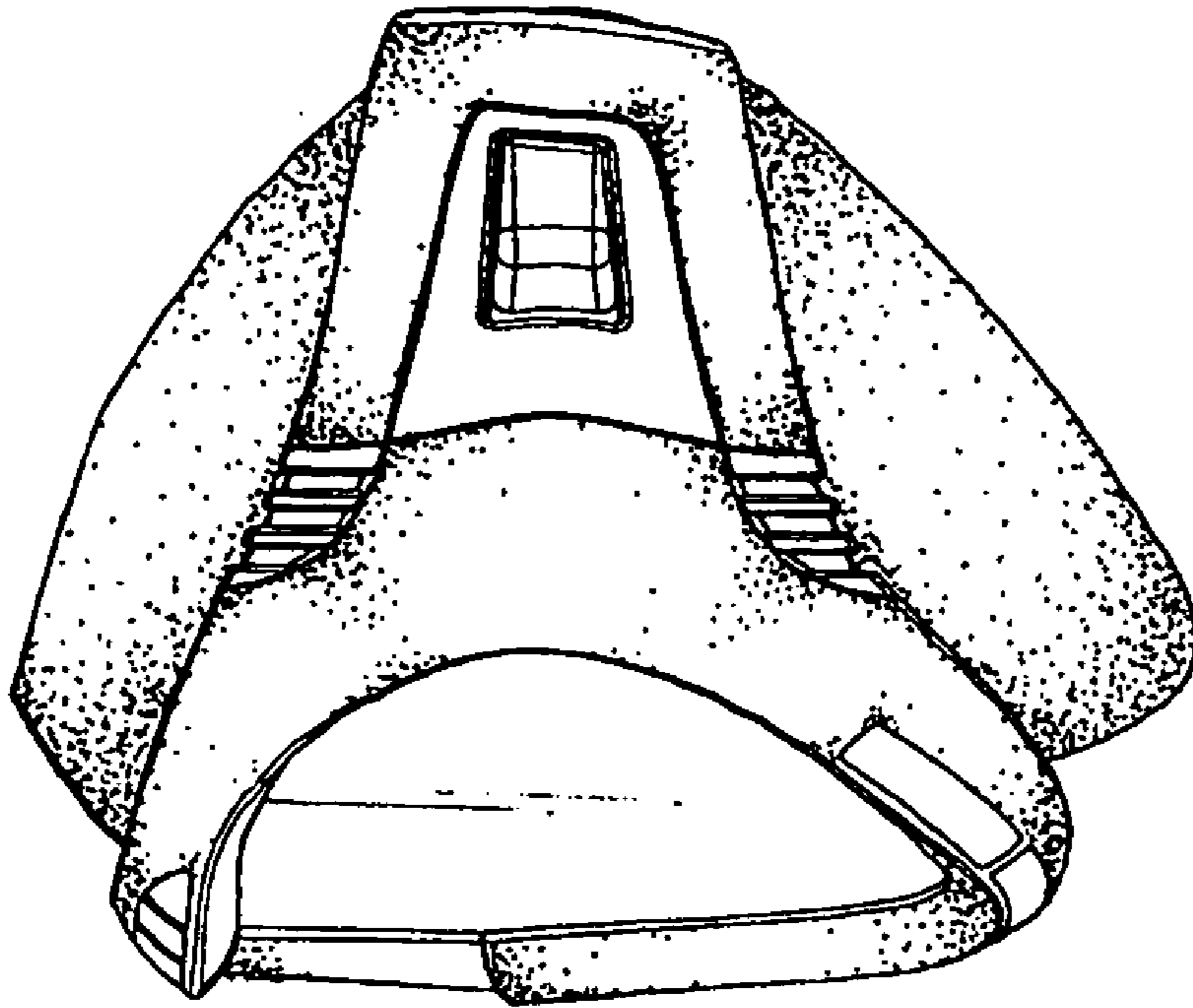

FIG. 5

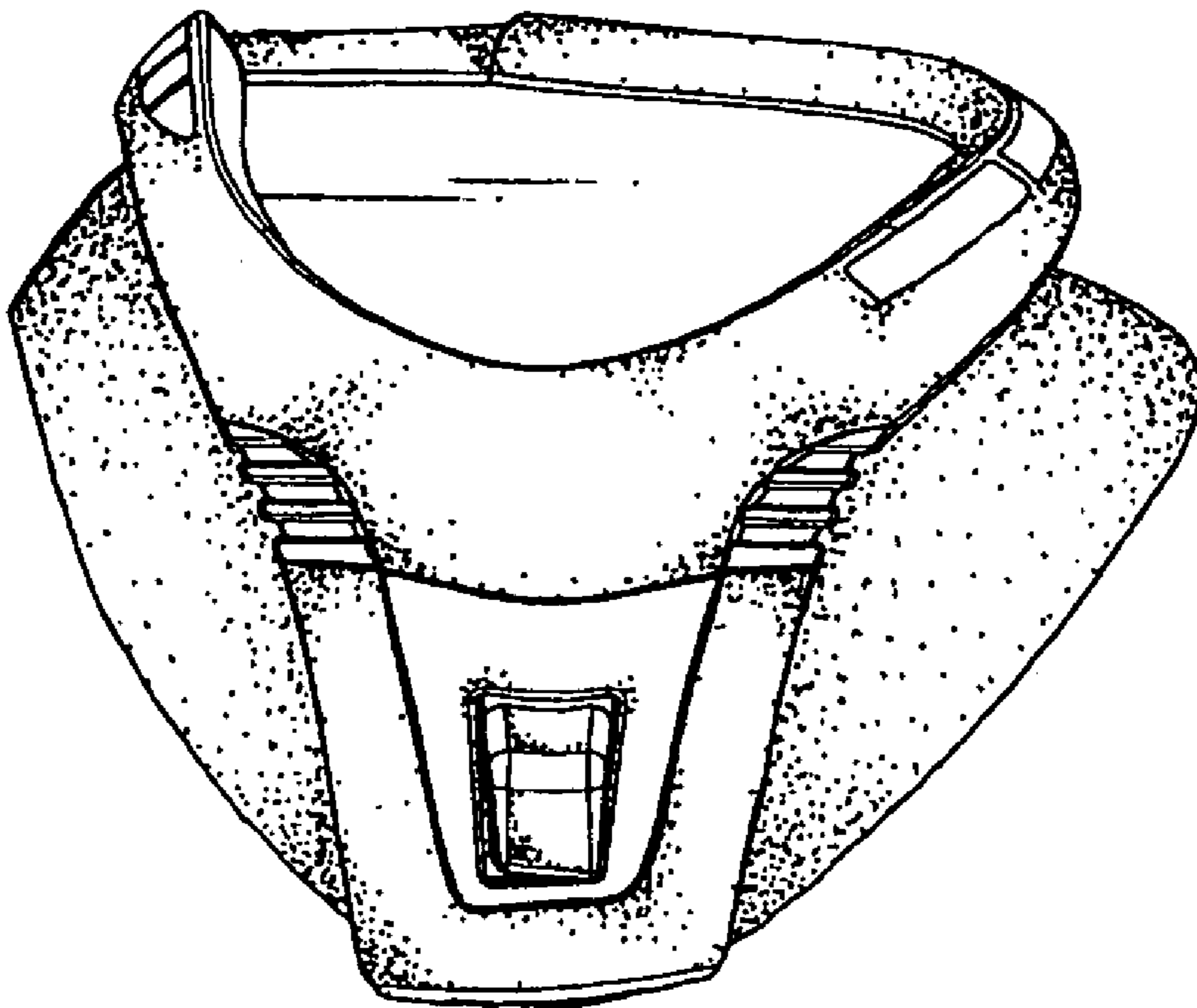

FIG. 4

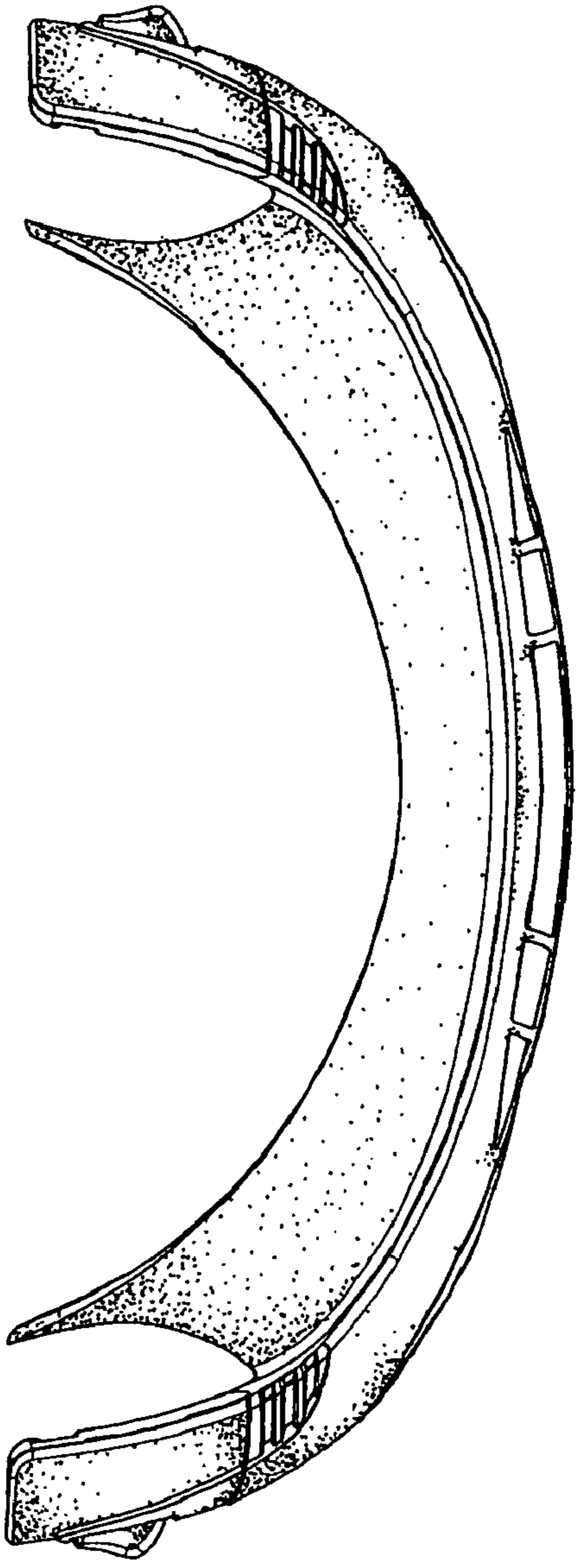

FIG. 6

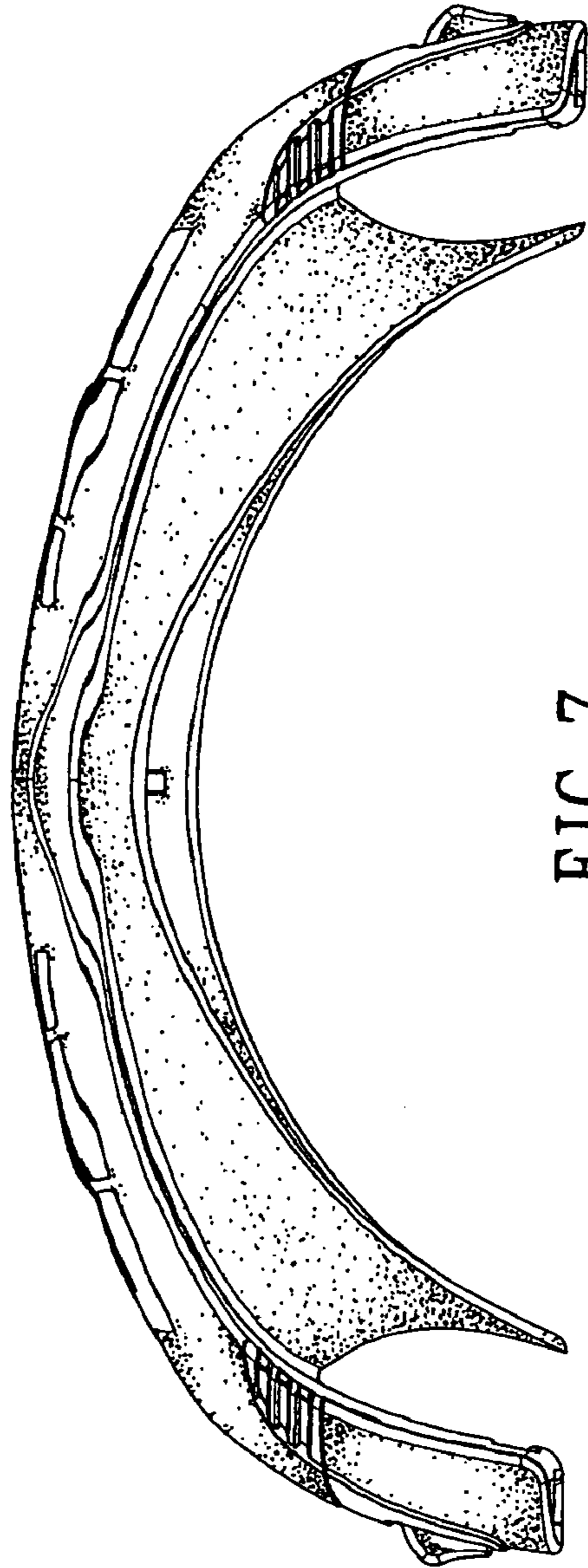

FIG. 7