



US00D550516S

(12) **United States Design Patent**  
**Tsai**

(10) **Patent No.:** **US D550,516 S**

(45) **Date of Patent:** **\*\* Sep. 11, 2007**

(54) **FRESH FOOD STORAGE CONTAINER**

D507,154 S \* 7/2005 Kim ..... D7/610

(76) Inventor: **Mei-Hua Tsai**, 4F., No. 14, Lane 379,  
ChungMei Street, Taichung City (TW)

\* cited by examiner

*Primary Examiner*—Terry A. Wallace  
(74) *Attorney, Agent, or Firm*—Rabin & Berdo, P.C.

(\*\*) Term: **14 Years**

(21) Appl. No.: **29/263,496**

(57) **CLAIM**

(22) Filed: **Jul. 25, 2006**

The ornamental design for a fresh food storage container, as shown and described.

(51) **LOC (8) Cl.** ..... **07-07**

(52) **U.S. Cl.** ..... **D7/629**

(58) **Field of Classification Search** ..... D7/601,  
D7/602, 629, 630, 709, 612–615, 538–542;  
220/780–806; D9/414, 424–432; 206/213,  
206/541

See application file for complete search history.

**DESCRIPTION**

FIG. 1 is a perspective view of a fresh food storage container showing my new design;

FIG. 2 is a front view thereof;

FIG. 3 is a rear view thereof;

FIG. 4 is a left side view thereof;

FIG. 5 is a right side view thereof;

FIG. 6 is a top view thereof; and,

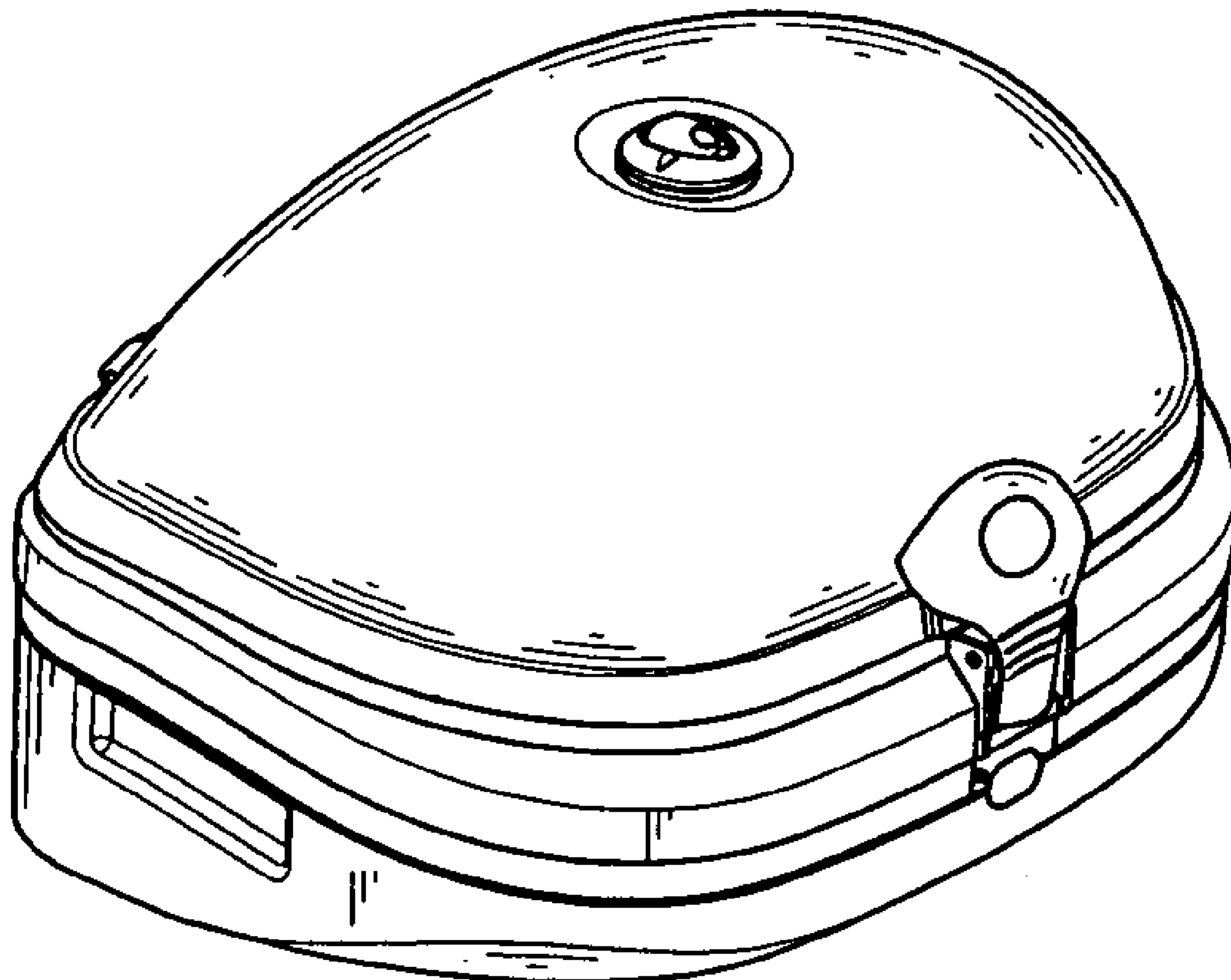
FIG. 7 is a bottom view thereof.

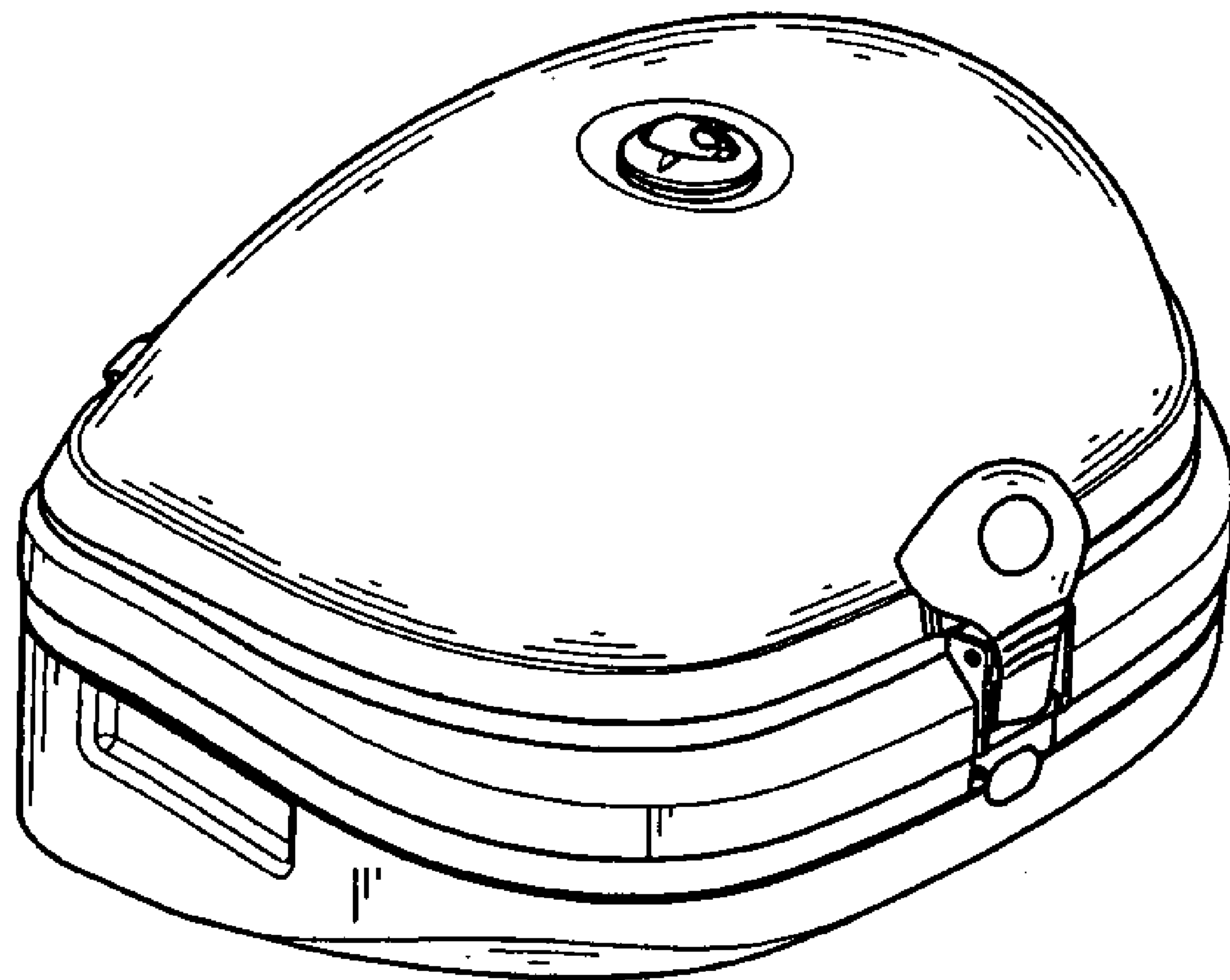
(56) **References Cited**

**U.S. PATENT DOCUMENTS**

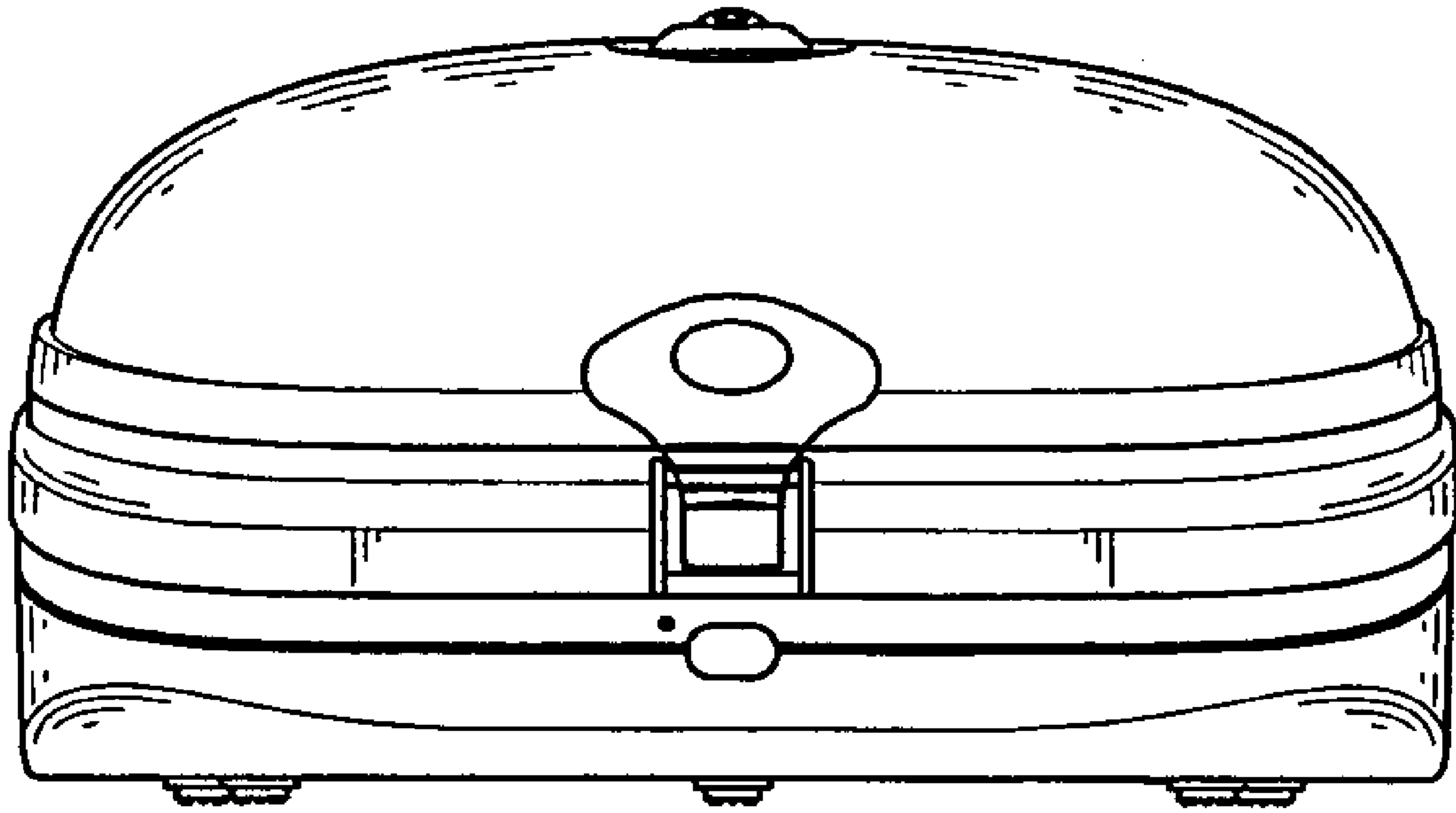
D322,031 S	*	12/1991	Fleming	.....	D9/424
D353,748 S	*	12/1994	Ferris et al.	.....	D7/709
D479,954 S	*	9/2003	Kim	.....	D7/629
D480,277 S	*	10/2003	Claypool	.....	D7/629

**1 Claim, 7 Drawing Sheets**

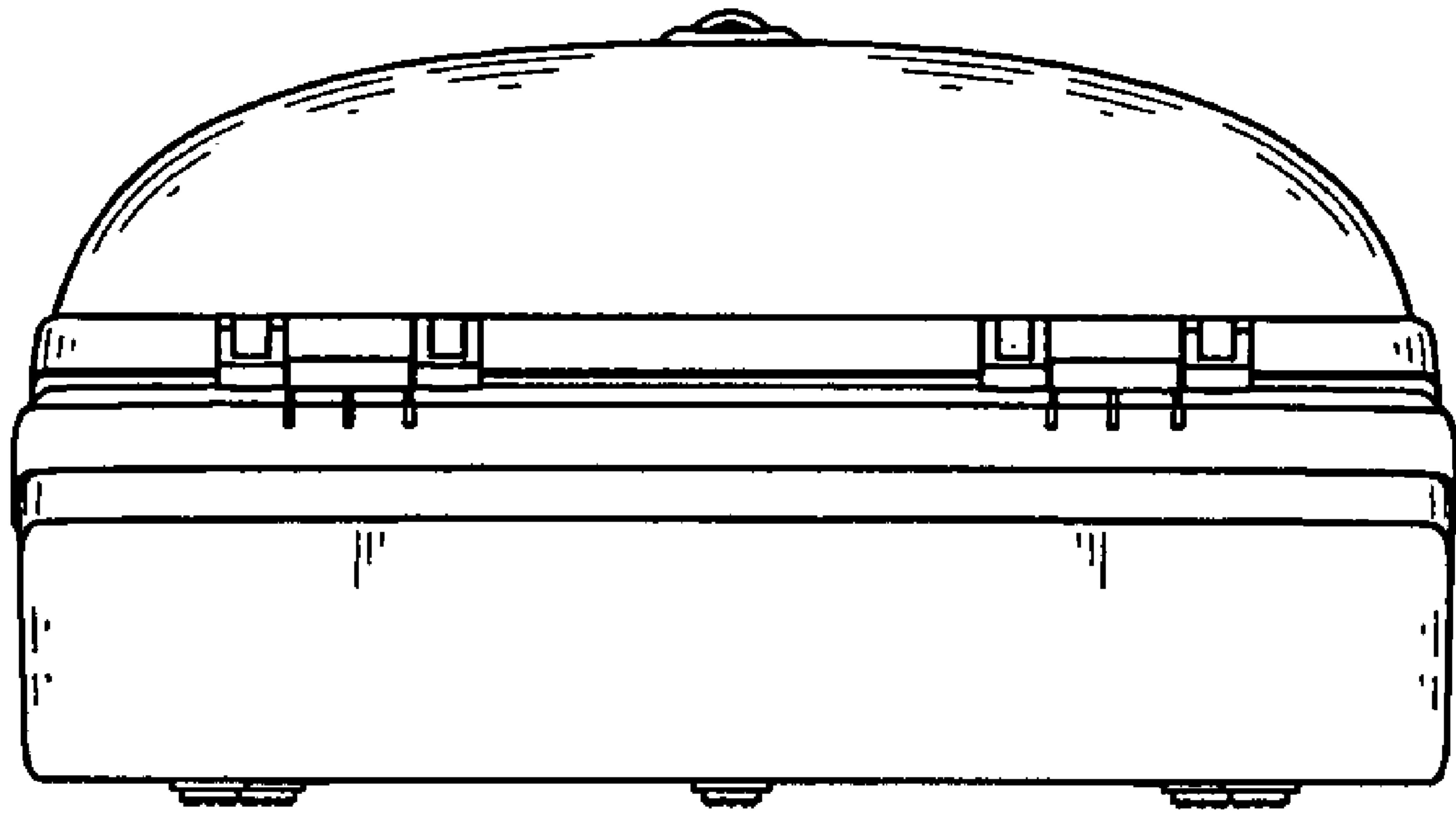




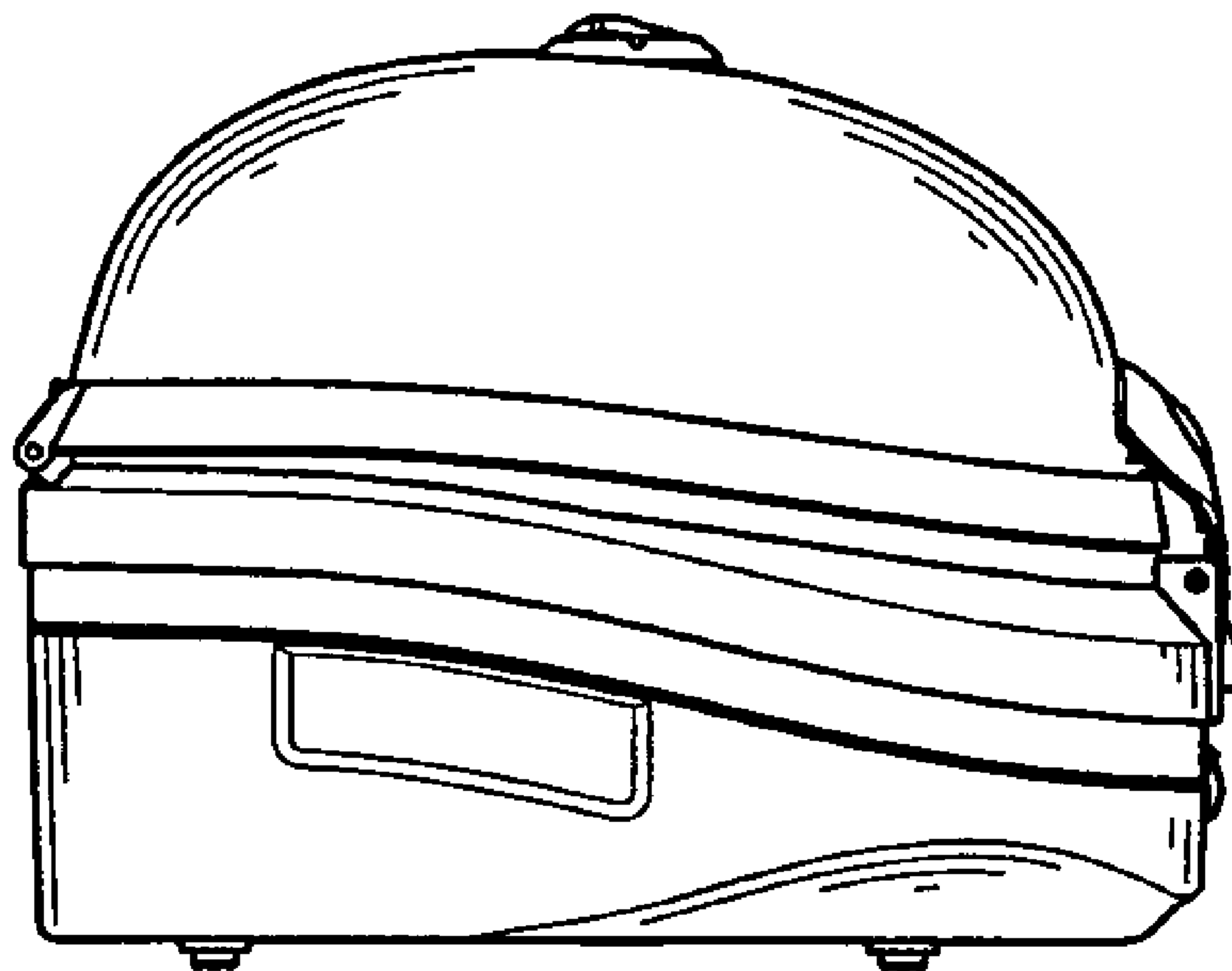
**FIG. 1**



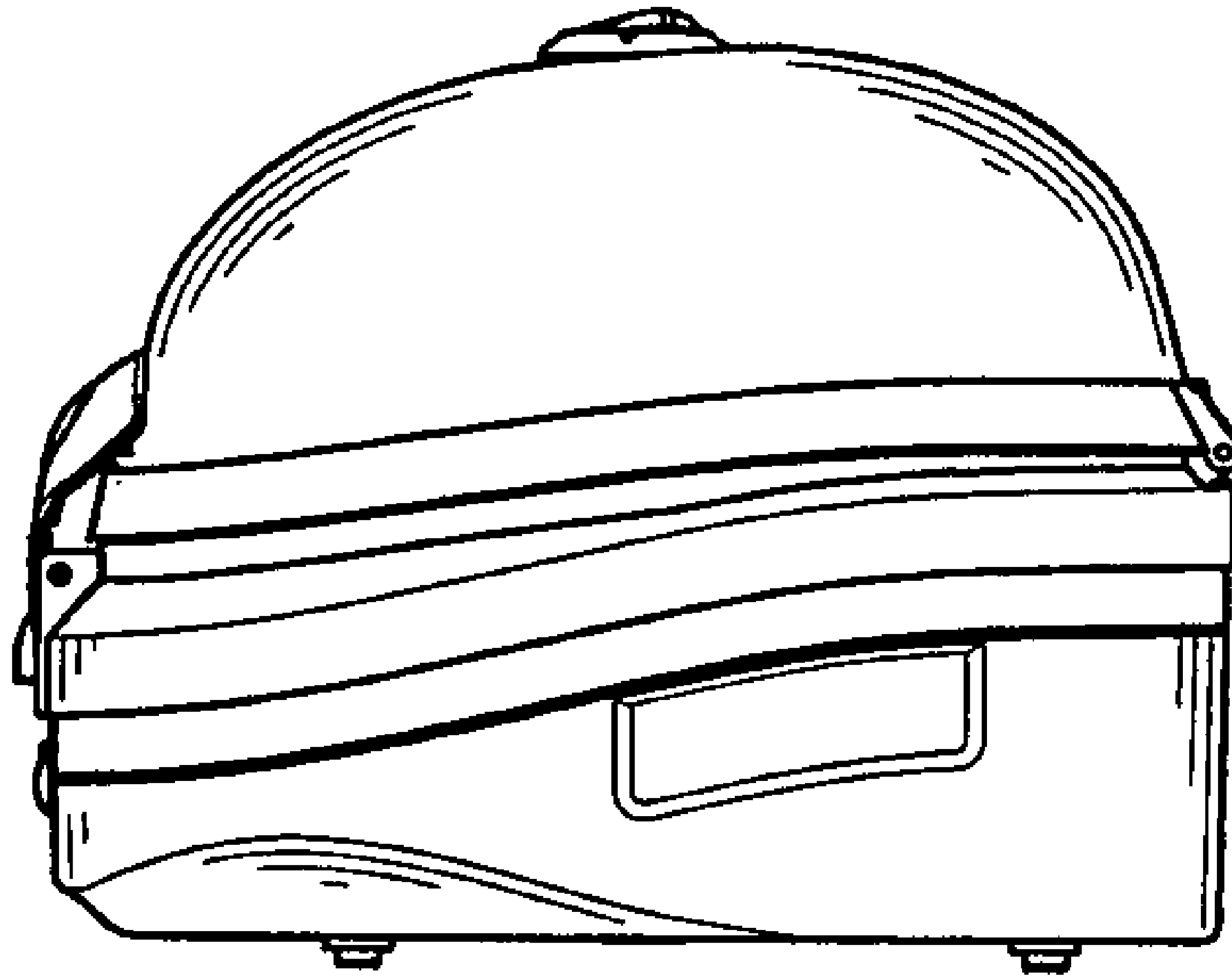
**FIG. 2**



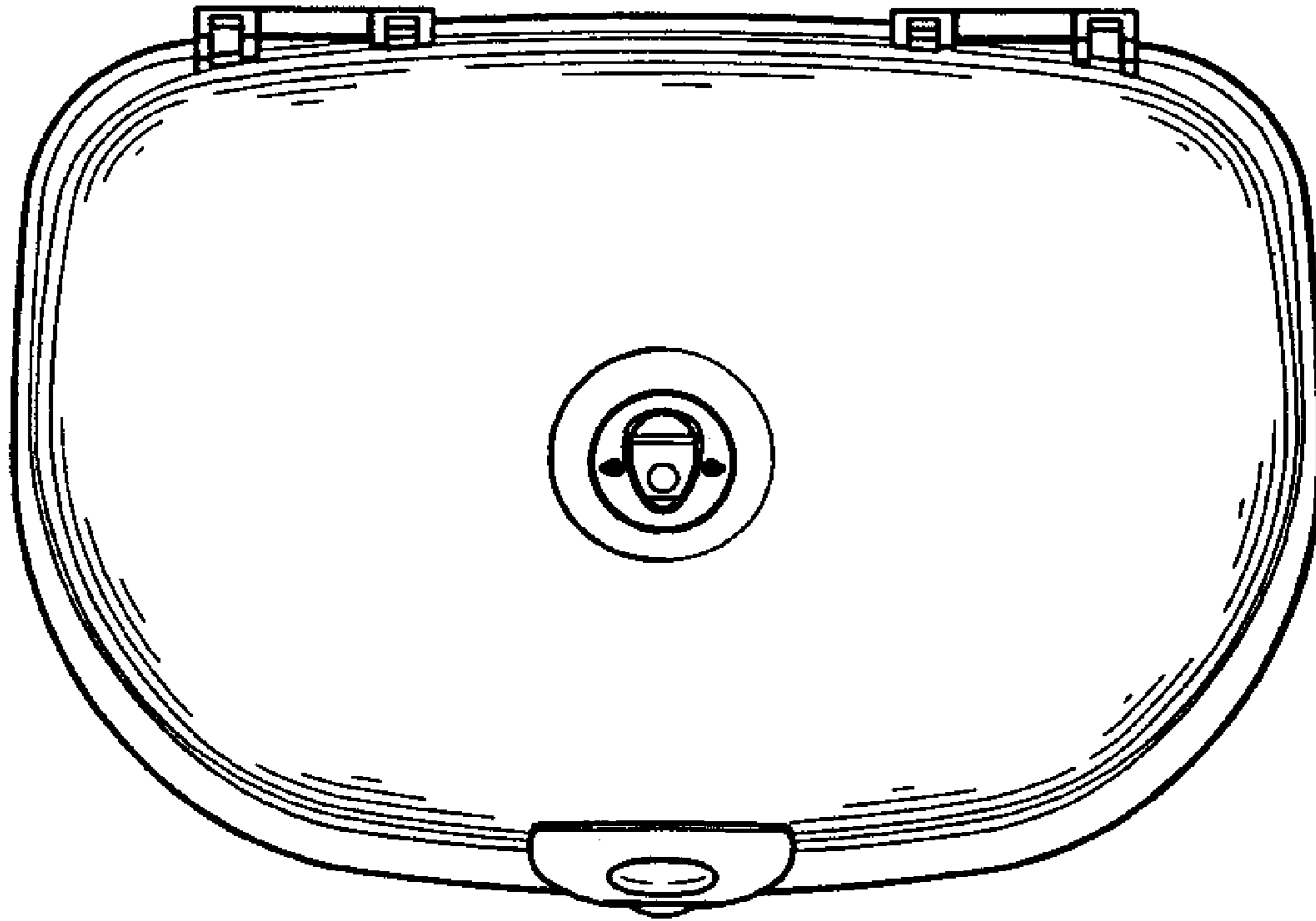
**FIG. 3**



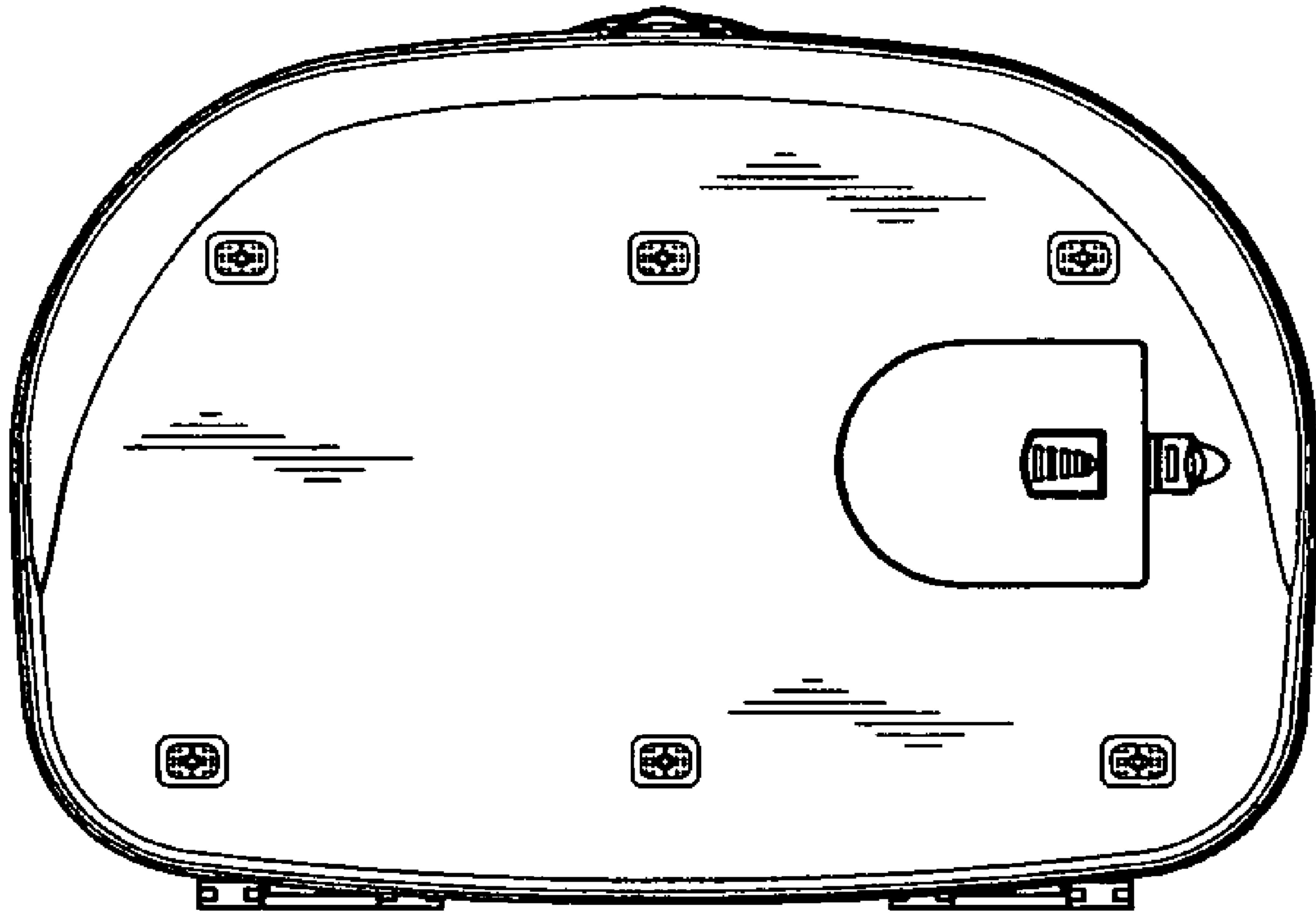
**FIG. 4**



**FIG. 5**



**FIG. 6**



**FIG. 7**