



US00D550458S

(12) **United States Design Patent**
Watson

(10) **Patent No.:** **US D550,458 S**

(45) **Date of Patent:** **** Sep. 11, 2007**

(54) **CAR TOY BOX**

(75) Inventor: **Patrick D. Watson**, Anthem, AZ (US)

(73) Assignee: **Shell Oil Company**, Houston, TX (US)

(**) Term: **14 Years**

(21) Appl. No.: **29/207,654**

(22) Filed: **Jun. 16, 2004**

(51) **LOC (8) Cl.** **03-01**

(52) **U.S. Cl.** **D3/304**

(58) **Field of Classification Search** D3/271.11,
D3/315, 310, 307, 303, 304, 308; D12/416;
D32/52; 220/560.9, 570

See application file for complete search history.

(56) **References Cited**

U.S. PATENT DOCUMENTS

D198,236 S *	5/1964	Schaefer	D3/308
D329,135 S *	9/1992	Embree	D3/308
D343,713 S *	1/1994	Barber	D3/308
D364,039 S *	11/1995	Kruger	D3/315
D376,477 S *	12/1996	Patterson, Jr.	D3/304
D385,111 S *	10/1997	Dickinson et al.	D3/309
D420,221 S *	2/2000	Williams et al.	D3/315
6,039,205 A *	3/2000	Flink	220/659
D492,113 S *	6/2004	Bayer et al.	D3/310

D497,309 S *	10/2004	Nordland et al.	D9/415
D519,913 S *	5/2006	Emerson	D12/407
D522,751 S *	6/2006	Irwin et al.	D3/315

* cited by examiner

Primary Examiner—Louis S. Zarfes

Assistant Examiner—Eric L. Goodman

(74) *Attorney, Agent, or Firm*—Kimbley L. Muller;
Margaret A. Boulware

(57) **CLAIM**

The ornamental design for the car toy box, as shown and described.

DESCRIPTION

FIG. 1 is a perspective view of a car toy box in accordance with my design;

FIG. 2 is a top plan view of the car toy box in accordance with my design;

FIG. 3 is a front elevation view of the car toy box in accordance with my design;

FIG. 4 is a rear elevation view of the car toy box in accordance with my design; and,

FIG. 5 is a bottom plan view of the car toy box in accordance with my design.

1 Claim, 2 Drawing Sheets

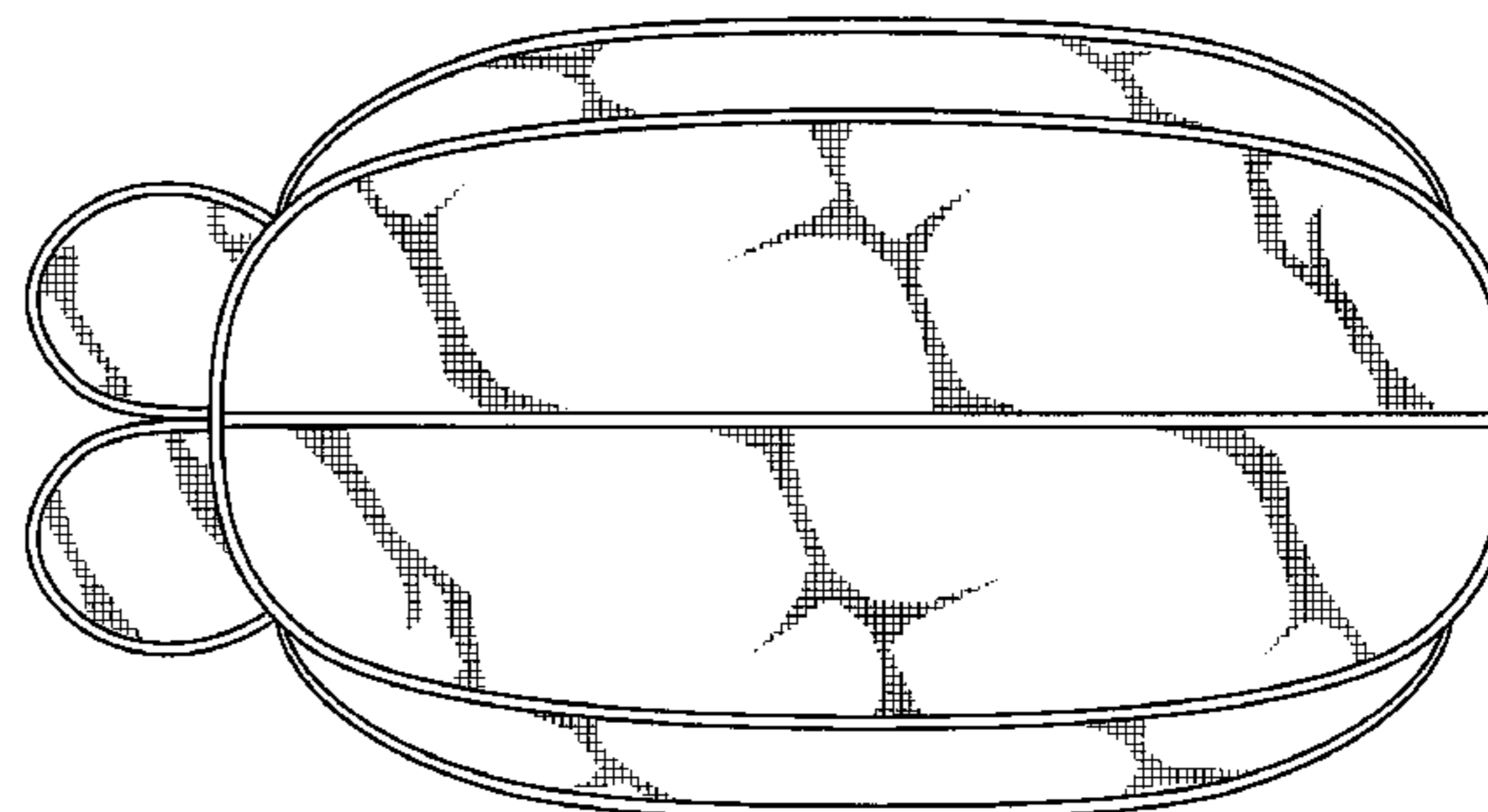
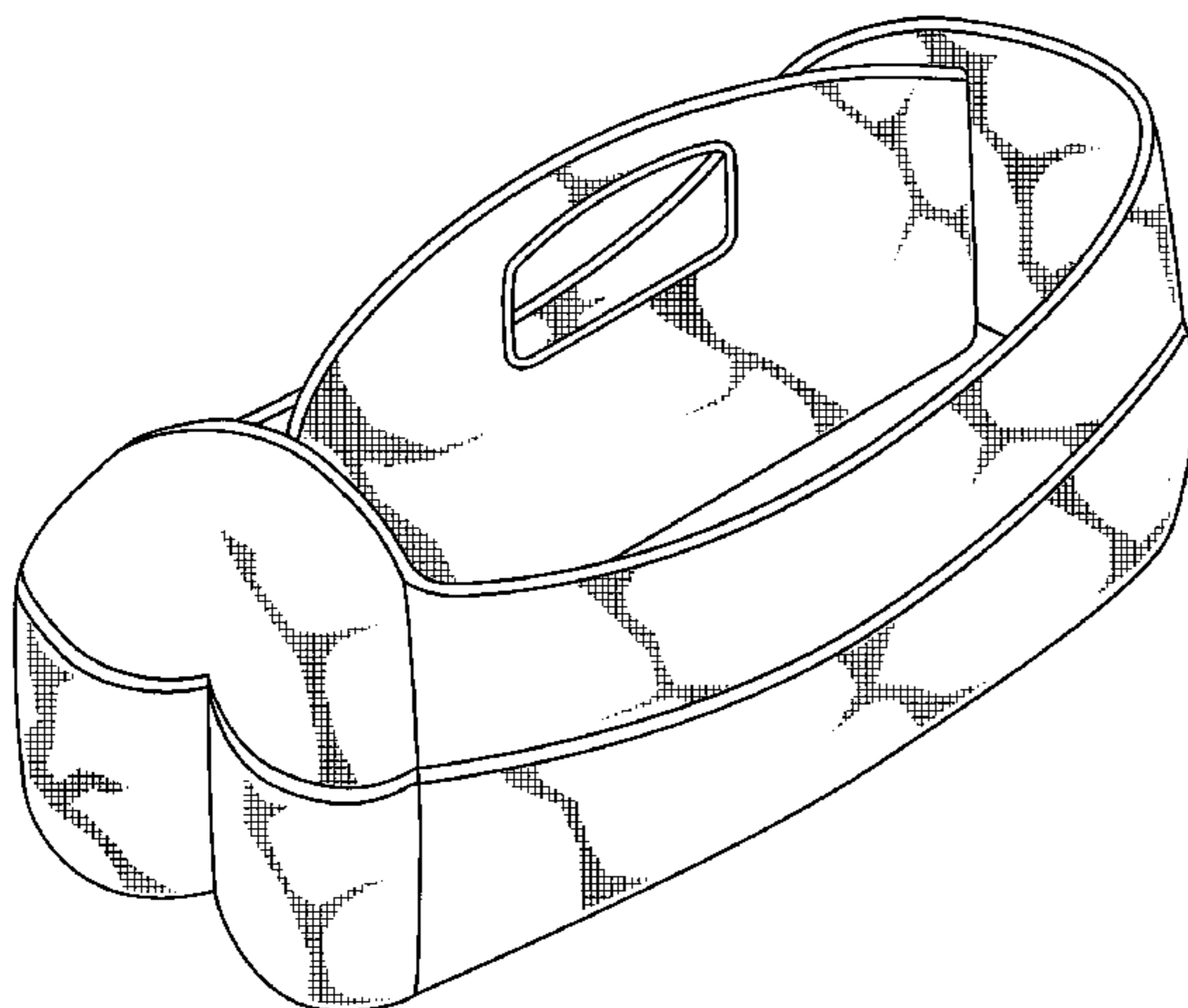

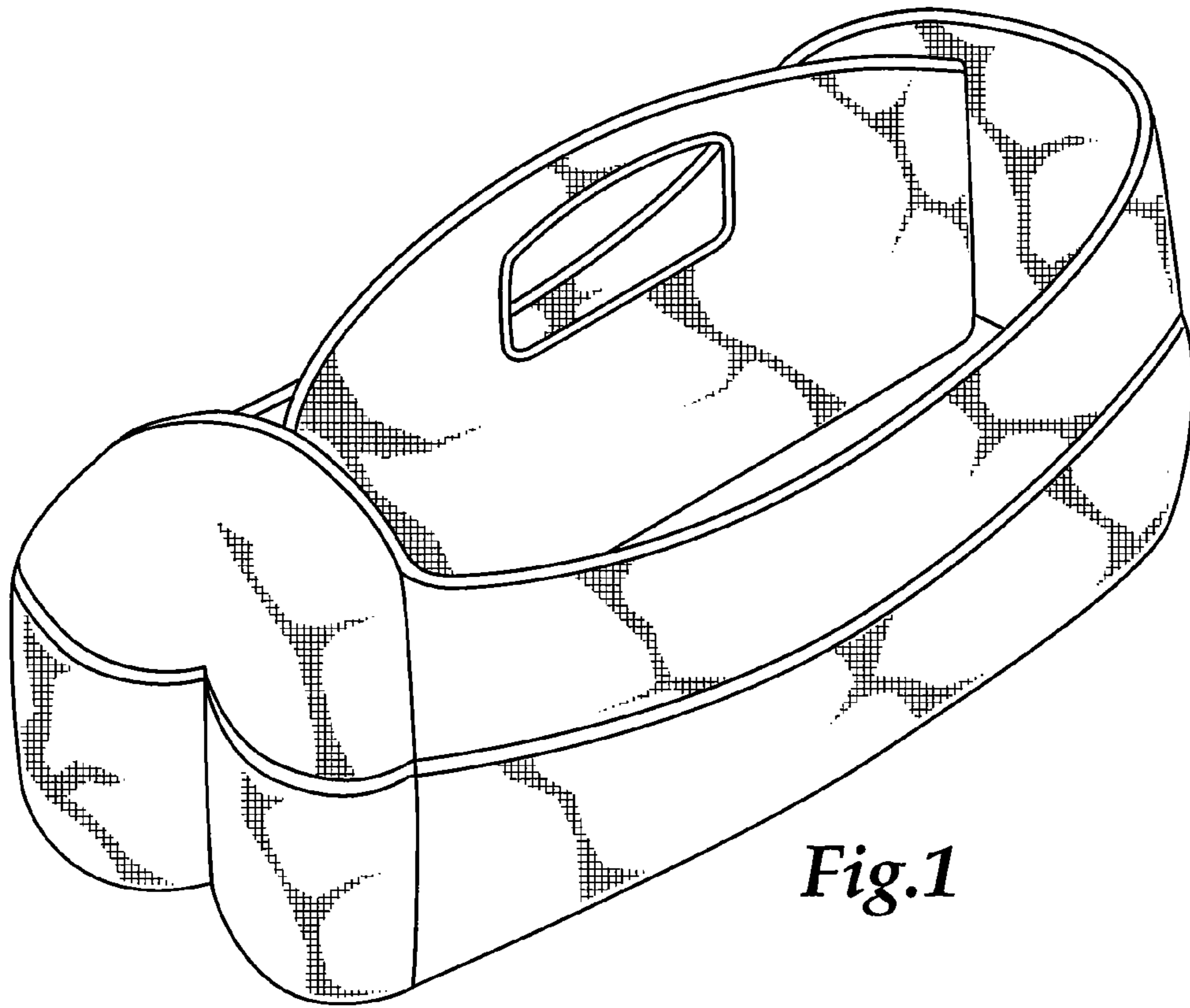

Fig.1

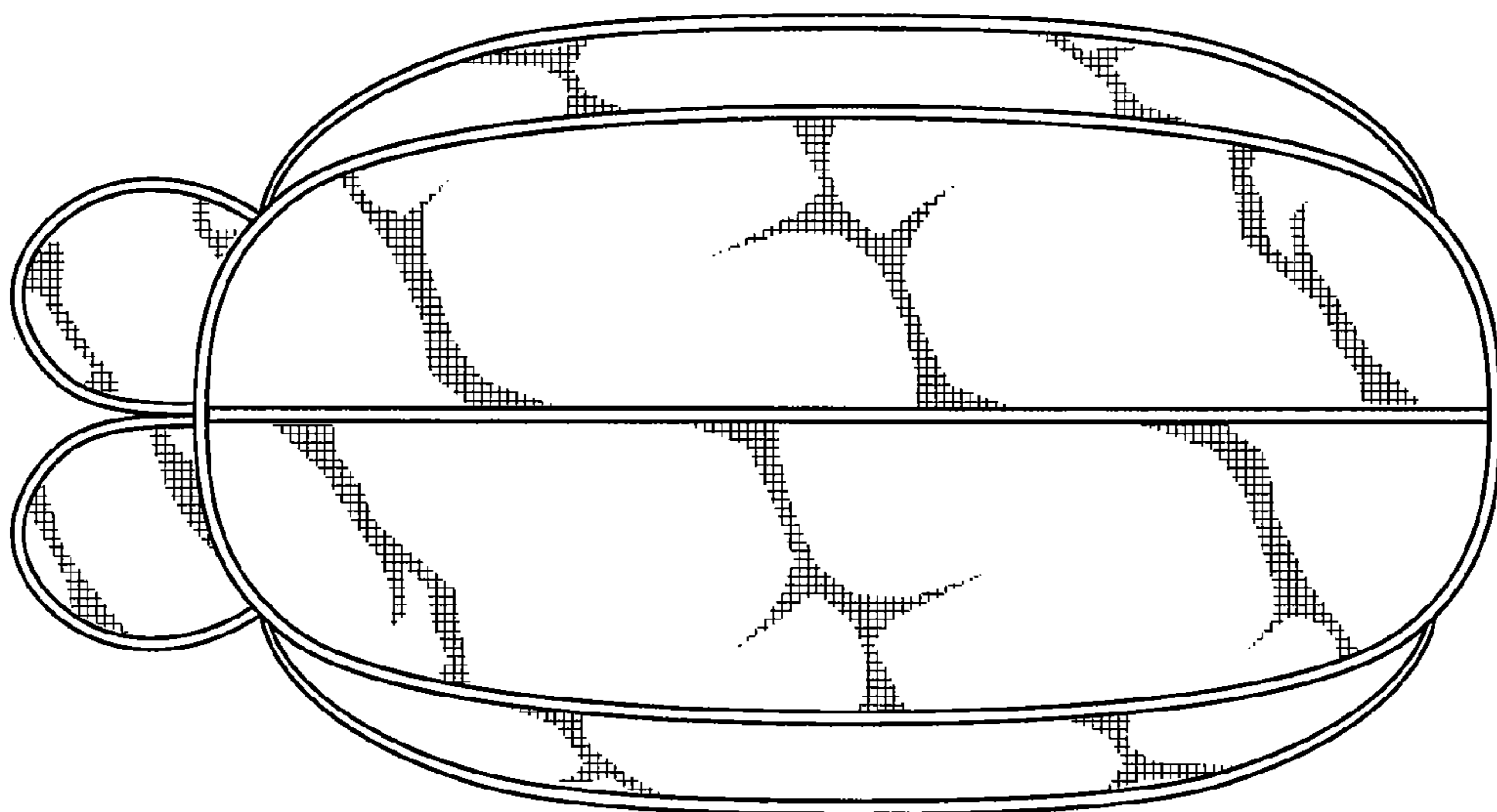

Fig.2

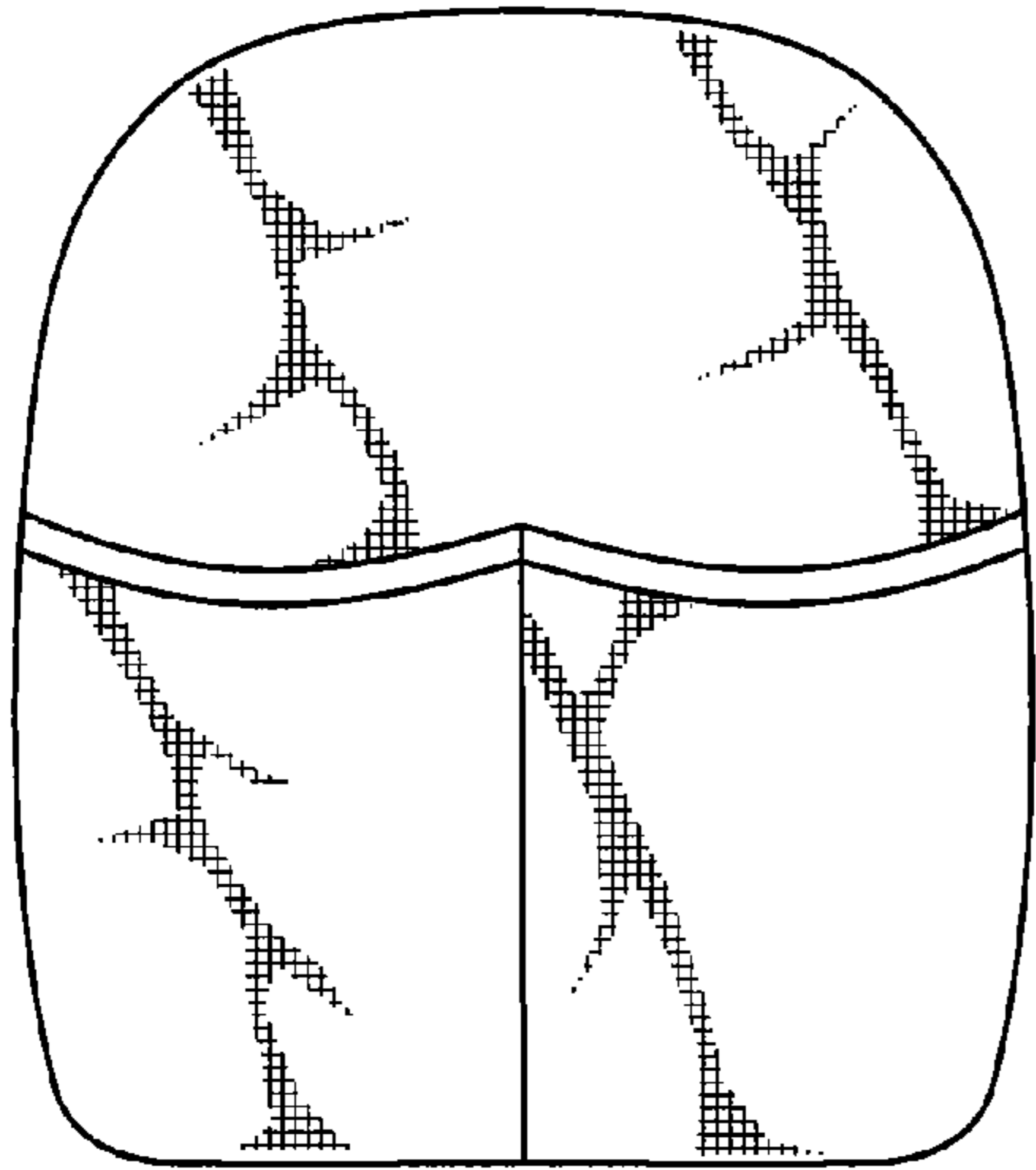

Fig.3

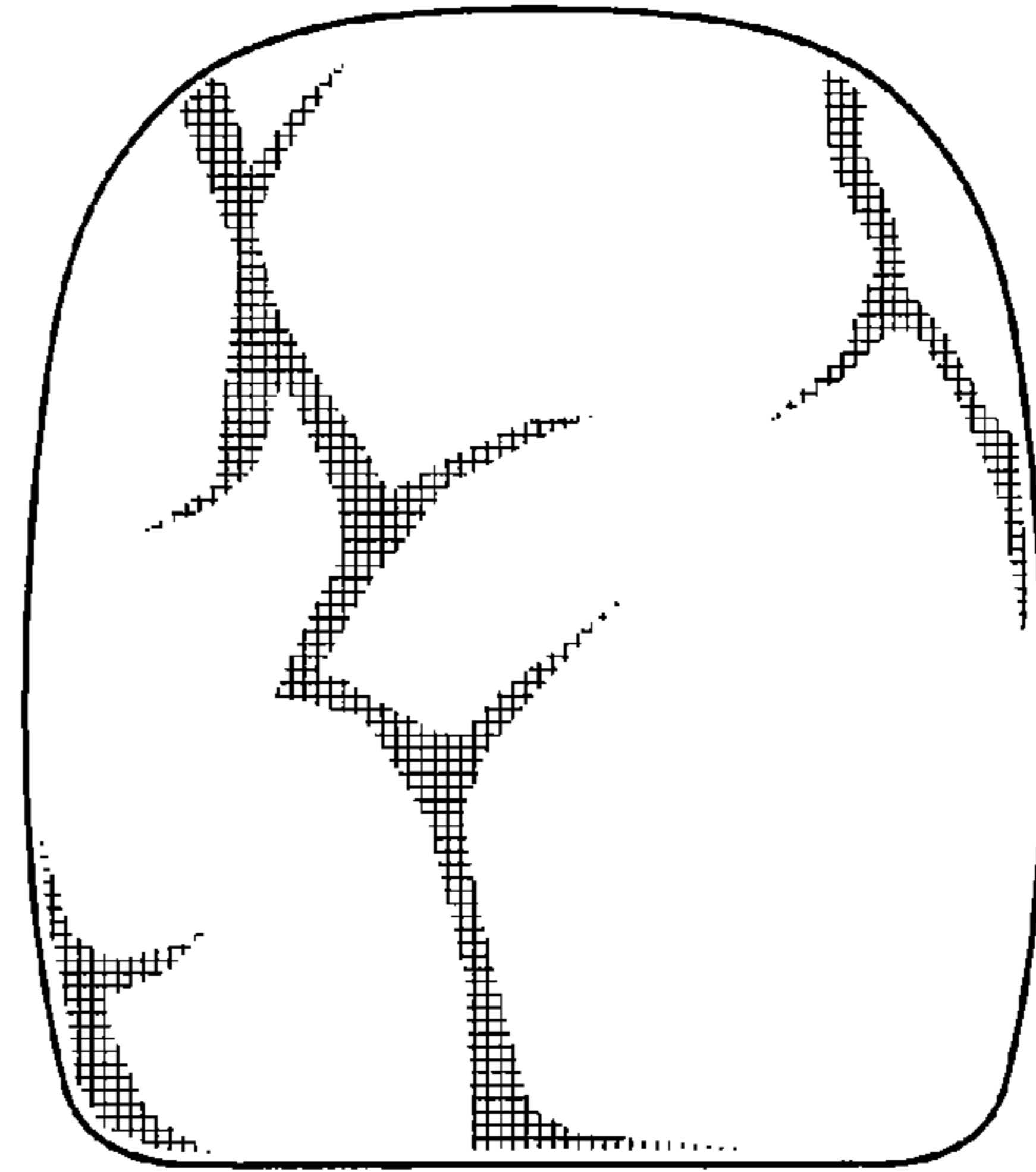

Fig.4

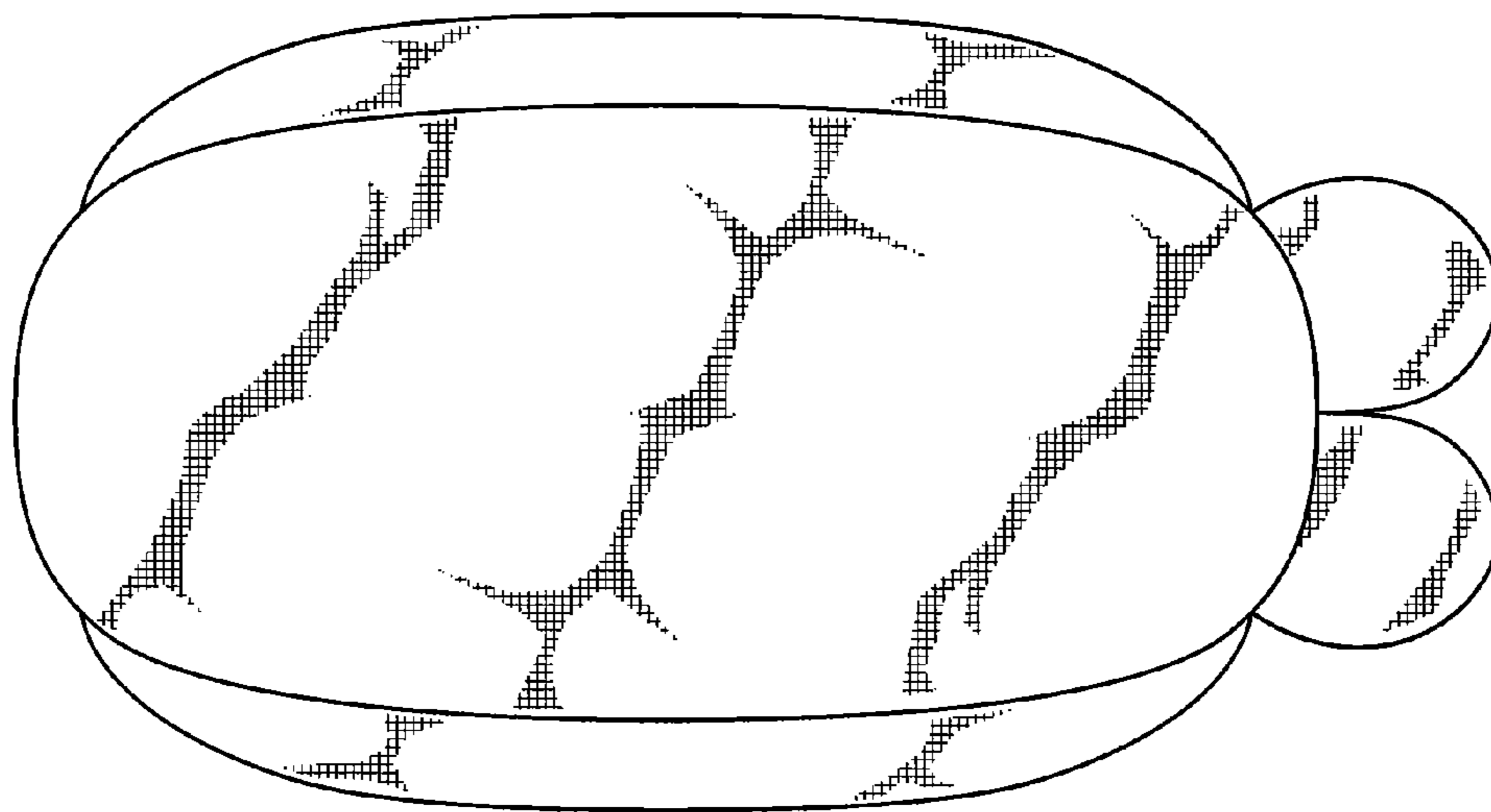

Fig.5