



US00D550456S

(12) **United States Design Patent** (10) **Patent No.:** **US D550,456 S**
Keen (45) **Date of Patent:** **** Sep. 11, 2007**

(54) **GOLF CLUB HOLDER**

(76) Inventor: **Donald G Keen**, 101 Temple Ter.,
Clarksburg, WV (US) 26301

(**) Term: **14 Years**

(21) Appl. No.: **29/225,821**

(22) Filed: **Mar. 21, 2005**

(51) **LOC (8) Cl.** **03-01**

(52) **U.S. Cl.** **D3/259; D3/328.1; D21/796**

(58) **Field of Classification Search** D3/254–255,
D3/259, 320, 328.1, 904; D21/789, 796;
206/315.2–315.7, 579; 211/70.2; 248/96–97,
248/156; 294/159

See application file for complete search history.

(56) **References Cited**

U.S. PATENT DOCUMENTS

699,391	A *	5/1902	Johnson	211/70.2
1,452,084	A *	4/1923	Lockett	206/315.7
1,849,803	A *	3/1932	Pedersen	248/96
1,926,184	A *	9/1933	Schwer	248/96
2,595,987	A *	5/1952	Shears	206/315.6
2,970,629	A *	2/1961	Masten	206/315.2
3,465,993	A *	9/1969	Muehlhausen	248/96
3,593,766	A *	7/1971	Harmon et al.	206/315.7
D232,449	S *	8/1974	Herring	D3/259
3,866,646	A	2/1975	Nevard		
D237,396	S *	10/1975	Herring	D3/259
5,102,529	A	4/1992	Hickin		
D341,717	S	11/1993	Hickin		
5,314,079	A	5/1994	Young		
D351,444	S *	10/1994	Hunter	D21/796
5,425,452	A	6/1995	Shanks et al.		
5,450,954	A	9/1995	Dunn		

D372,126	S *	7/1996	Martinez et al.	D3/320
D374,986	S	10/1996	Dages		
D399,347	S *	10/1998	Larko et al.	D3/259
D433,566	S	11/2000	Larko		
6,383,088	B1 *	5/2002	Kershner	473/282
D472,598	S *	4/2003	Lawrence	D21/796
D476,479	S *	7/2003	Bailey	D3/254
D486,875	S *	2/2004	Hale et al.	D21/796
D497,192	S *	10/2004	Radford	D21/796

* cited by examiner

Primary Examiner—Philip S. Hyder

Assistant Examiner—RoseLynne (Ulm) Cody

(74) *Attorney, Agent, or Firm*—John J. Giblin; Bowles Rice
McDavid Graff & Love LLP

(57) **CLAIM**

The ornamental design for a golf club holder, as shown and described.

DESCRIPTION

FIG. 1 is a perspective view from the left front of the golf club holder.

FIG. 2 is a perspective view from the right front of the golf club holder.

FIG. 3 is a left elevation view of the golf club holder.

FIG. 4 is a front elevation view of the golf club holder.

FIG. 5 is a right elevation view of the golf club holder.

FIG. 6 is a right elevation view of the golf club holder.

FIG. 7 is a top plan view of the golf club holder; and,

FIG. 8 is a bottom perspective view of the golf club holder.

1 Claim, 7 Drawing Sheets

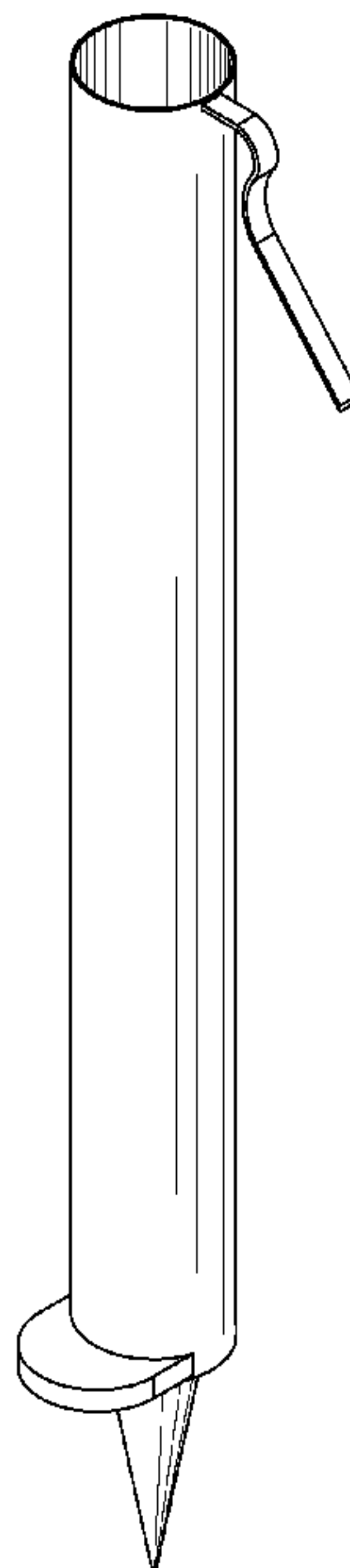

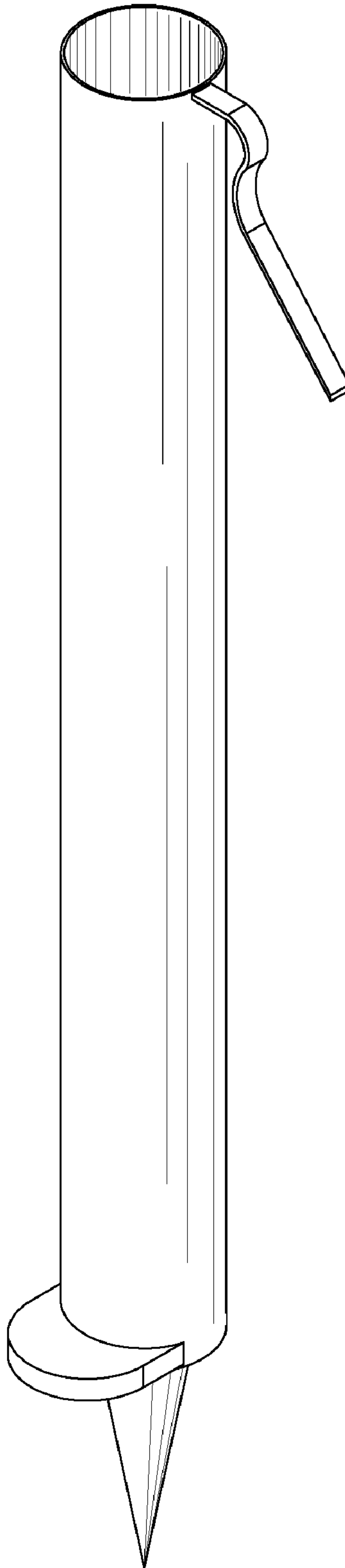

Fig. 1

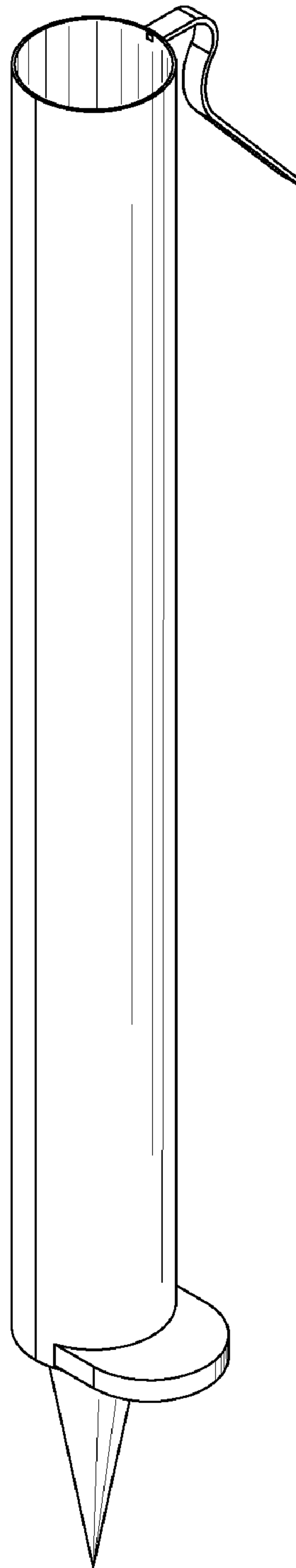

Fig. 2

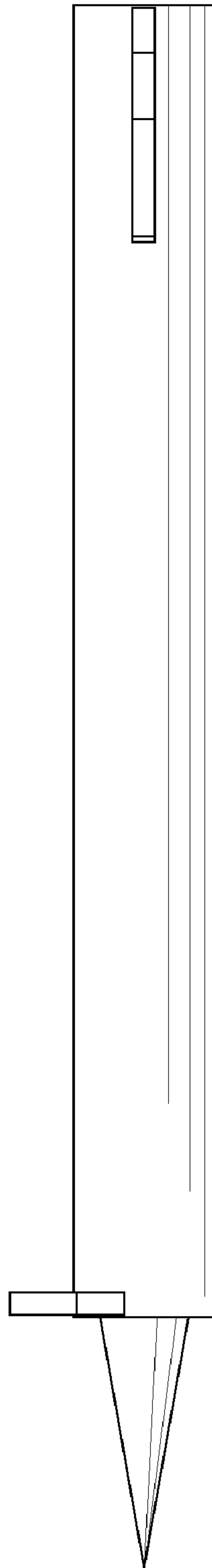

Fig. 3

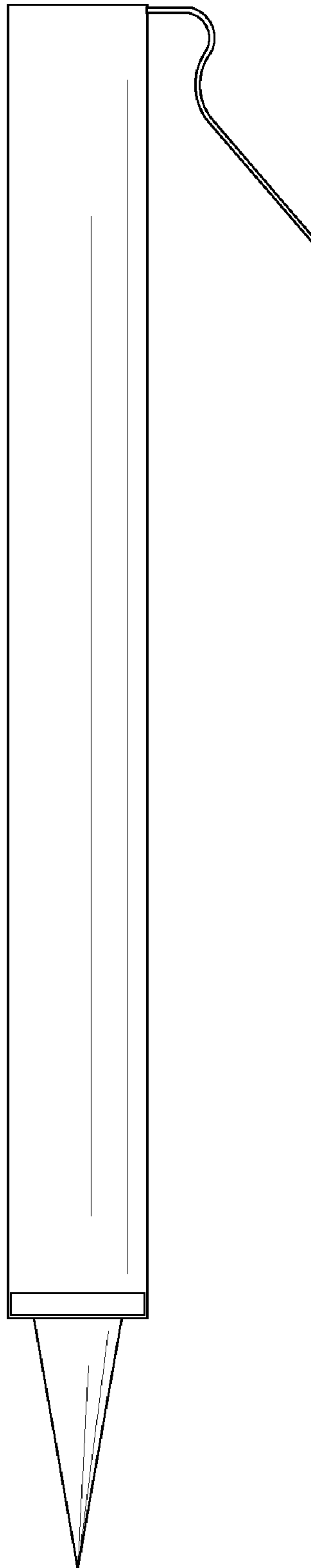

Fig. 4

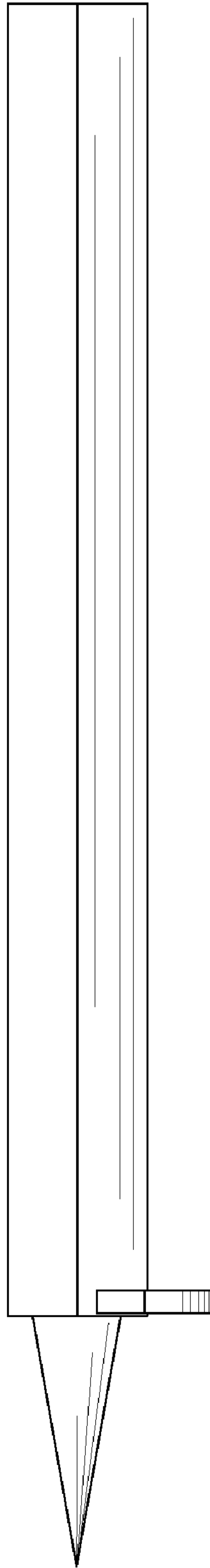

Fig. 5

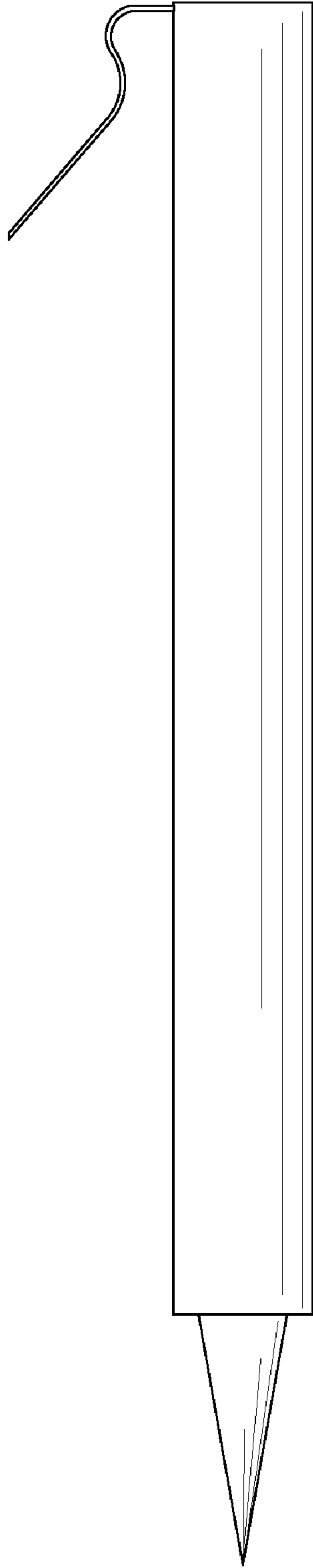

Fig. 6

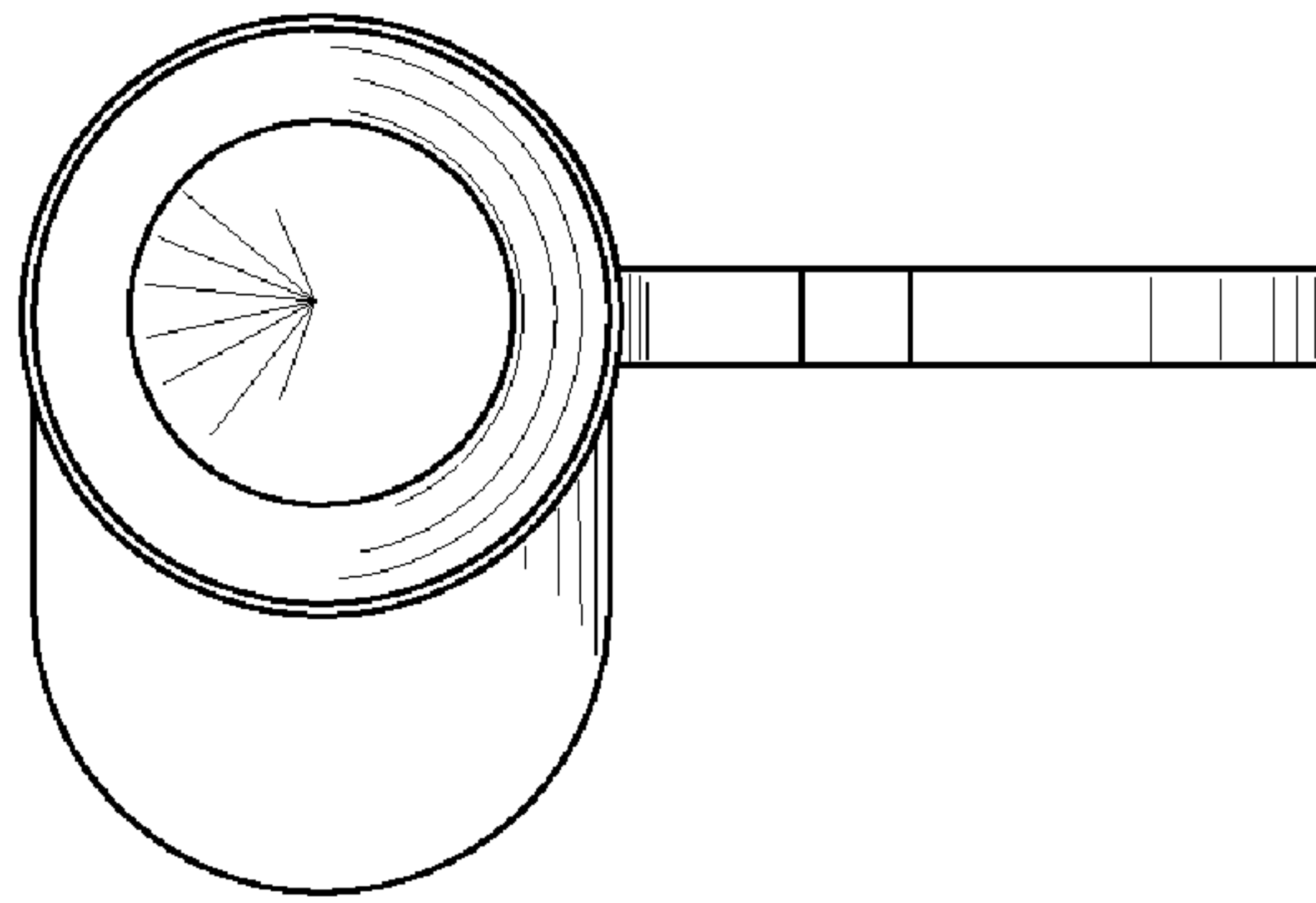

Fig. 7

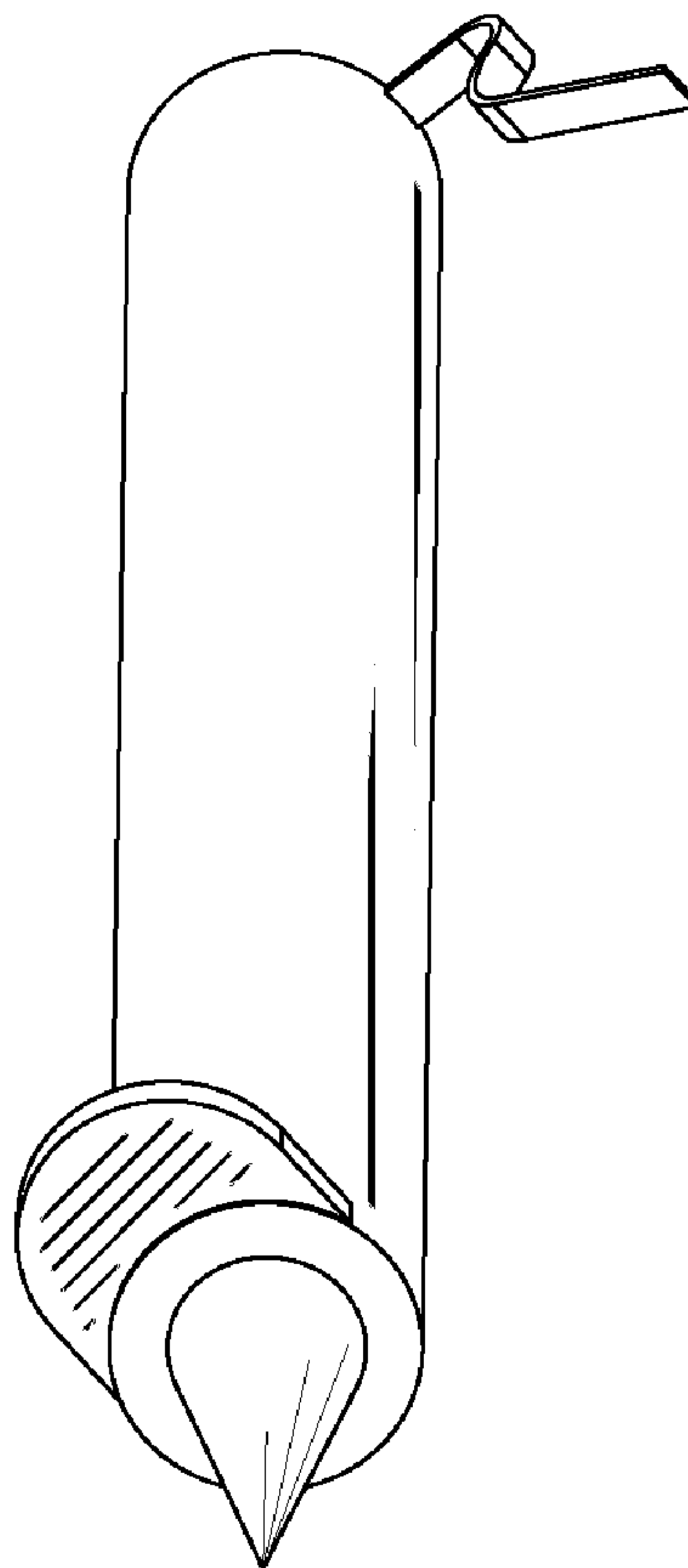

Fig. 8