



US00D550264S

(12) **United States Design Patent**
Chan

(10) **Patent No.:** **US D550,264 S**

(45) **Date of Patent:** **** Sep. 4, 2007**

(54) **LED FOLDING MAGNIFIER**

(75) Inventor: **Yau Hon Chan**, Hong Kong (HK)

(73) Assignee: **Poly Link Hong Kong**, Hong Kong (HK)

(**) Term: **14 Years**

(21) Appl. No.: **29/251,155**

(22) Filed: **Jan. 4, 2006**

(51) **LOC (8) Cl.** **16-06**

(52) **U.S. Cl.** **D16/135**

(58) **Field of Classification Search** D16/130,
D16/135; D26/36, 44, 51; 248/471, 688;
359/802, 803, 805, 808, 810, 812; 362/109,
362/157, 253; 345/156-167

See application file for complete search history.

(56) **References Cited**

U.S. PATENT DOCUMENTS

153,983	A	*	8/1874	Ronty	248/471
2,384,528	A	*	9/1945	Brandt et al.	359/803
D171,904	S	*	4/1954	Cacalubo, Jr.	D16/135
D298,634	S	*	11/1988	Yuen	D16/135
D406,853	S	*	3/1999	Chan	D16/135
D483,780	S	*	12/2003	Overholser	D16/135
D490,453	S	*	5/2004	Passarella et al.	D16/135
D502,719	S	*	3/2005	Yip et al.	D16/135
D520,164	S	*	5/2006	Brass et al.	D26/44

* cited by examiner

Primary Examiner—Paula A. Greene

(74) *Attorney, Agent, or Firm*—Lilling & Lilling PLLC;
Bruce E. Lilling; Sean Liam Kulleher

(57) **CLAIM**

The ornamental design for a LED folding magnifier, as shown.

DESCRIPTION

FIG. 1 is a perspective view of my new and novel design with the handle extended

FIG. 2 is a perspective view of my new and novel design with the handle folded

FIG. 3 is a front view of my new and novel design with the handle extended

FIG. 4 is a front view of my new and novel design with the handle folded

FIG. 5 is a rear view of my new and novel design with the handle extended

FIG. 6 is a top view of my new and novel design with the handle extended

FIG. 7 is a Bottom view of my new and novel design with the handle extended

FIG. 8 is a left-side view of my new and novel design with the handle folded

FIG. 9 is a top view of my new and novel design with the handle folded

FIG. 10 is a Bottom view of my new and novel design with the handle folded

FIG. 11 is a left-side view of my new and novel design with the handle folded

FIG. 12 is a right-side view of my new and novel design with the handle folded; and,

FIG. 13 is a rear view of my new and novel design with the handle extended.

1 Claim, 4 Drawing Sheets

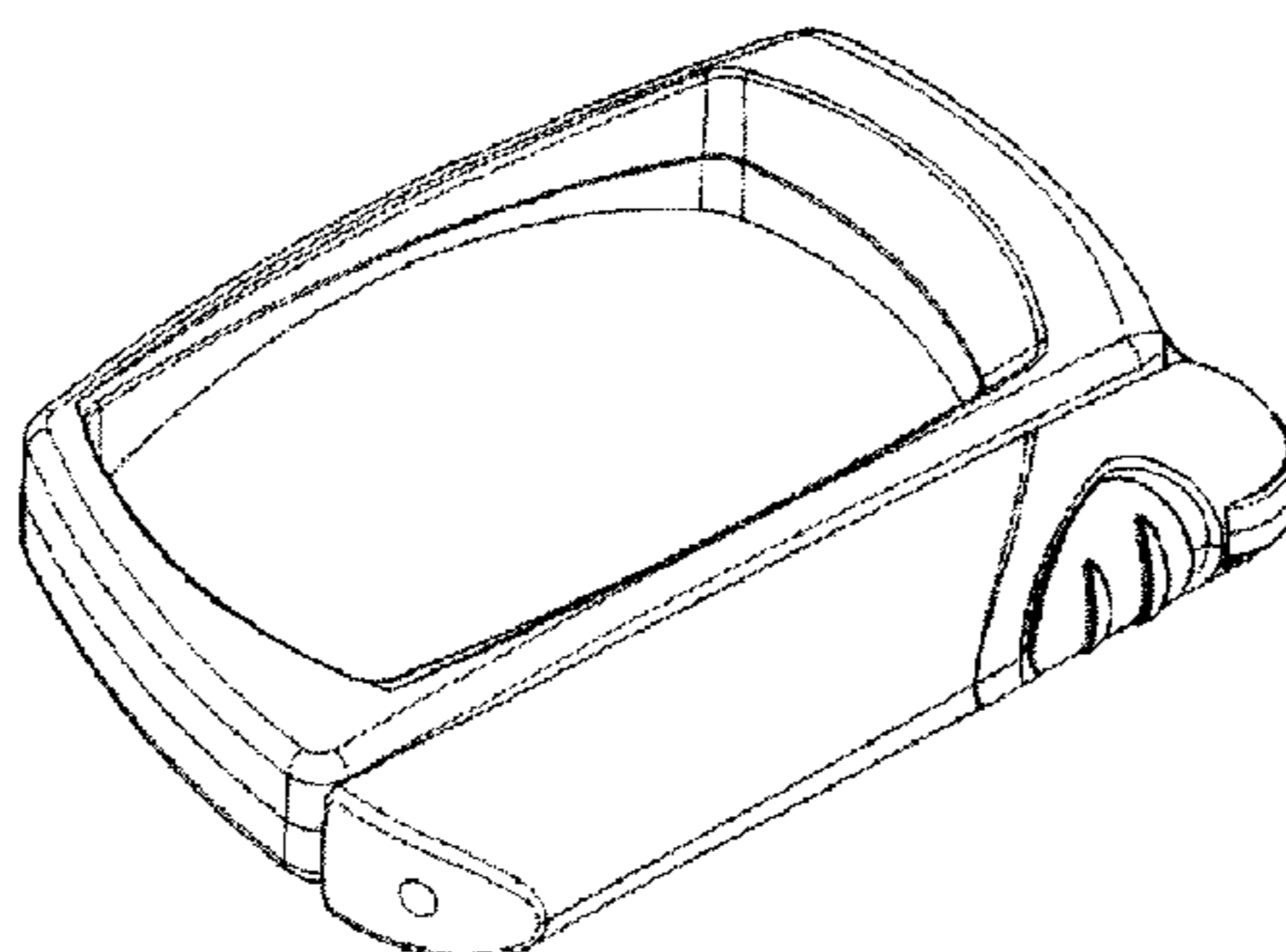
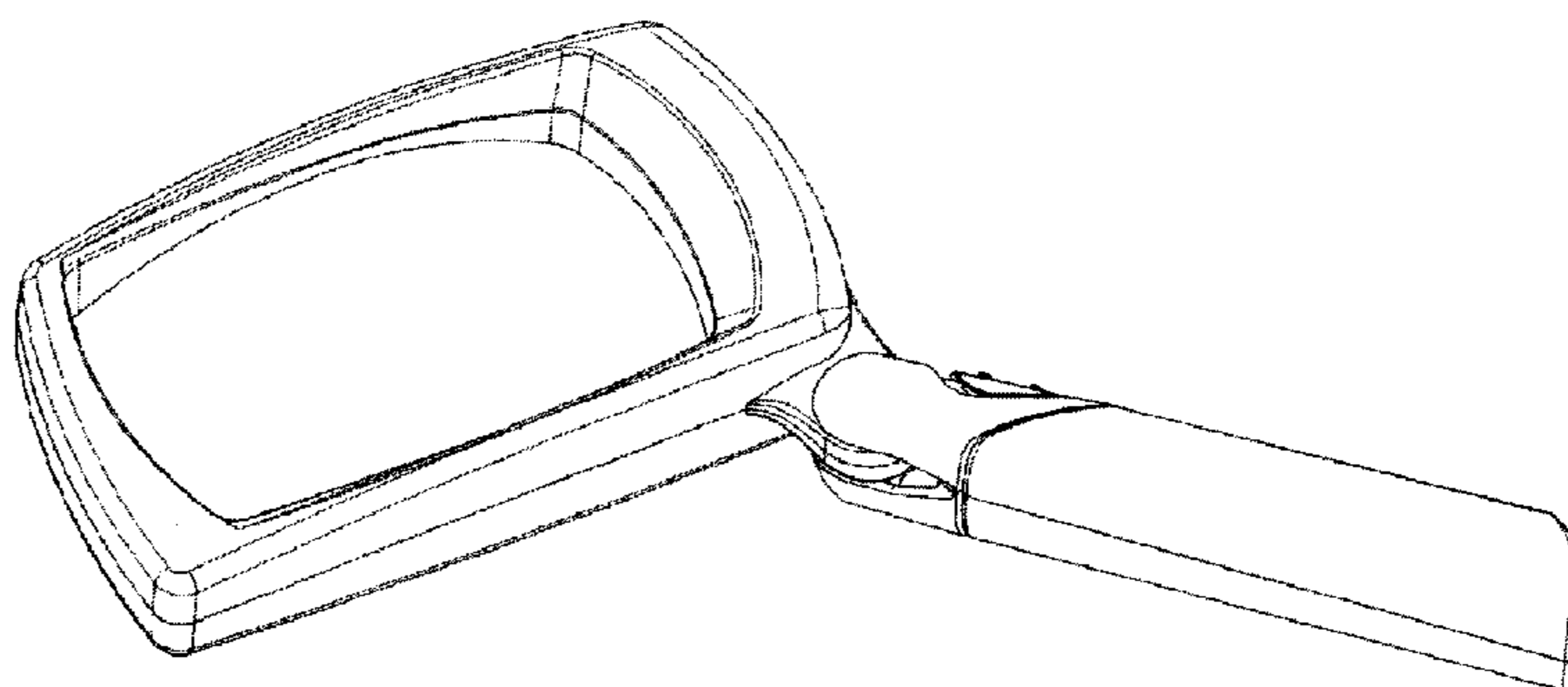

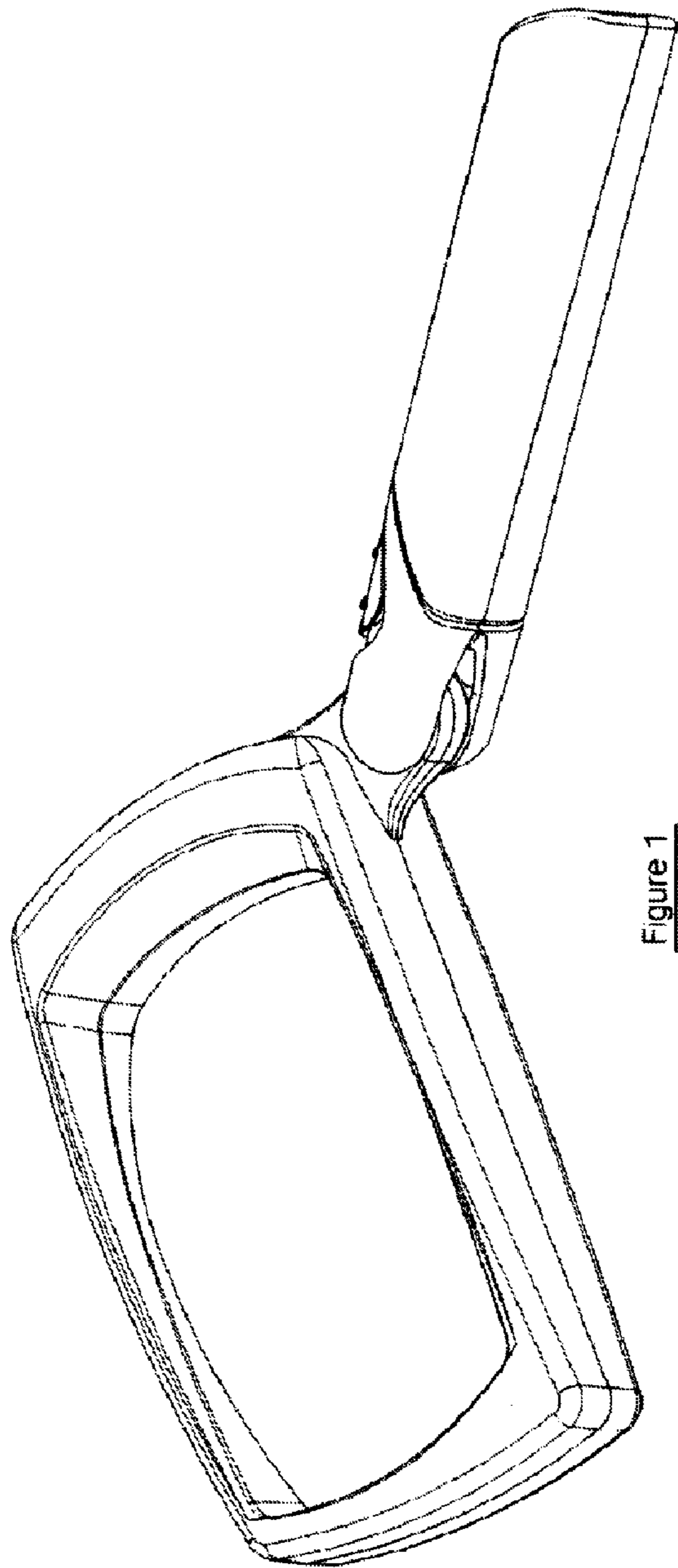

Figure 1

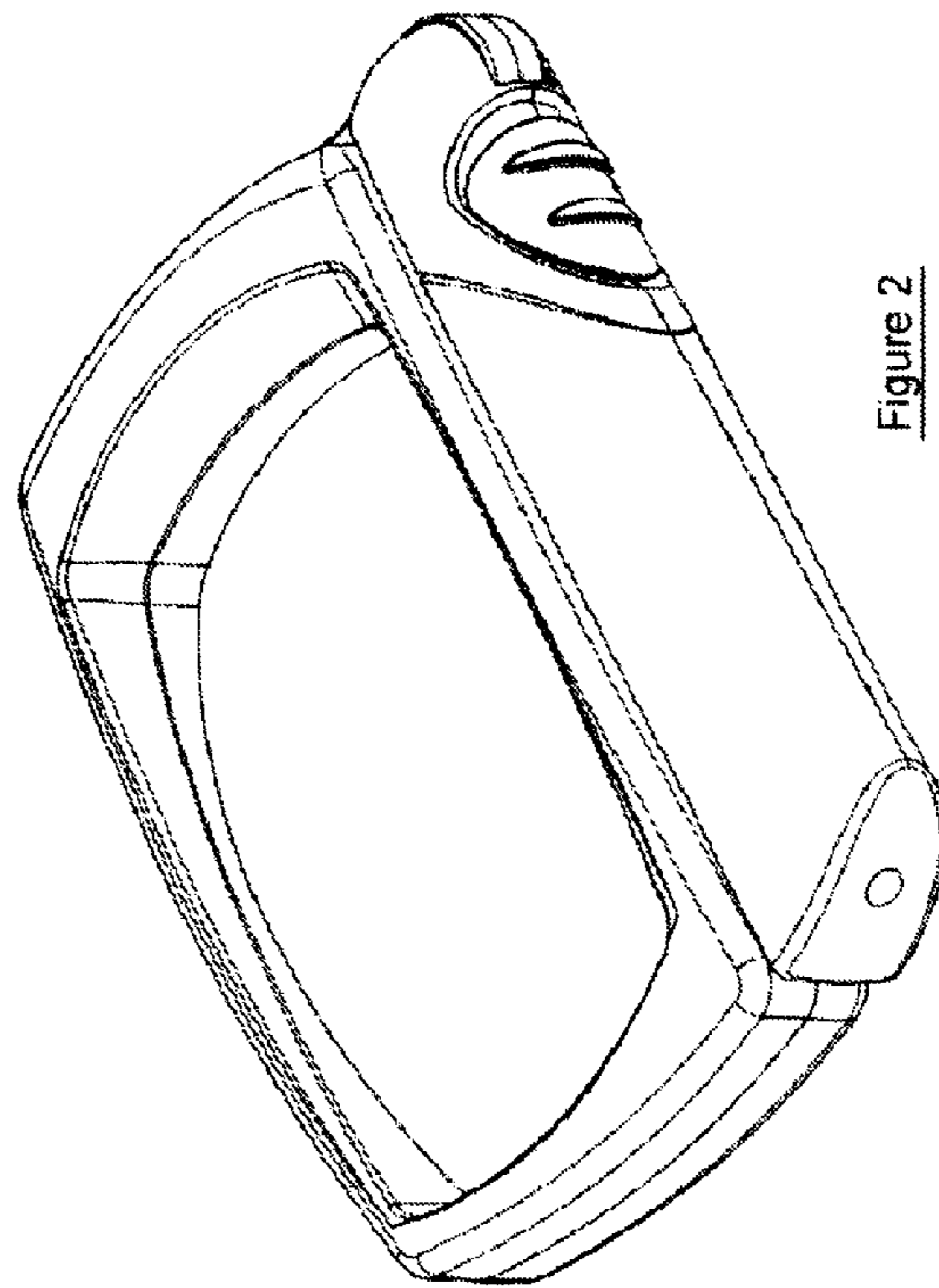

Figure 2

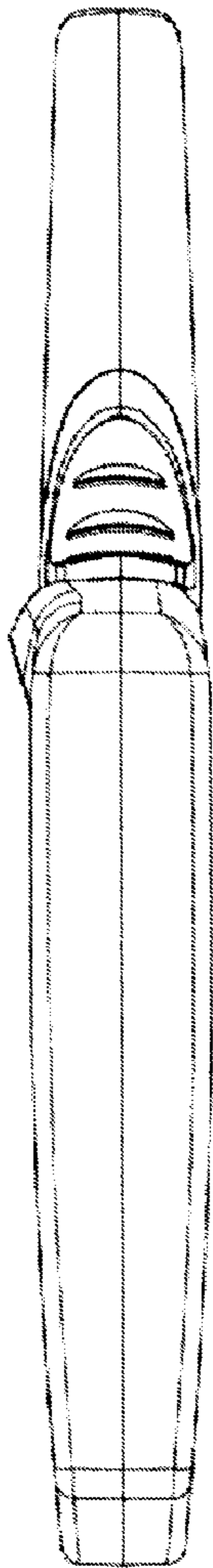

Figure 5

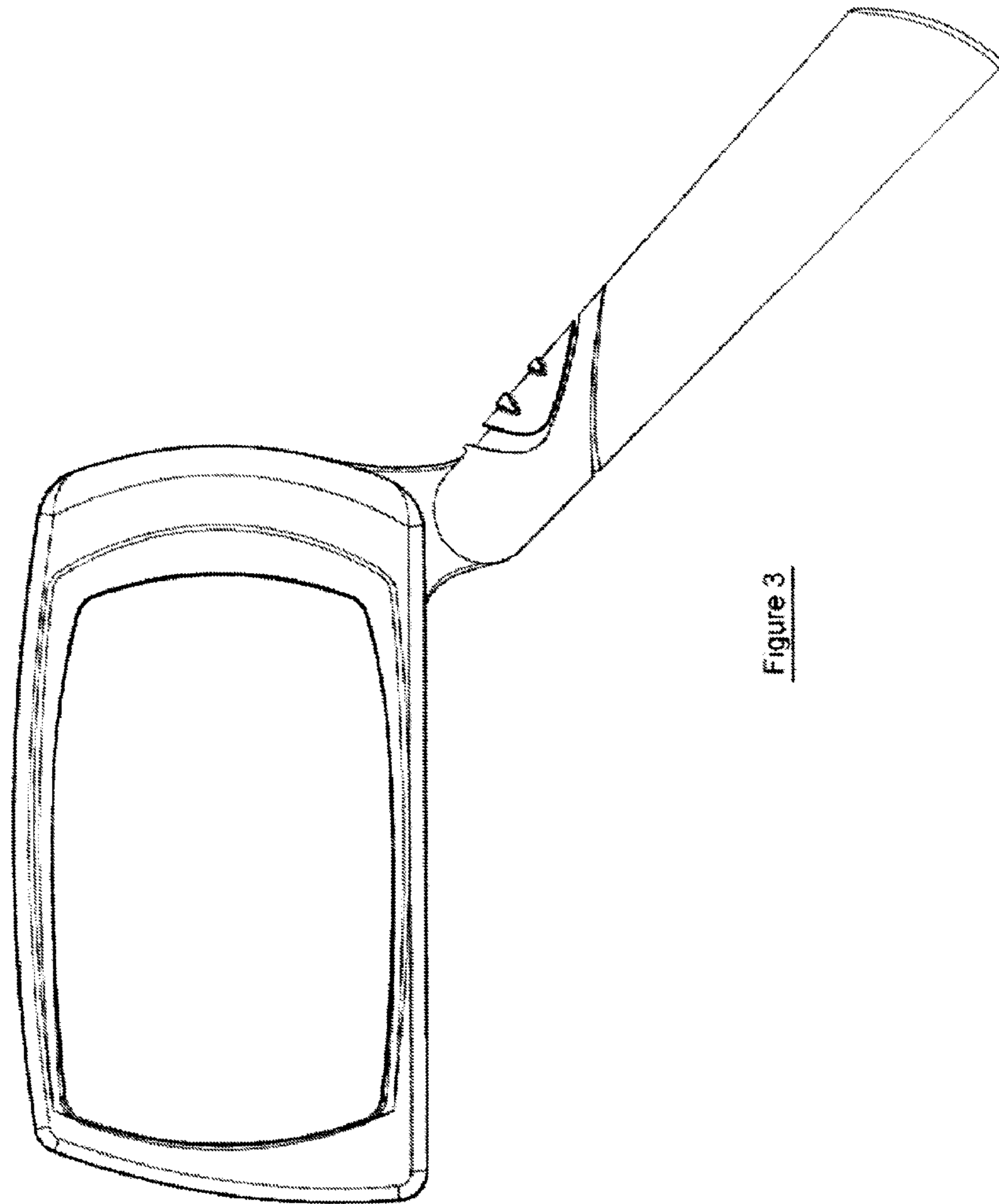

Figure 3

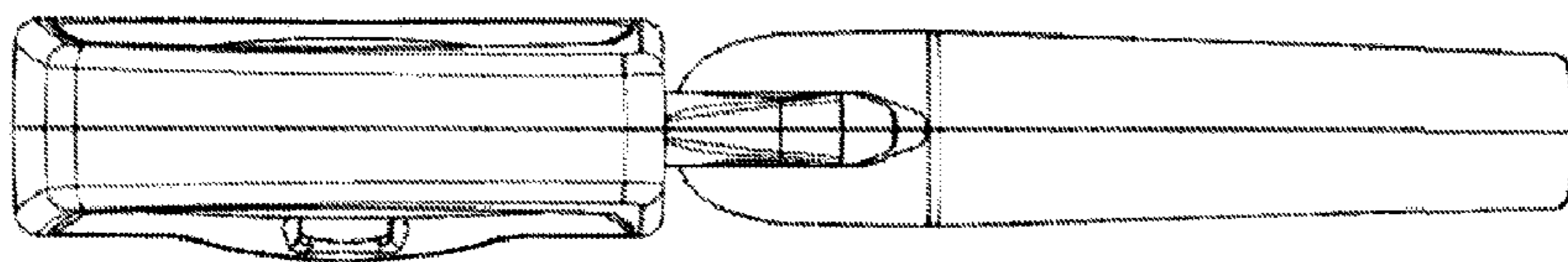

Figure 7

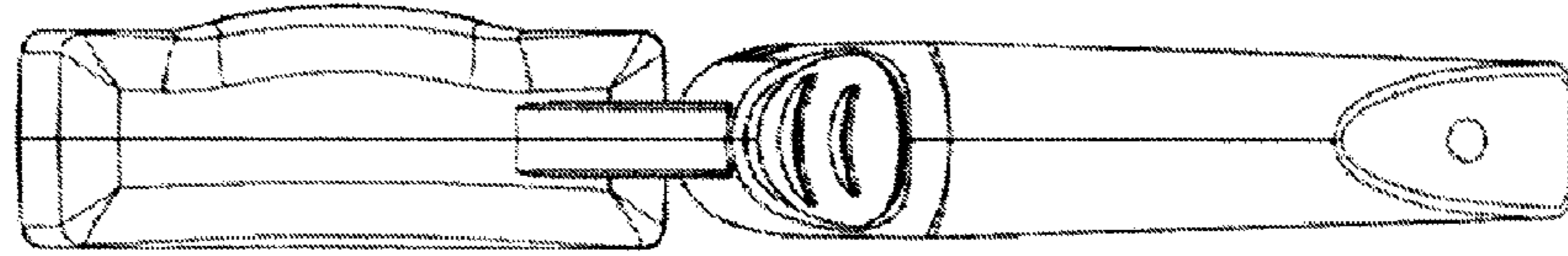

Figure 8

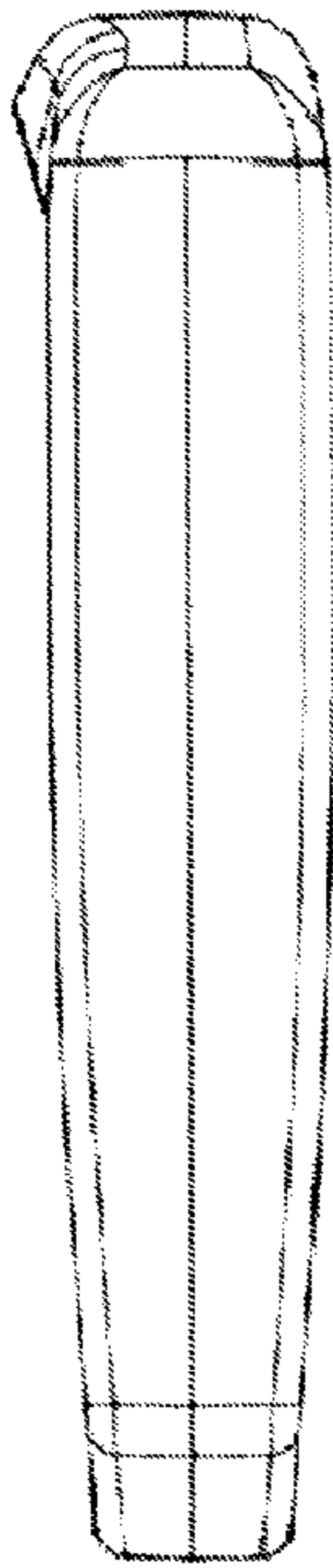

Figure 9

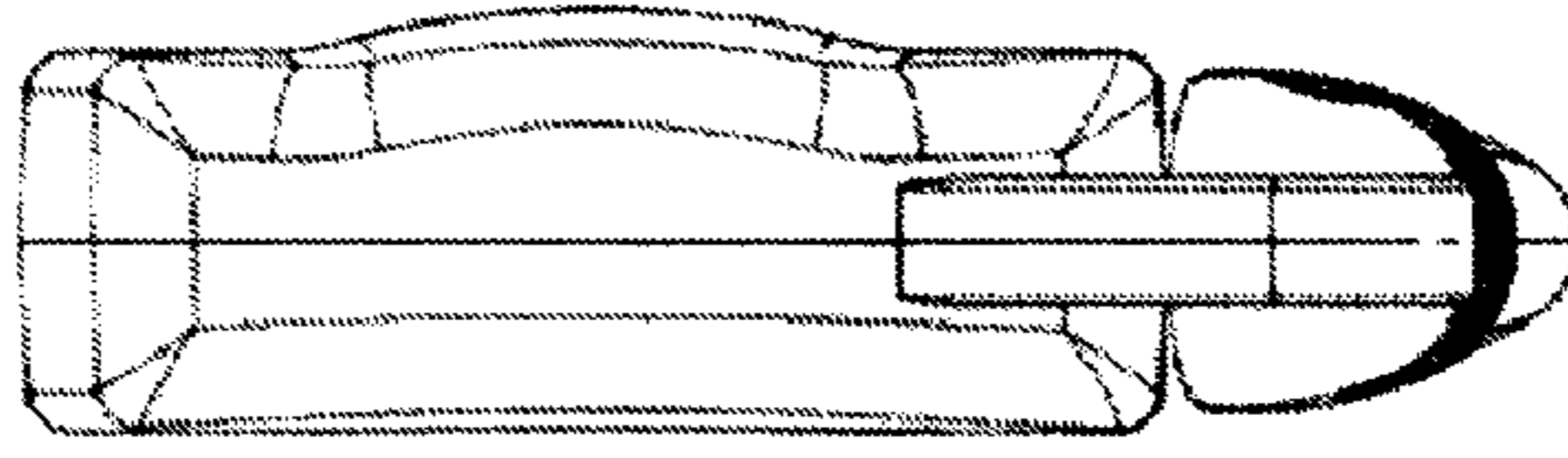

Figure 12

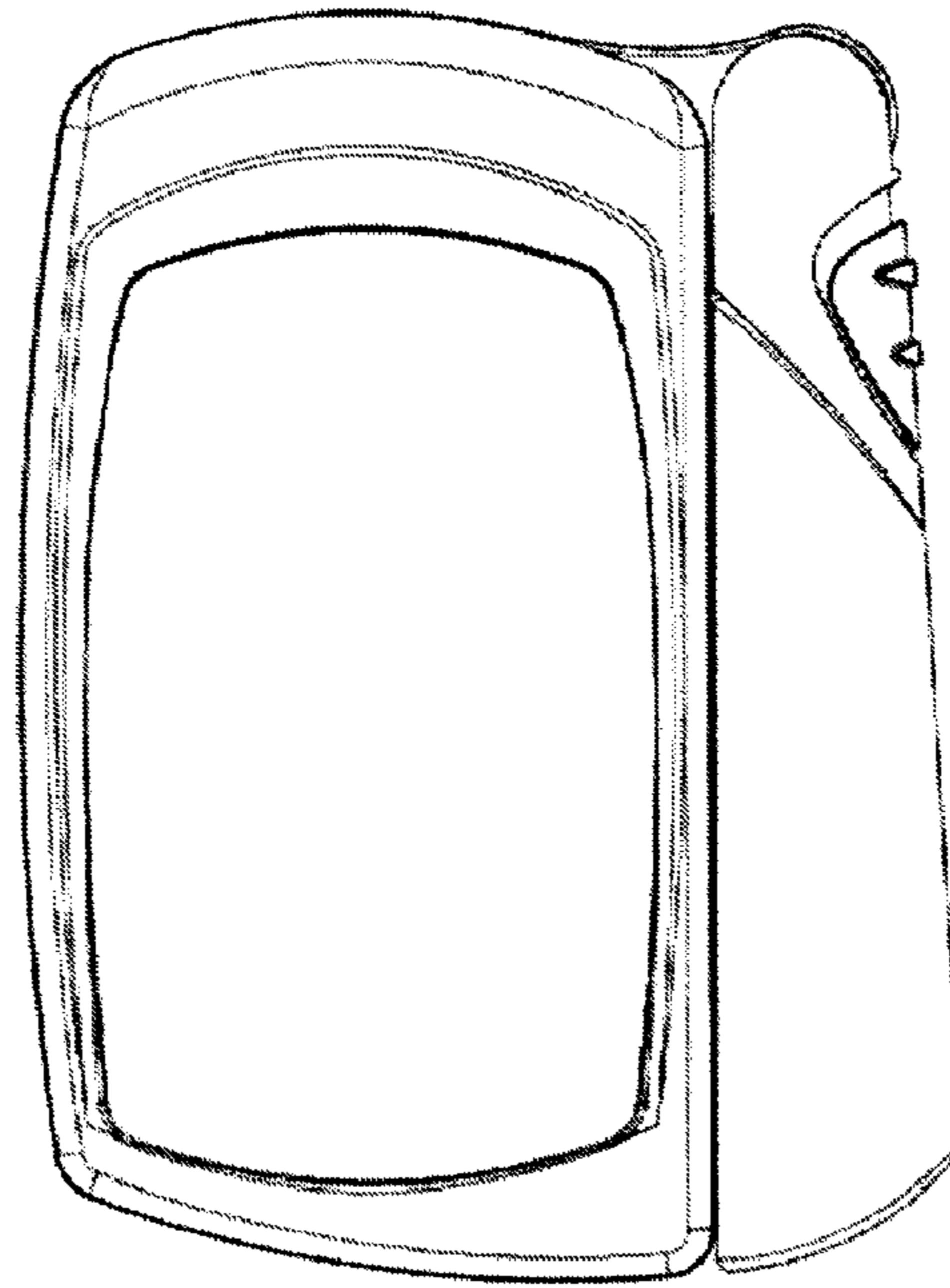

Figure 4

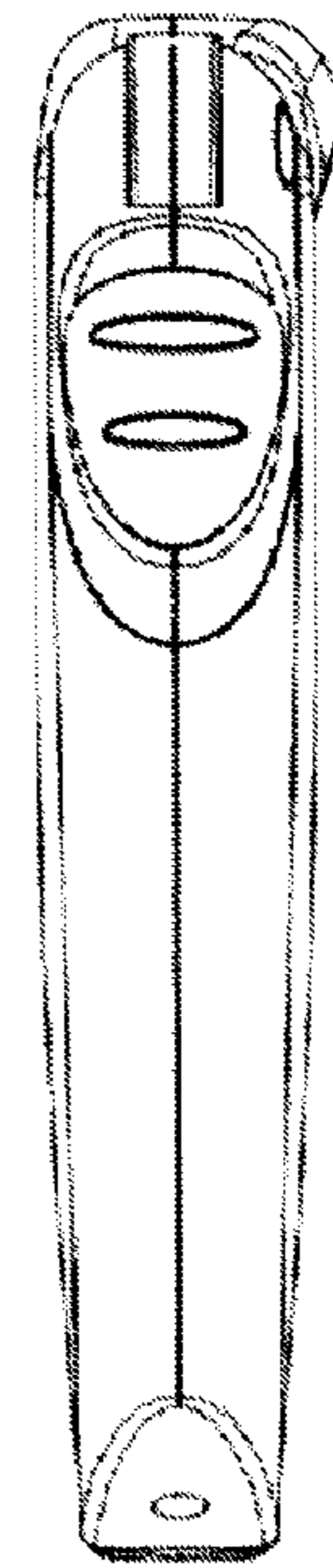

Figure 10

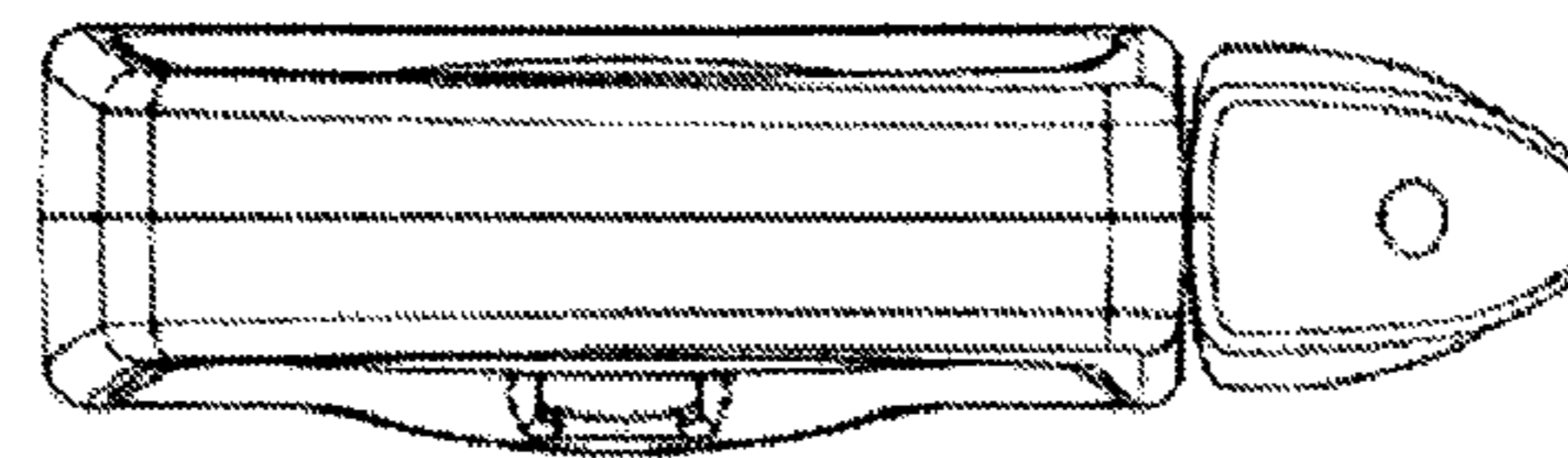

Figure 11

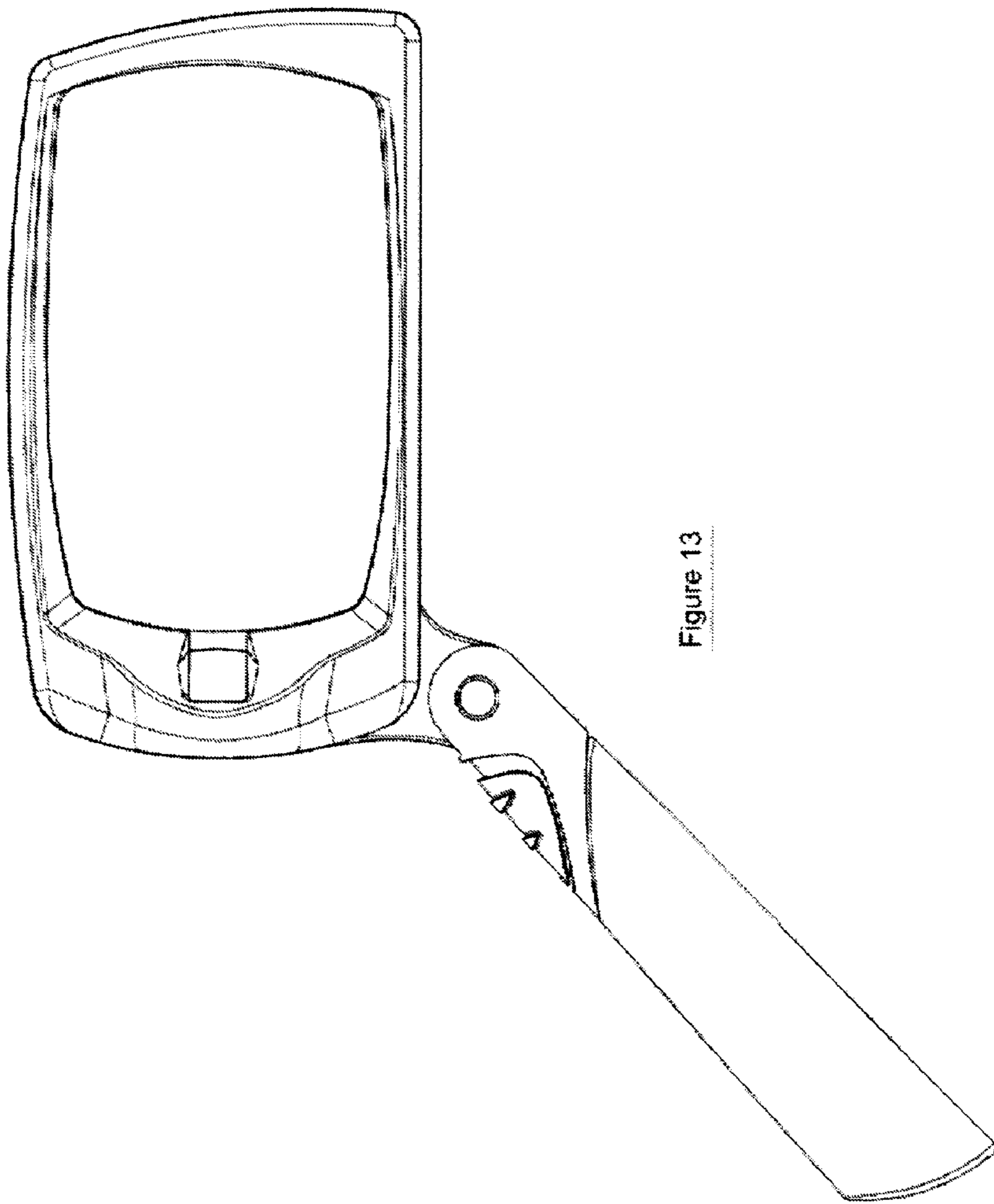

Figure 13

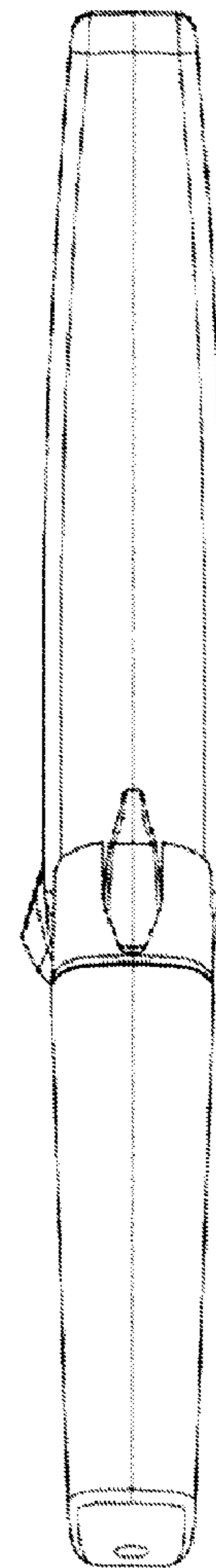

Figure 6