



US00D550201S

(12) **United States Design Patent** (10) **Patent No.:** **US D550,201 S**
Drambarean et al. (45) **Date of Patent:** **** Sep. 4, 2007**

(54) **EARPHONE**

(75) Inventors: **Viorel Drambarean**, Skokie, IL (US);
Andrew J. Haapapuro, Arlington Heights, IL (US); **Mead C. Killion**, Elk Grove Village, IL (US)

(73) Assignee: **Etymotic Research, Inc.**, Elk Grove Village, IL (US)

(**) Term: **14 Years**

(21) Appl. No.: **29/247,977**

(22) Filed: **Jul. 24, 2006**

(51) **LOC (8) Cl.** **14-01**

(52) **U.S. Cl.** **D14/205; D14/223**

(58) **Field of Classification Search** D14/192,
D14/218, 205-206, 223; 181/128-129, 130-132,
181/135, 137, 322, 380; D24/106, 174; 379/430-431,
379/444; 381/312, 322, 328, 338, 380;
600/474, 549

See application file for complete search history.

(56) **References Cited**

U.S. PATENT DOCUMENTS

4,375,016	A *	2/1983	Harada	181/135
4,588,867	A *	5/1986	Konomi	379/430
4,602,642	A *	7/1986	O'Hara et al.	600/474

4,720,857	A *	1/1988	Burris et al.	379/430
5,781,638	A *	7/1998	Hosaka et al.	381/322
5,844,984	A *	12/1998	Yamaguchi et al.	379/430
5,991,652	A *	11/1999	Barthelemy et al.	600/474
D455,835	S *	4/2002	Anderson et al.	D24/174
6,574,345	B1 *	6/2003	Huang	381/380
D514,551	S *	2/2006	Lee et al.	D14/223
D516,058	S *	2/2006	Garcia	D14/205

* cited by examiner

Primary Examiner—Paula A. Greene

(74) *Attorney, Agent, or Firm*—McAndrews, Held & Malloy, Ltd.

(57) **CLAIM**

The ornamental design for an earphone, as shown and described.

DESCRIPTION

FIG. 1 is a perspective view of an earphone, showing our new design;

FIG. 2 is a front elevation view thereof;

FIG. 3 is a left side elevation view thereof;

FIG. 4 is a right side elevation view thereof;

FIG. 5 is a top plan view thereof; and,

FIG. 6 is a bottom plan view thereof.

1 Claim, 4 Drawing Sheets

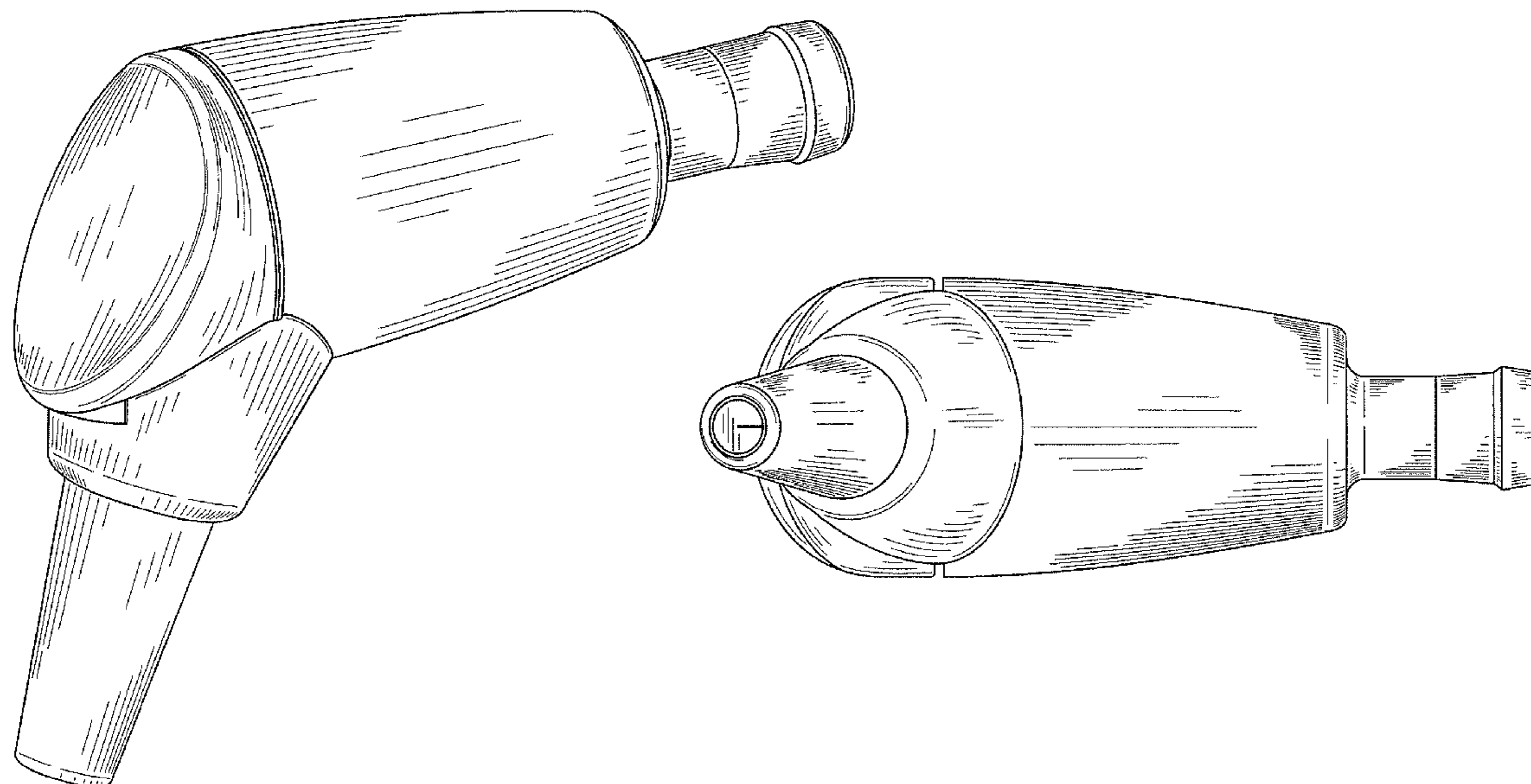

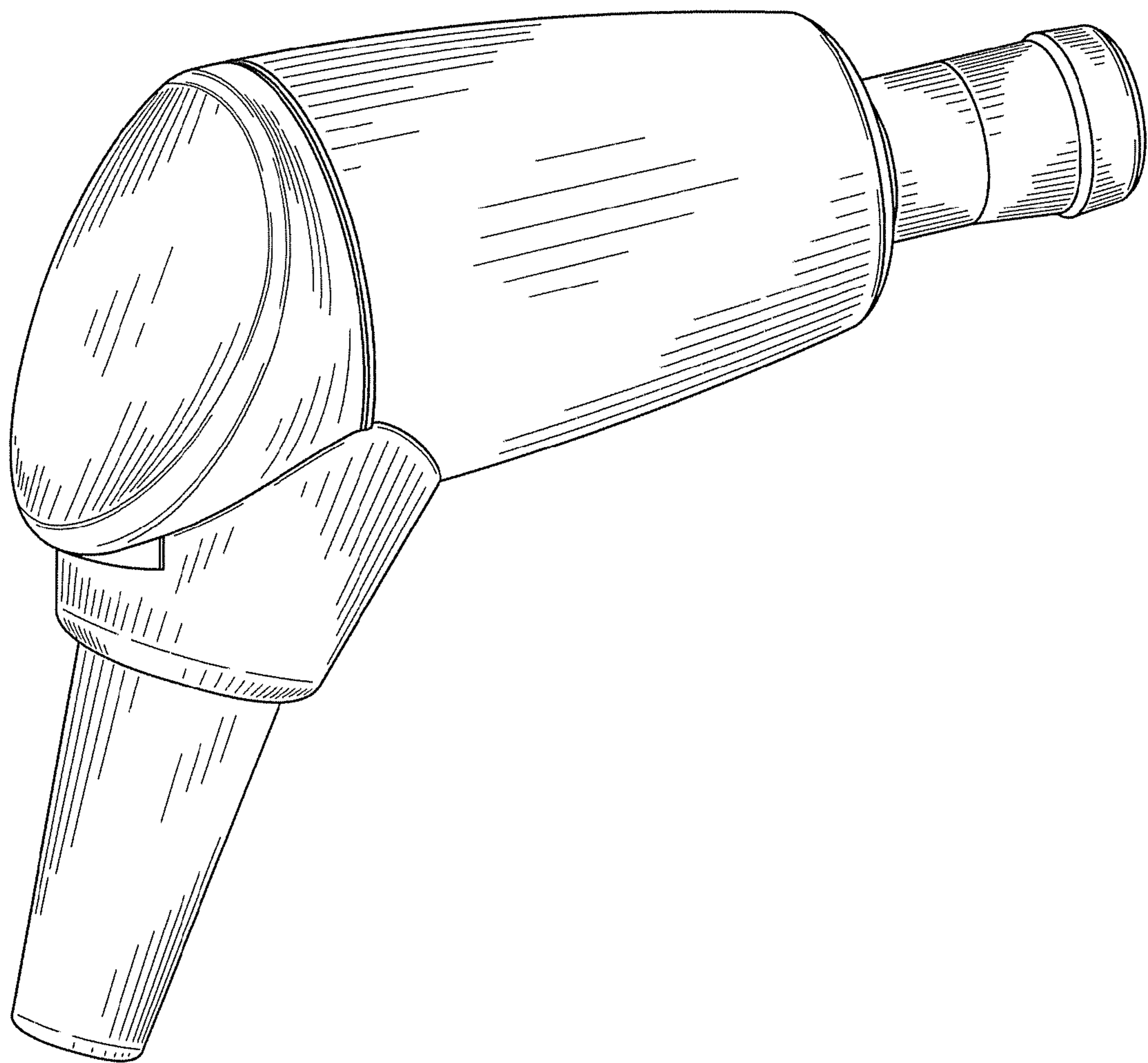

FIG. 1

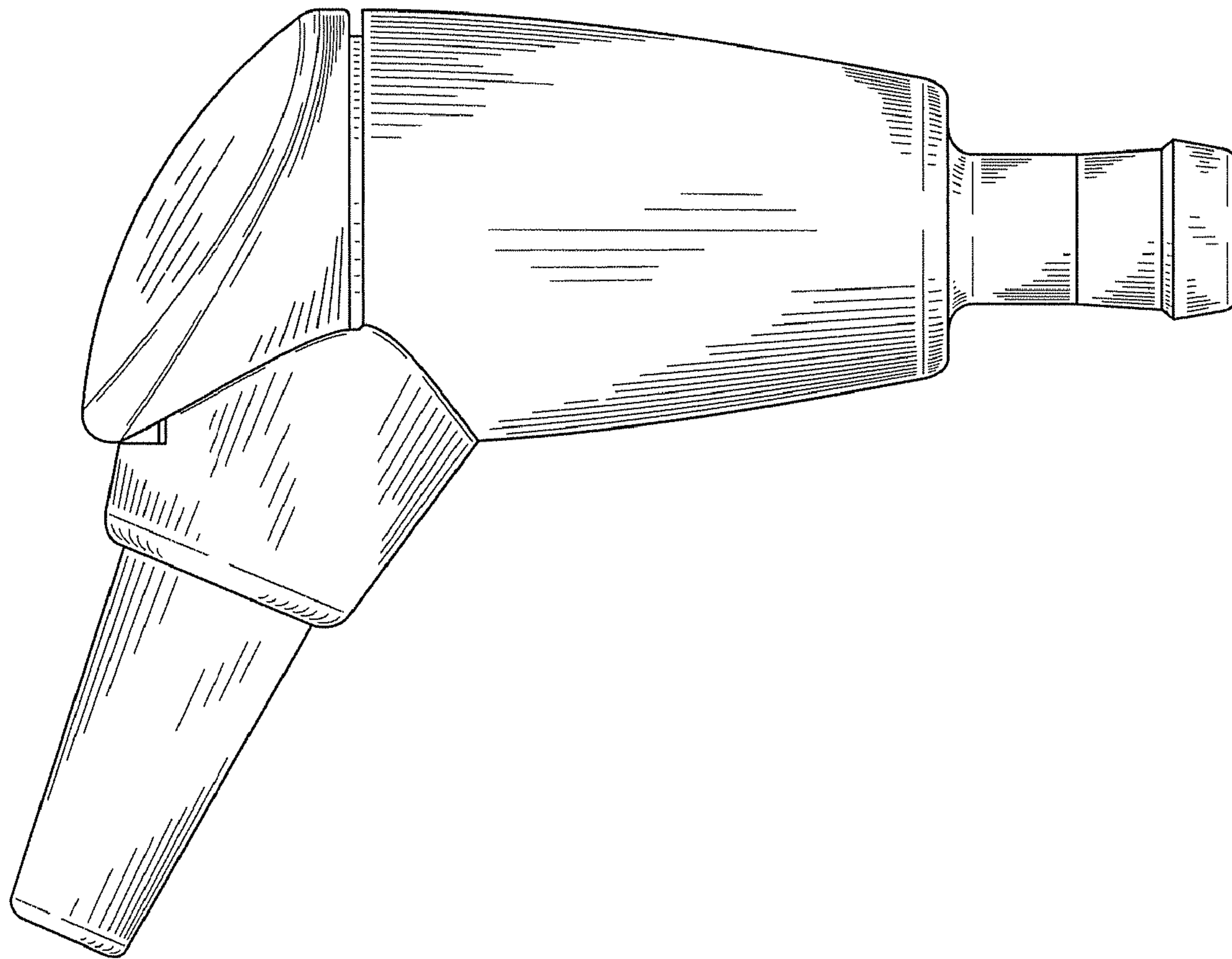

FIG. 2

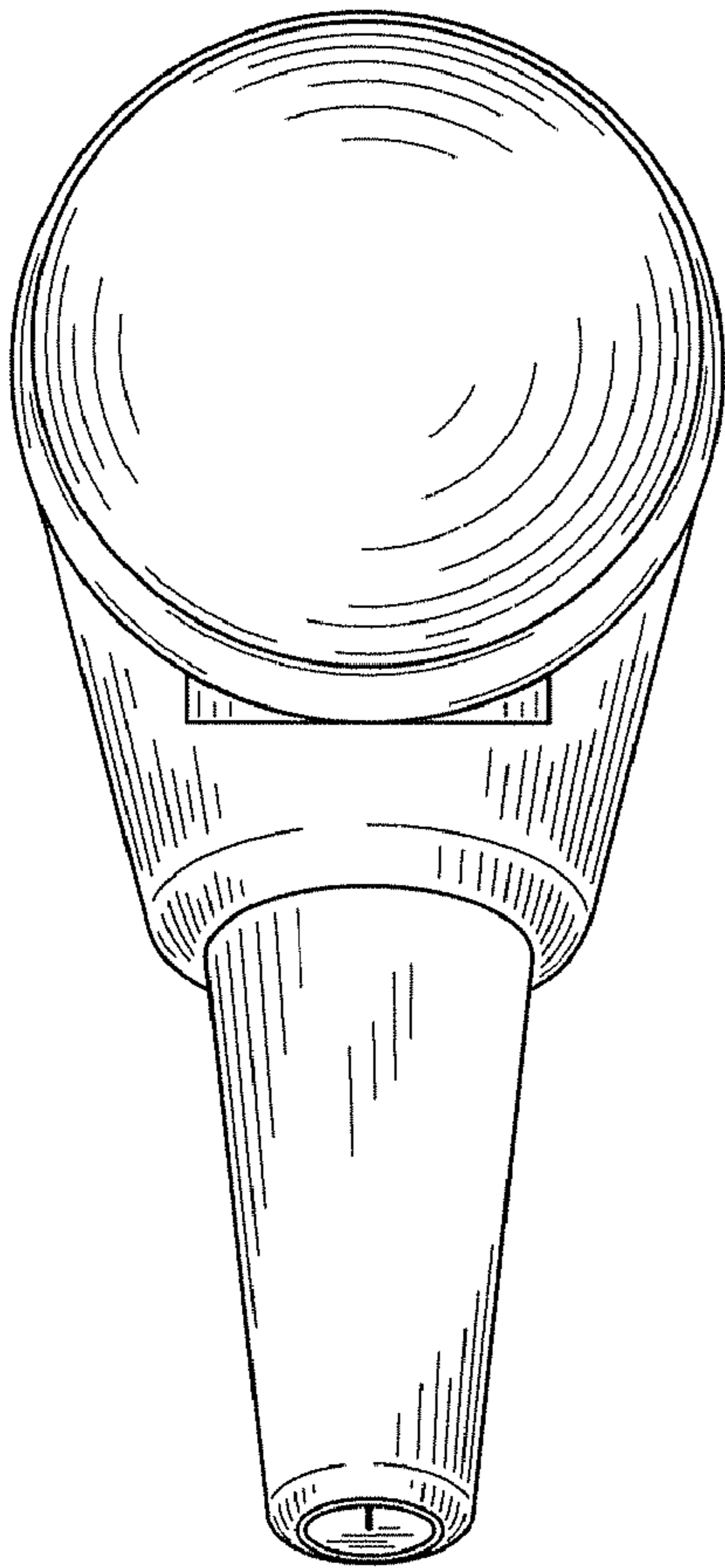

FIG. 3

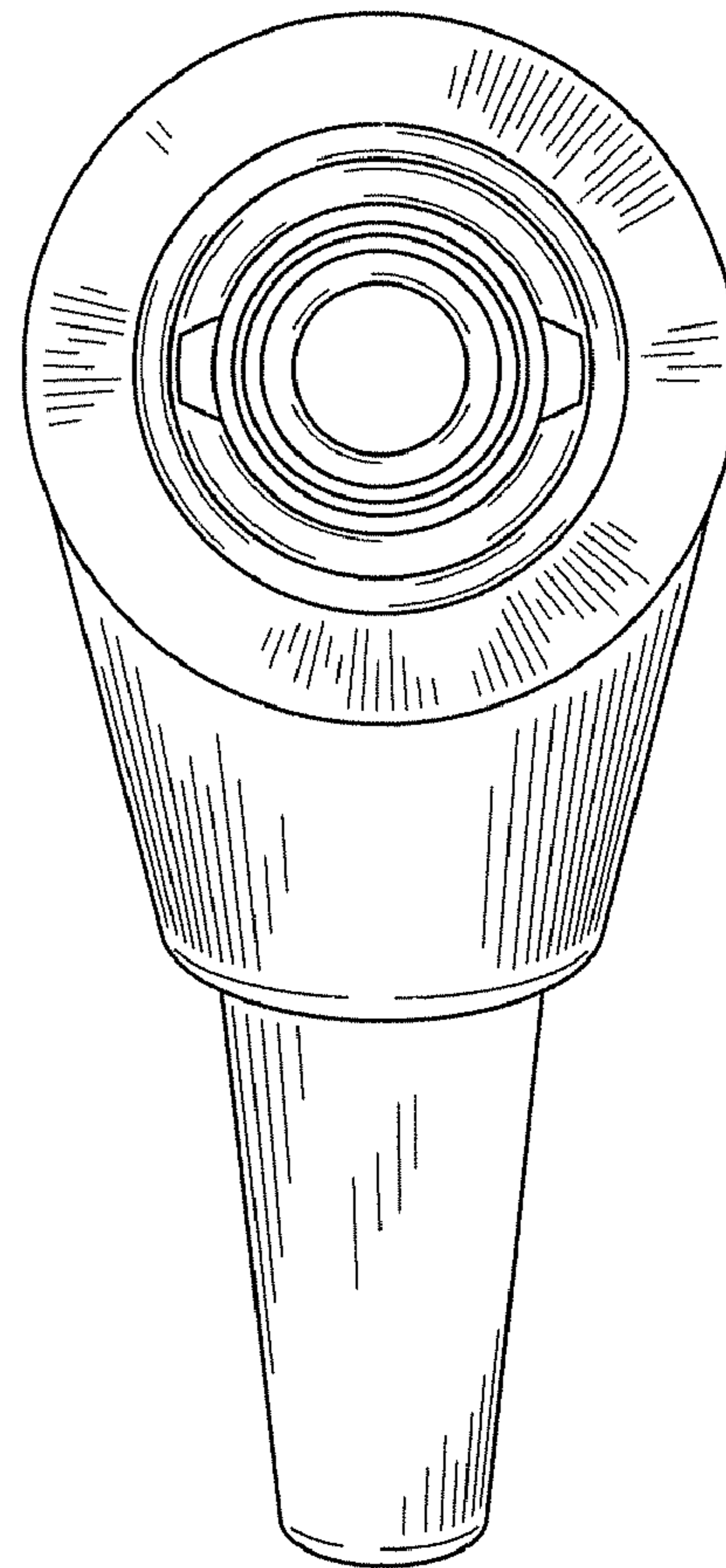

FIG. 4

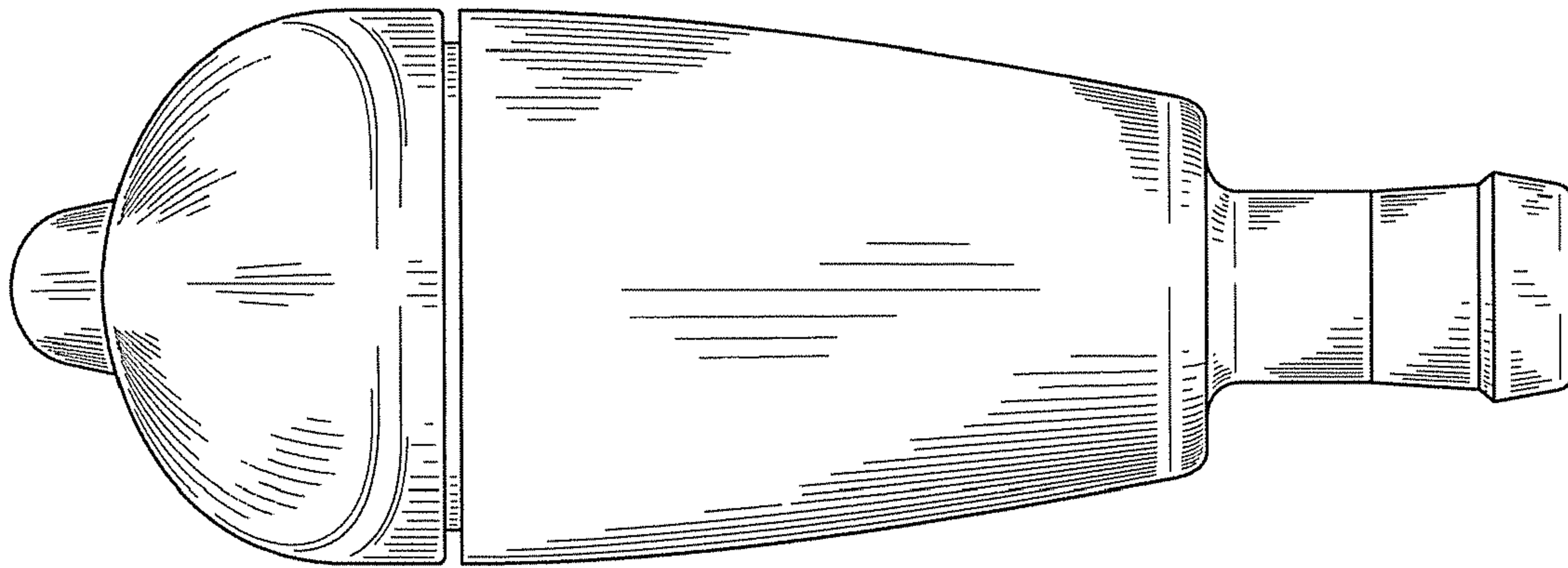

FIG. 5

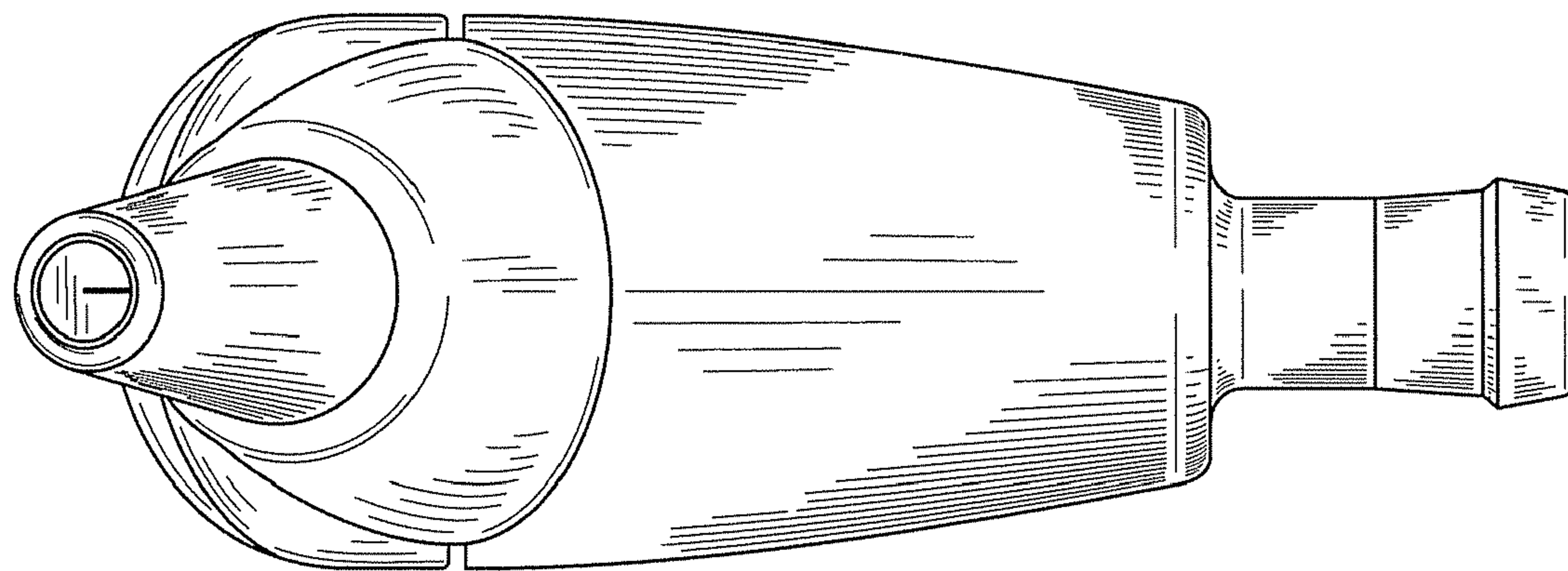

FIG. 6