



US00D550057S

(12) **United States Design Patent**
Staples

(10) **Patent No.:** **US D550,057 S**

(45) **Date of Patent:** **** Sep. 4, 2007**

(54) **HANDLE**

(75) Inventor: **Michael R. Staples**, Mauldin, SC (US)

(73) Assignee: **Professional Tool Products, LLC**,
Greenville, SC (US)

(**) Term: **14 Years**

(21) Appl. No.: **29/276,051**

(22) Filed: **Jan. 12, 2007**

(51) **LOC (8) Cl.** **08-04**

(52) **U.S. Cl.** **D8/107**

(58) **Field of Classification Search** D8/82-87,
D8/107, 303; D21/777, 771; D24/147, 133,
D24/127; D4/129, 138; D32/15, 17, 24,
D32/25, 38, 39; 81/177.1-177.4, 436-440,
81/489, 117.1, 480; 16/110.1

See application file for complete search history.

(56) **References Cited**

U.S. PATENT DOCUMENTS

D382,188 S *	8/1997	Lin	D8/85
D414,095 S *	9/1999	Hoepfl et al.	D8/83
D421,888 S *	3/2000	Thompson et al.	D8/85
D422,870 S *	4/2000	Chen	D8/83
D482,259 S *	11/2003	Chen	D8/107
D490,680 S *	6/2004	Levine et al.	D8/83
D517,889 S *	3/2006	Hsieh	D8/83
D528,398 S *	9/2006	Meyer et al.	D8/107
D528,897 S *	9/2006	Wang	D8/107
D529,365 S *	10/2006	Rudder et al.	D8/107
2004/0007103 A1 *	1/2004	Hsien	81/489
2006/0053985 A1 *	3/2006	Chen	81/489

* cited by examiner

Primary Examiner—Cathron C. Brooks

Assistant Examiner—Barbara Fox

(74) *Attorney, Agent, or Firm*—Alston & Bird LLP

(57) **CLAIM**

The ornamental design for handle, as shown and described.

DESCRIPTION

FIG. 1 is a perspective view of handle showing an embodiment of my new design;

FIG. 2 is a left side elevation view thereof, the right side elevation view thereof being a mirror image;

FIG. 3 is a top plan thereof, the bottom plan view thereof being a mirror image;

FIG. 4 is a front elevation view thereof;

FIG. 5 is a rear elevation view thereof;

FIG. 6 is a perspective view of handle showing another embodiment of my new design;

FIG. 7 is a left side elevation view thereof, the right side elevation view thereof being a mirror image;

FIG. 8 is a top plan thereof, the bottom plan view thereof being a mirror image;

FIG. 9 is a front elevation view thereof;

FIG. 10 is a rear elevation view thereof;

FIG. 11 is a perspective view of handle showing yet another embodiment of my new design;

FIG. 12 is a left side elevation view thereof, the right side elevation view thereof being a mirror image;

FIG. 13 is a top plan thereof, the bottom plan view thereof being a mirror image;

FIG. 14 is a front elevation view thereof; and,

FIG. 15 is a rear elevation view thereof.

The broken lines shown herein are for illustrative purposes only and form no part of the claimed design.

1 Claim, 12 Drawing Sheets

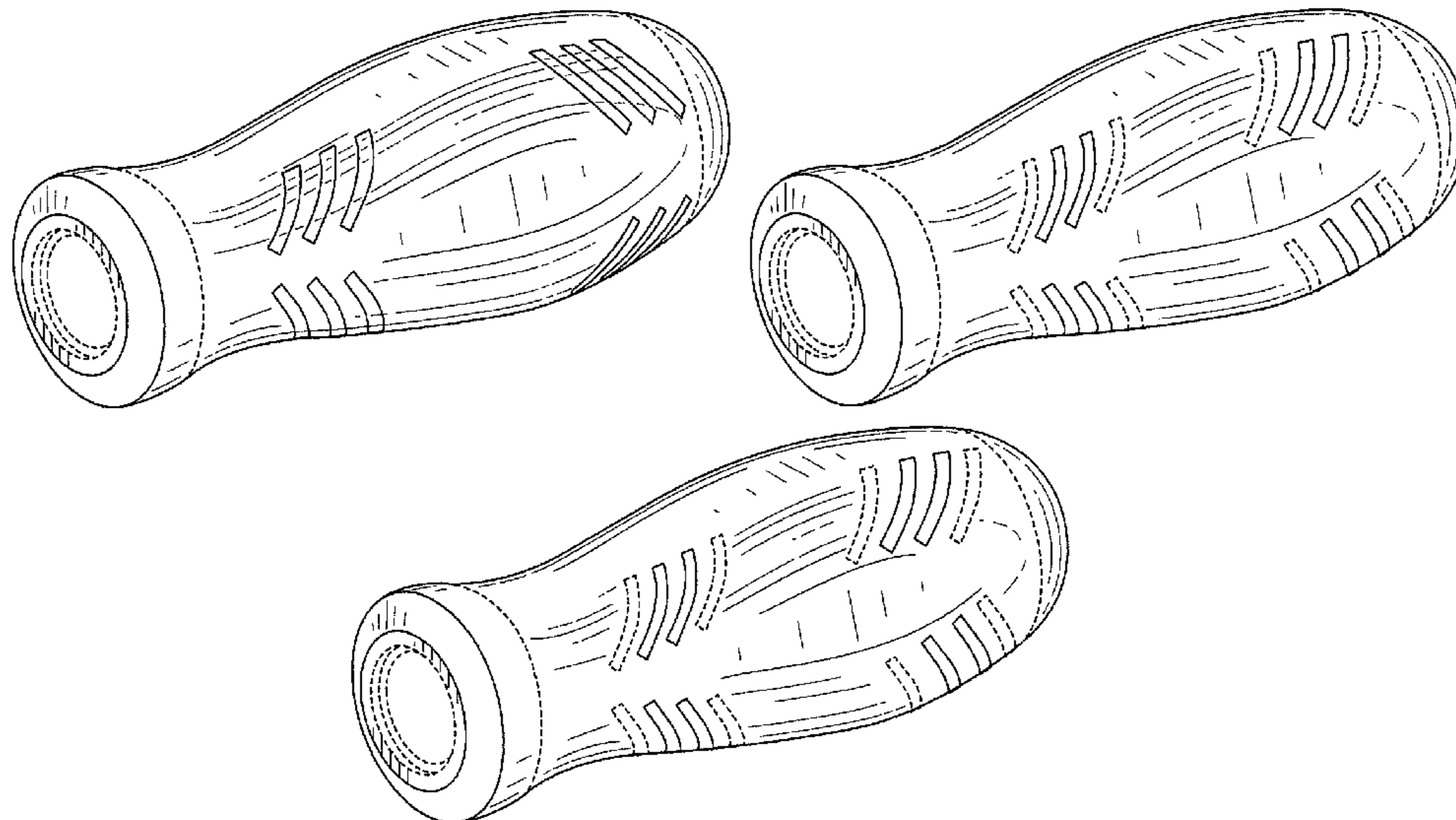

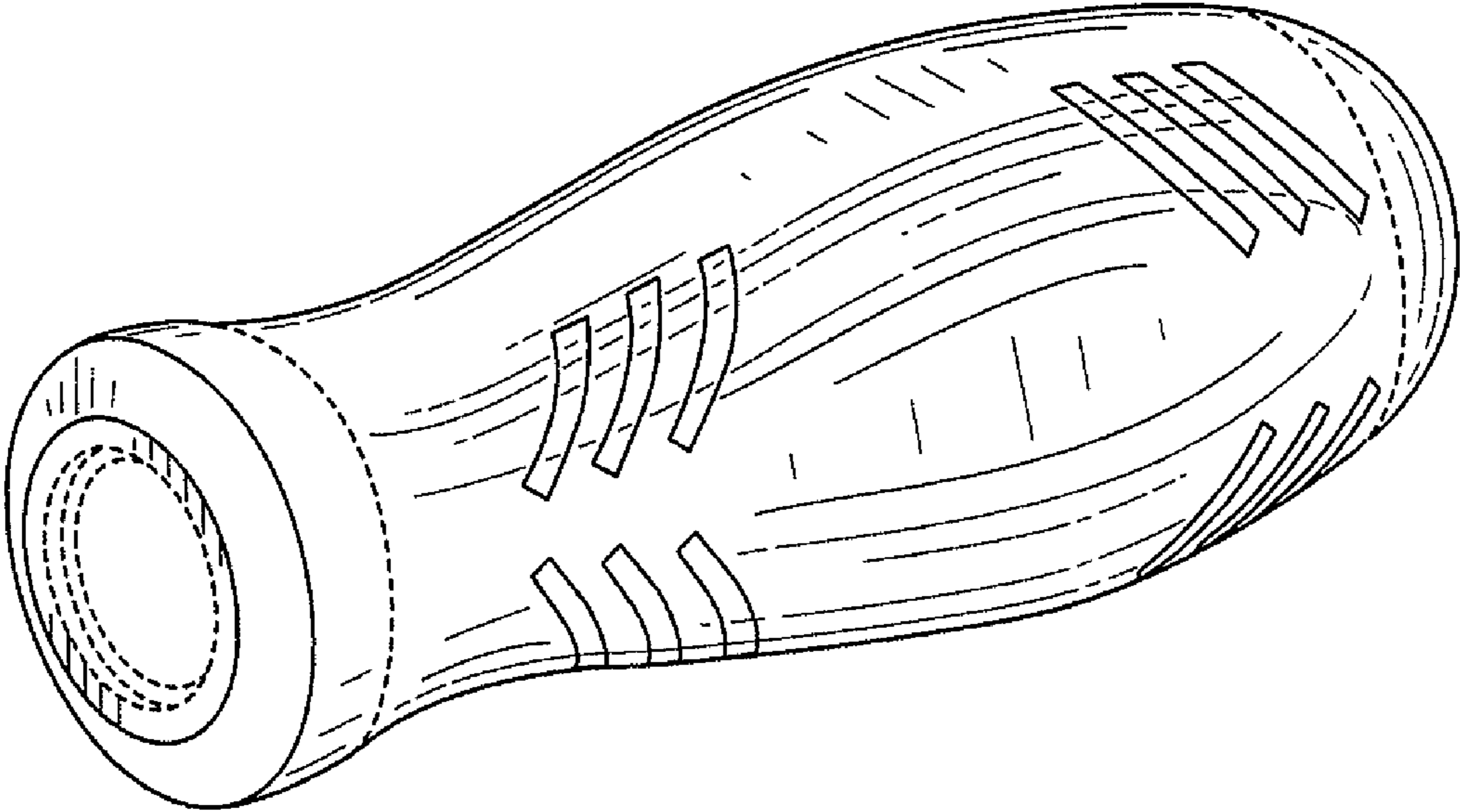

FIG. 1

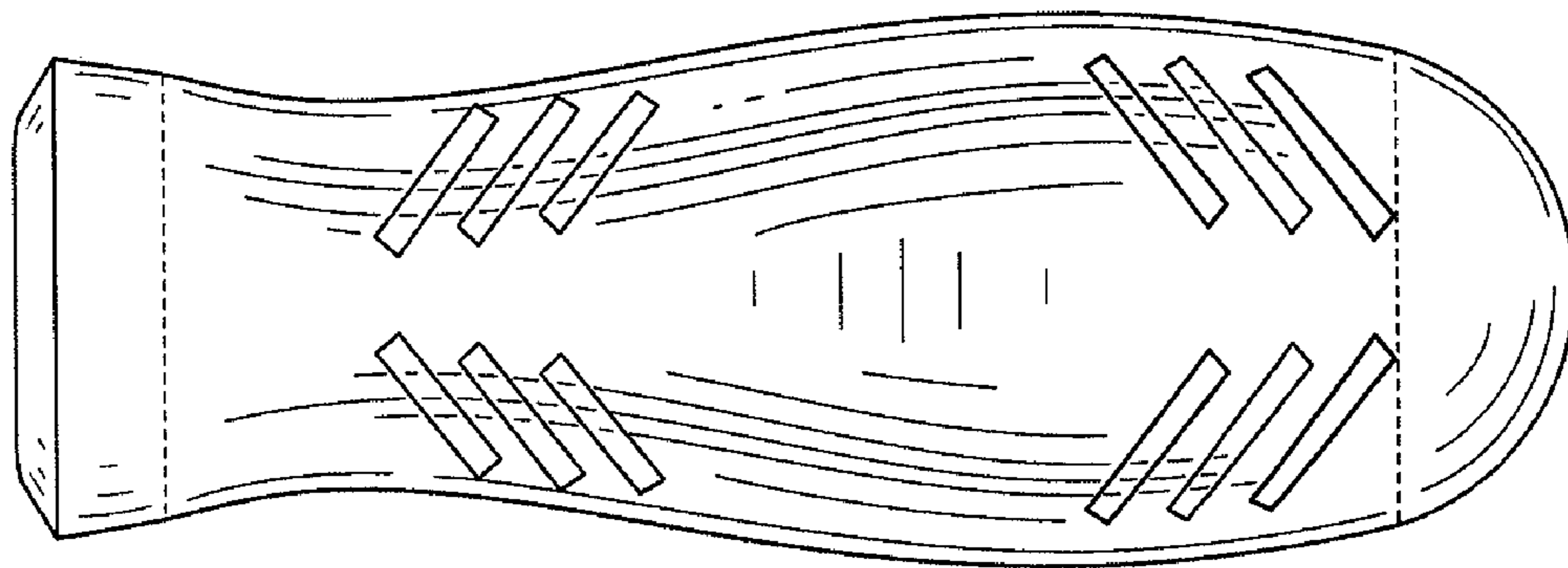

FIG. 2

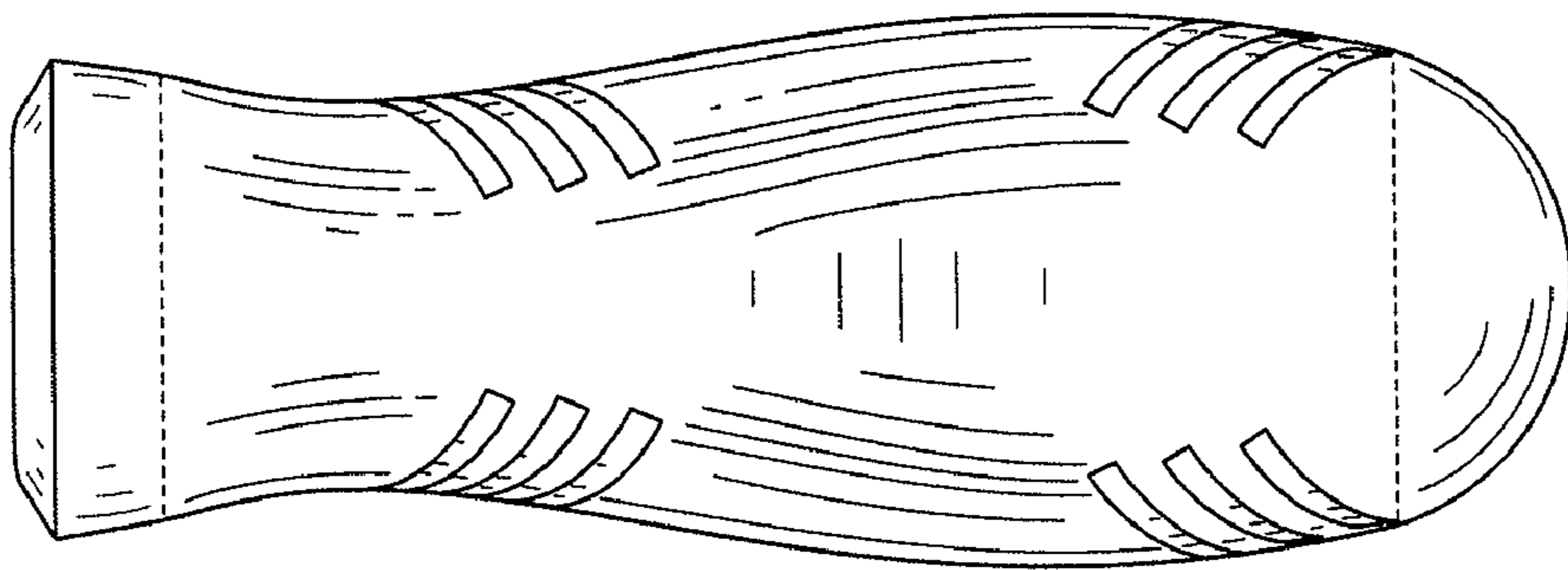

FIG. 3

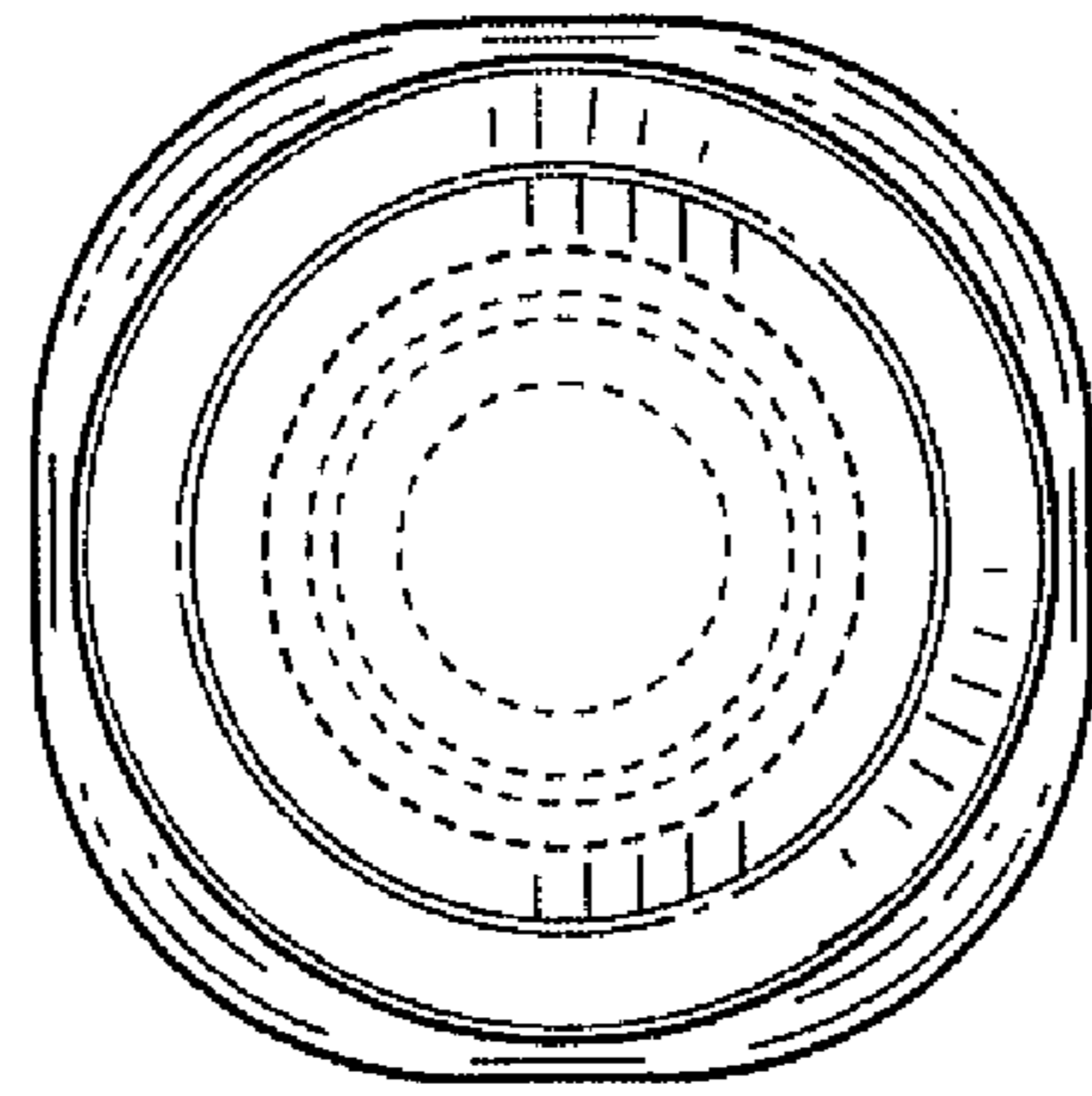

FIG. 4

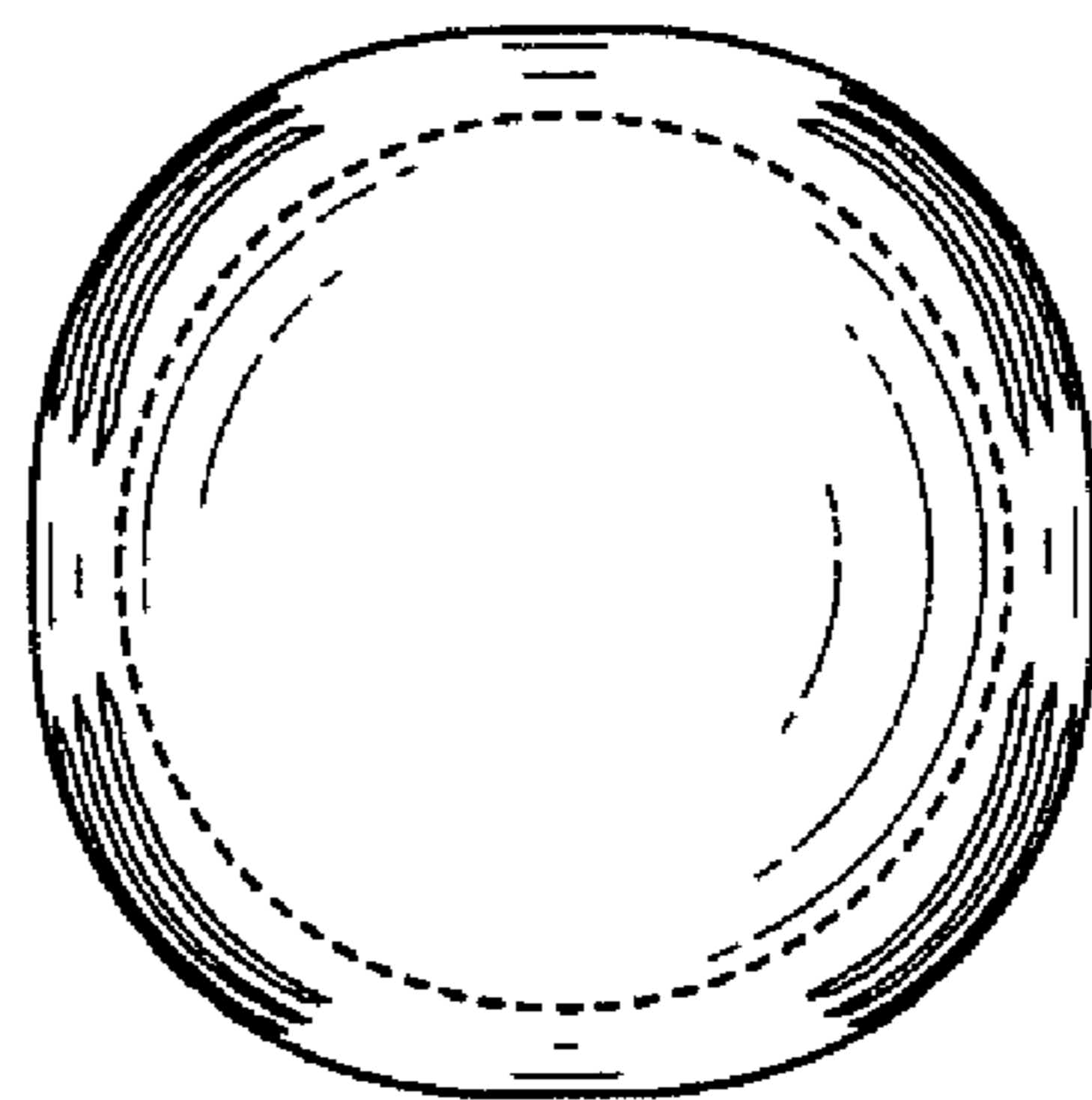

FIG. 5

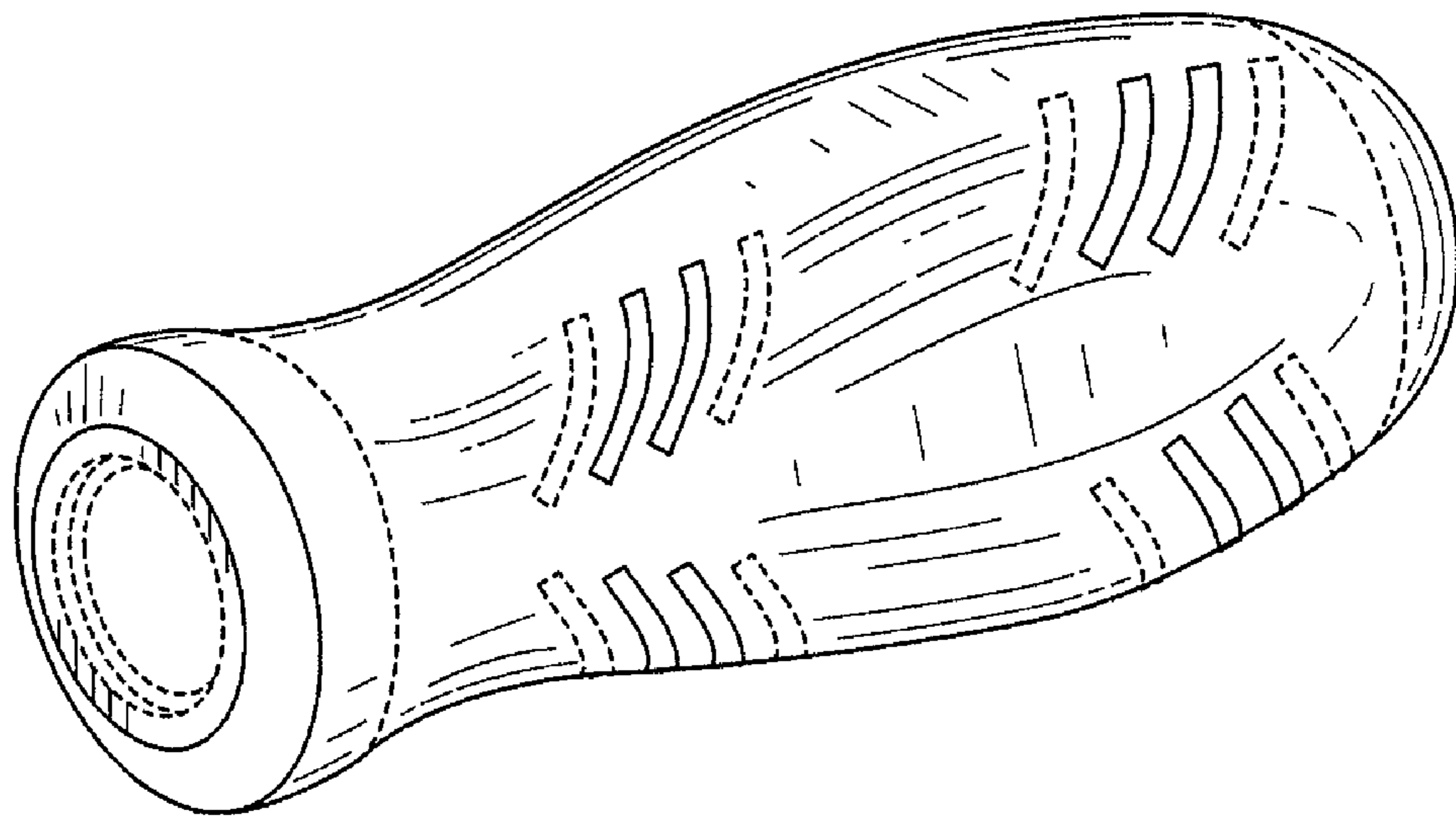

FIG. 6

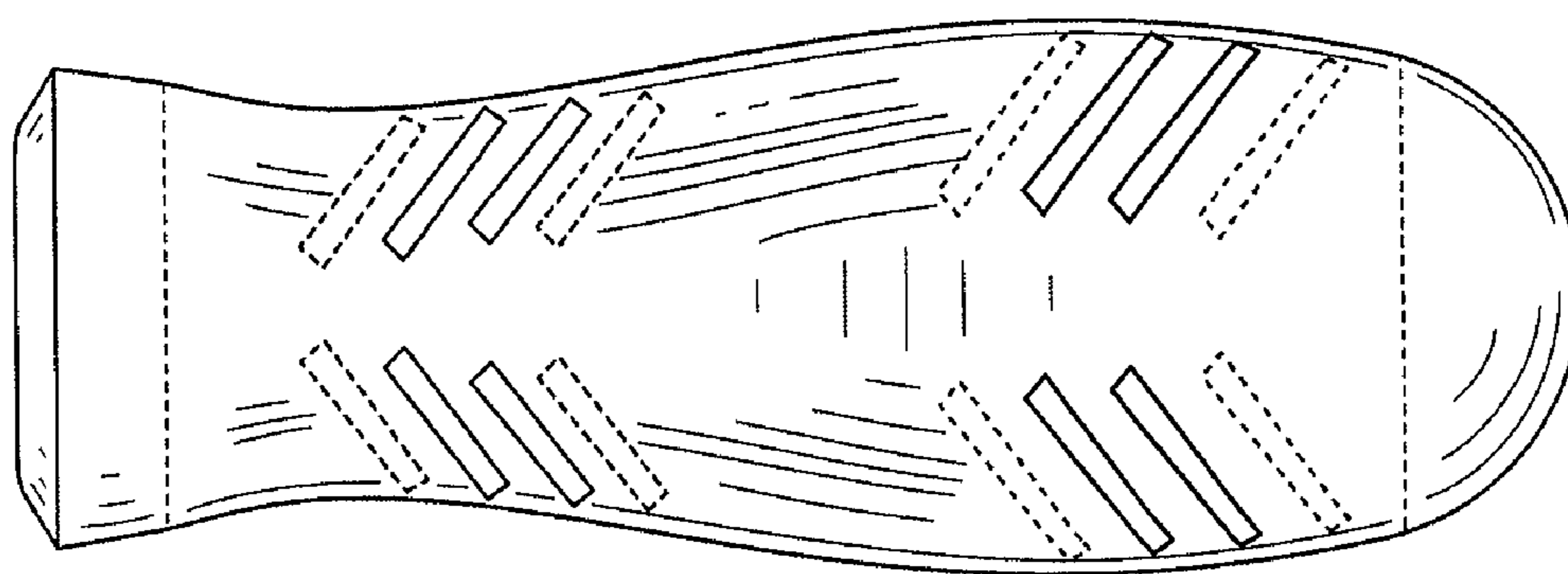

FIG. 7

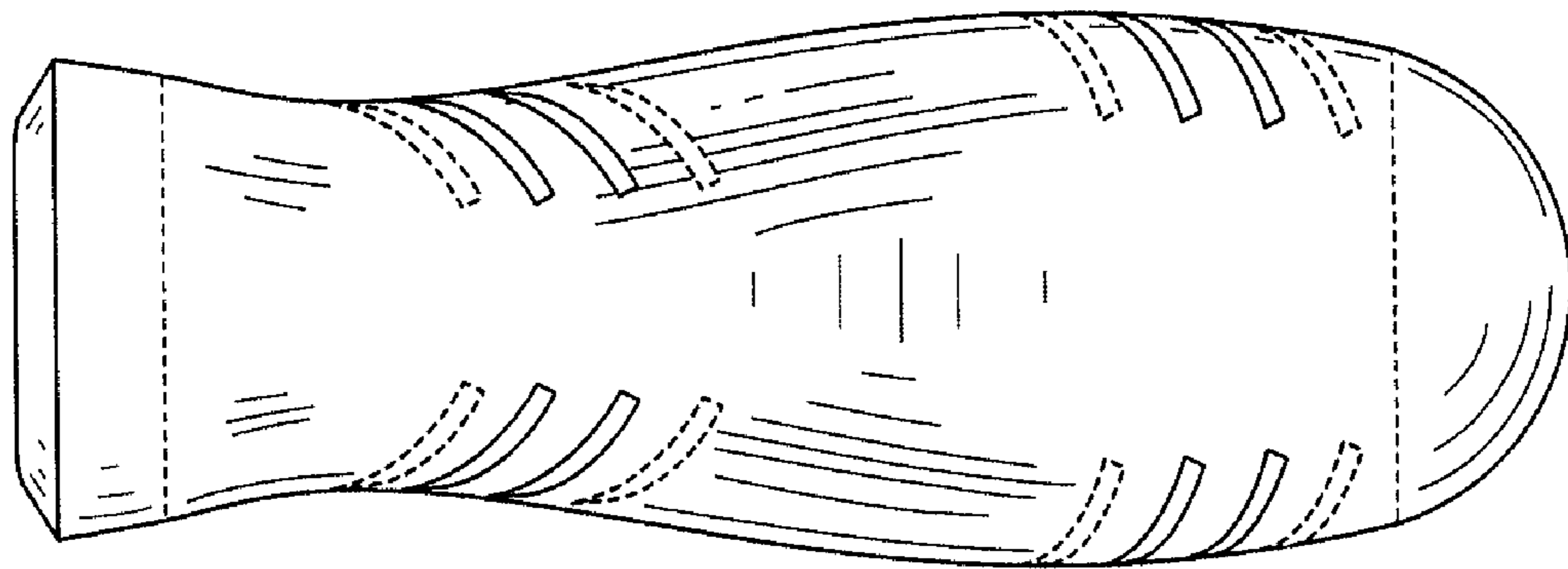

FIG. 8

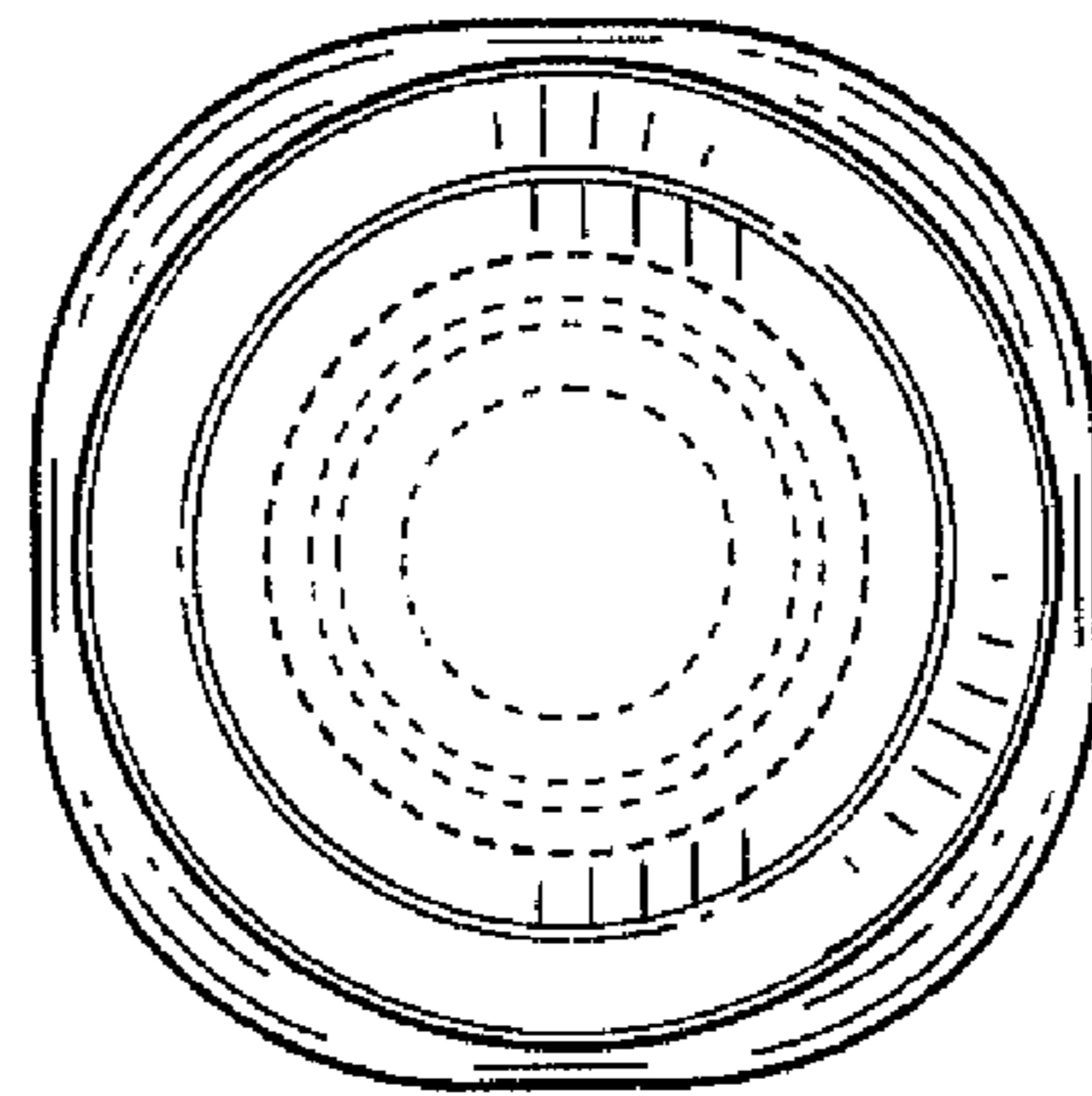

FIG. 9

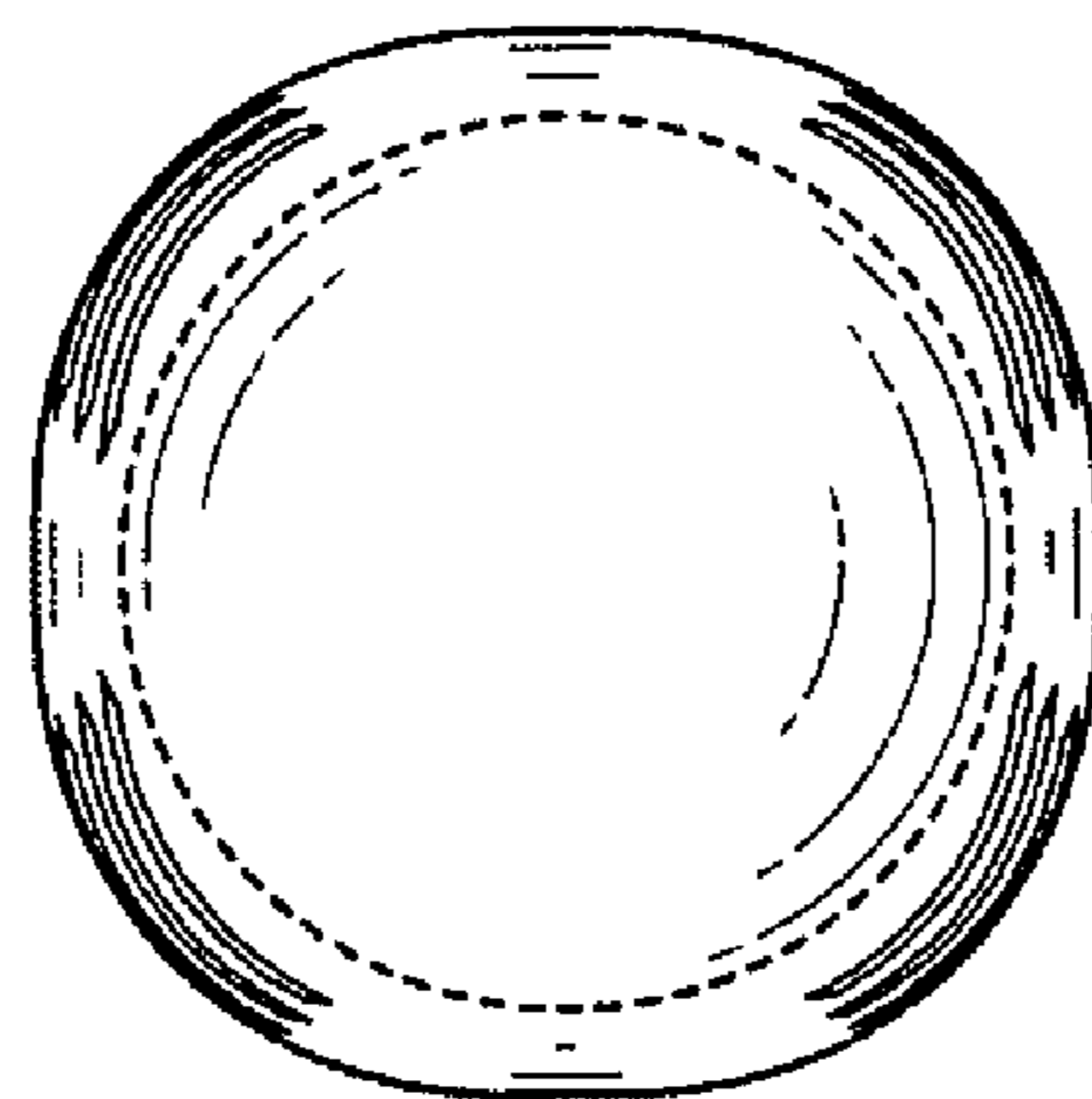

FIG. 10

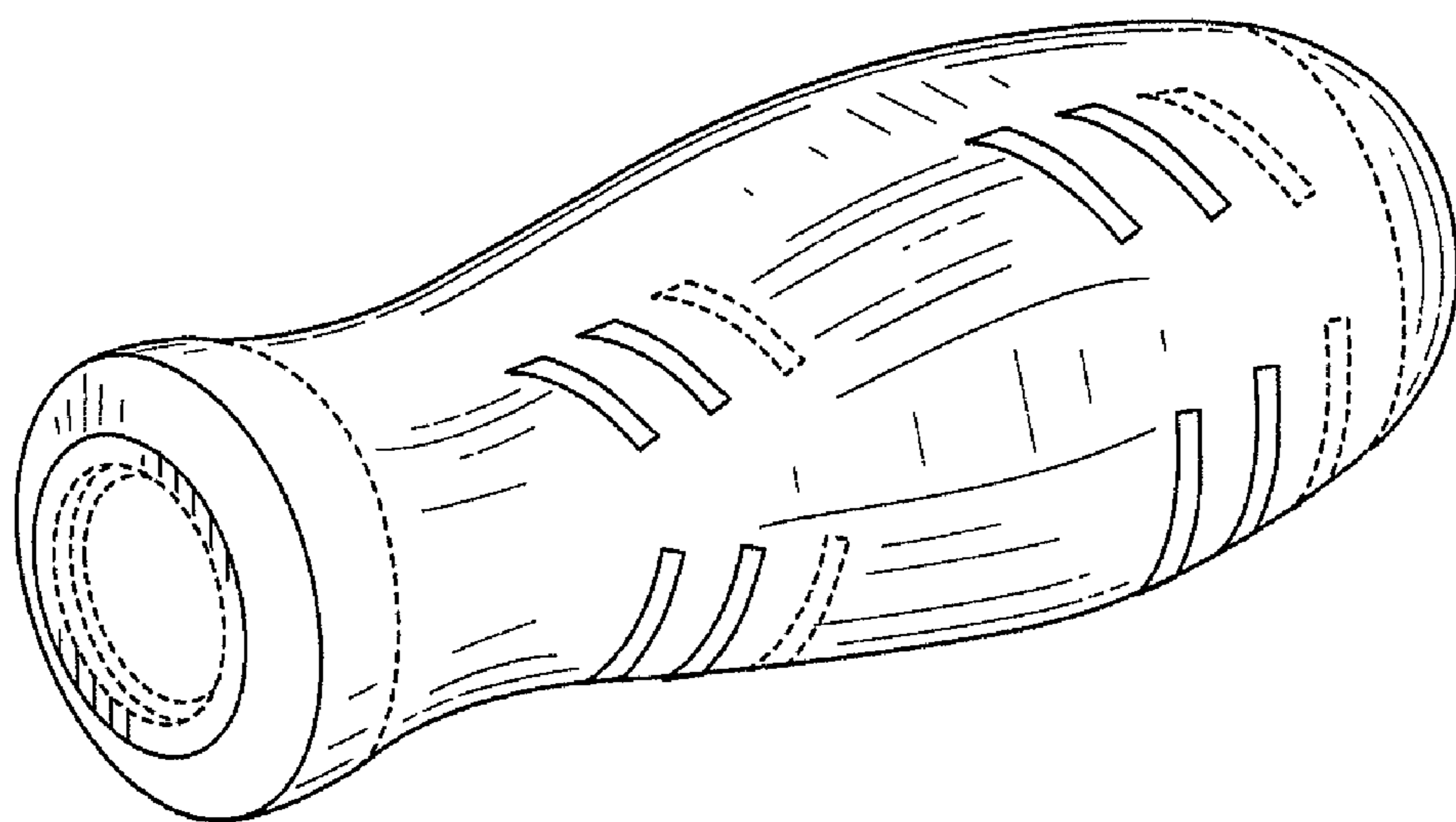

FIG. 11

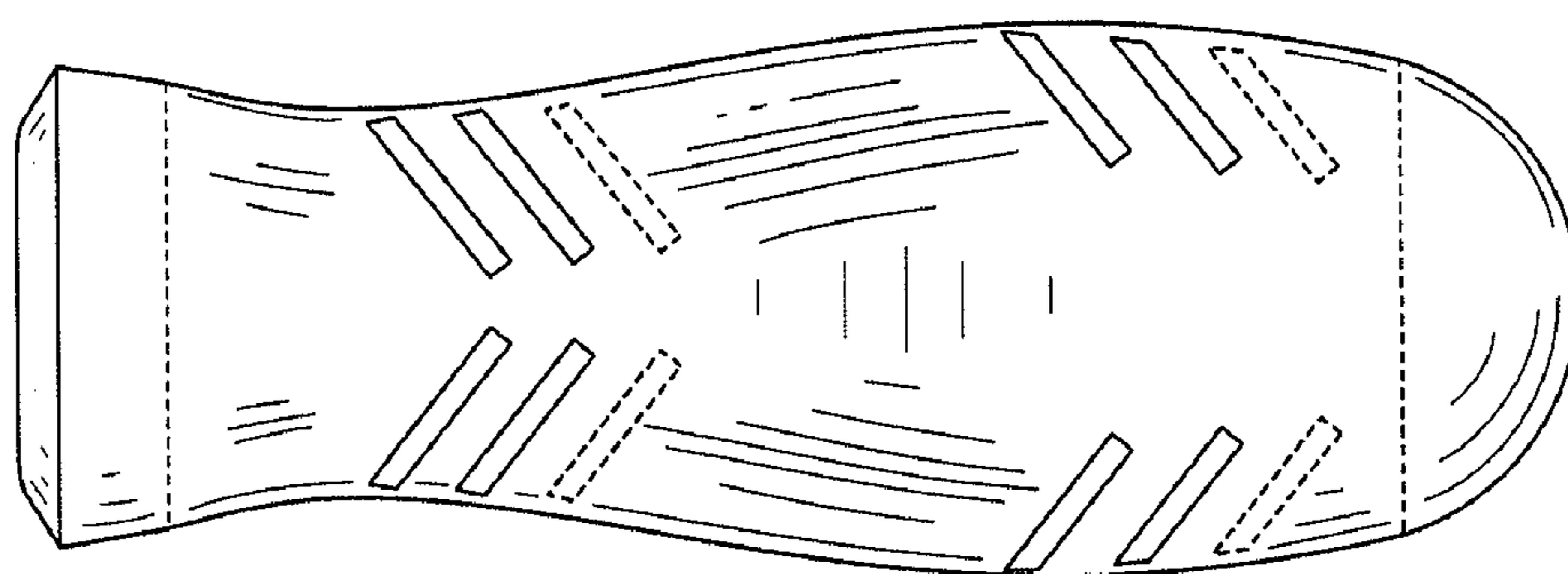

FIG. 12

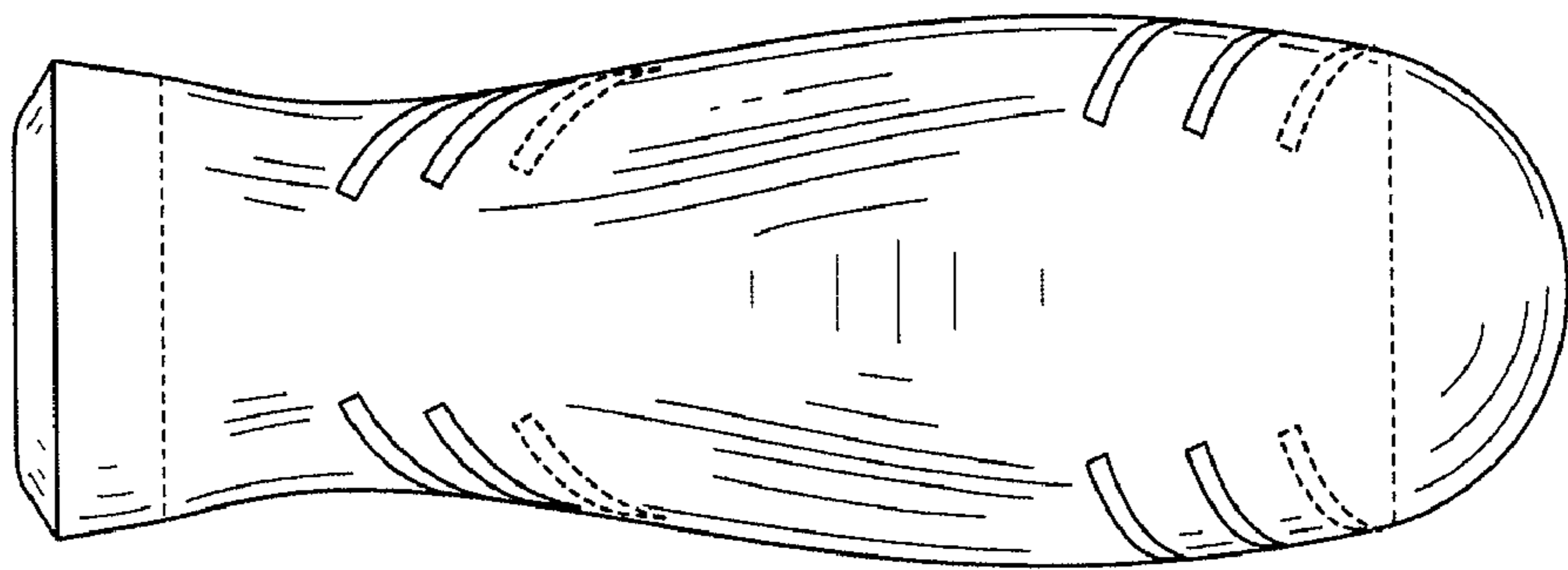

FIG. 13

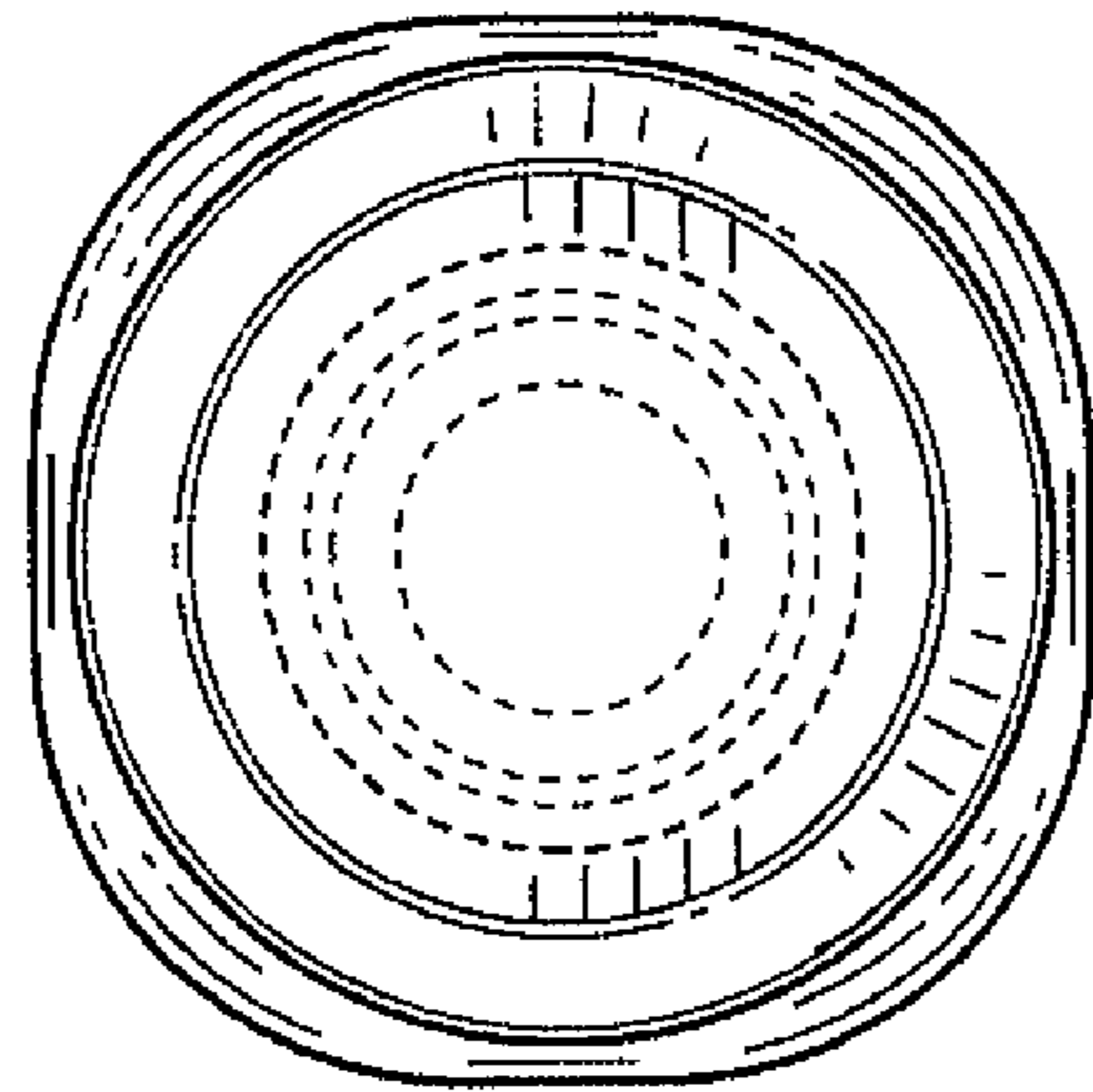

FIG. 14

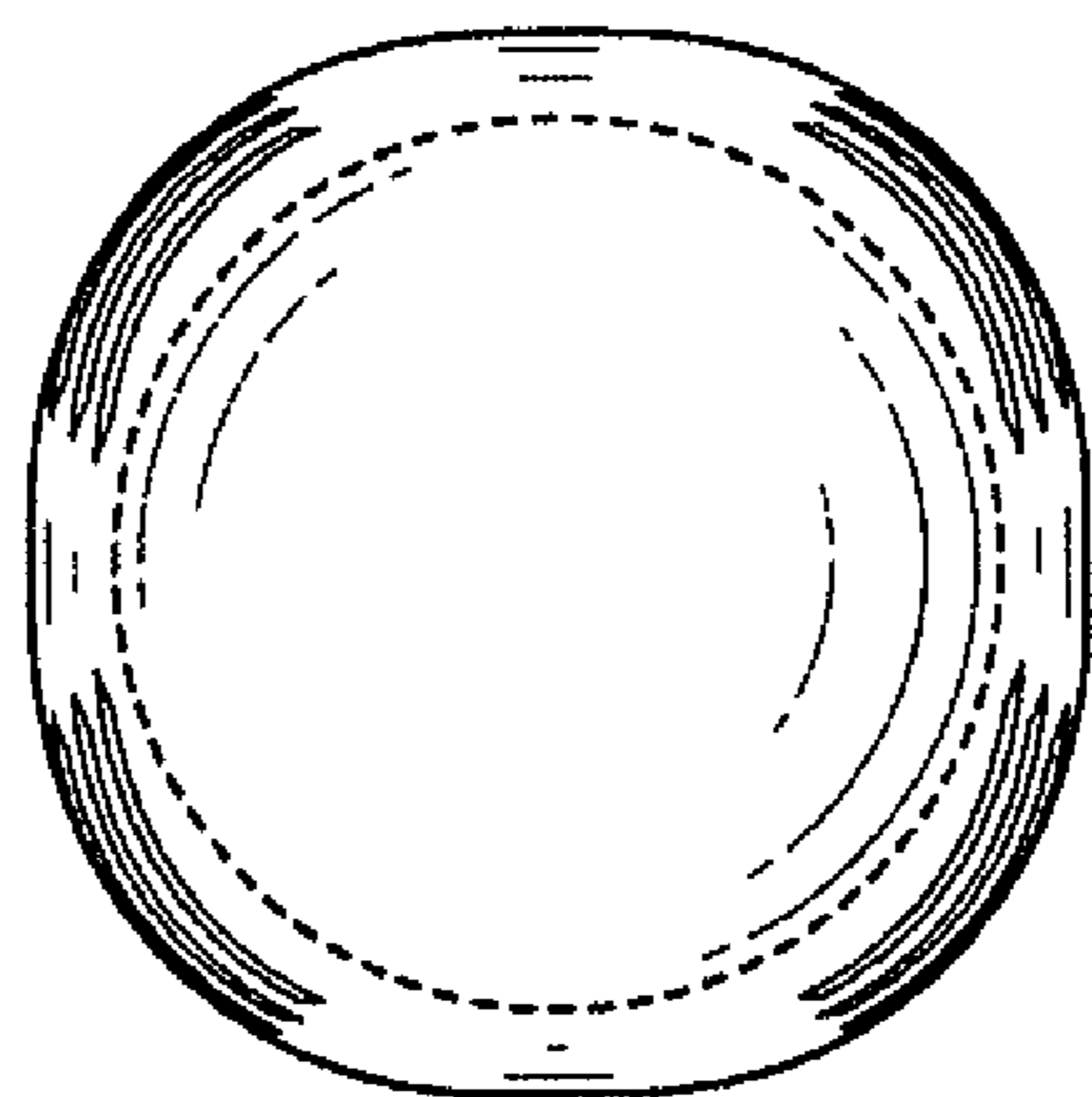

FIG. 15