



US00D550047S

(12) **United States Design Patent** (10) **Patent No.:** **US D550,047 S**  
**Risch et al.** (45) **Date of Patent:** **\*\* Sep. 4, 2007**

(54) **FOOD SERVING UTENSIL**  
(75) Inventors: **Thomas M. Risch**, Weston, CT (US);  
**Bryan Bourgeois**, Underhill, VT (US)  
(73) Assignee: **Liquid Motion, Inc.**, Bethel, CT (US)  
(\*\*) Term: **14 Years**  
(21) Appl. No.: **29/276,384**  
(22) Filed: **Jan. 24, 2007**

5,105,963 A 4/1992 Scott  
D368,630 S \* 4/1996 Geise ..... D7/686  
D369,451 S \* 5/1996 Gornet et al. .... D1/111  
5,895,018 A 4/1999 Rielo  
6,726,263 B2 4/2004 Wang et al.  
6,742,821 B2 6/2004 Kleinpell  
D509,413 S \* 9/2005 Marsden et al. .... D7/686  
2005/0183579 A1 8/2005 Bowers  
2005/0236853 A1 10/2005 Demetroulakos et al.

**FOREIGN PATENT DOCUMENTS**

WO WO 00/30508 6/2000

\* cited by examiner

*Primary Examiner*—Terry A. Wallace  
(74) *Attorney, Agent, or Firm*—Gordon & Jacobson, PC

**Related U.S. Application Data**

(63) Continuation of application No. 29/275,172, filed on Dec. 15, 2006.

(51) **LOC (8) Cl.** ..... **07-06**  
(52) **U.S. Cl.** ..... **D7/685; D1/104**  
(58) **Field of Classification Search** ..... D7/683–686,  
D7/689, 625, 566, 567, 571, 573, 578; D1/104,  
D1/111; 294/1.1, 1.3, 16, 25, 99.1, 99.2,  
294/118, 119; 452/103, 185, 196  
See application file for complete search history.

(57) **CLAIM**

The ornamental design for a food serving utensil, as shown and described.

**DESCRIPTION**

FIG. 1 is a top perspective view of a food serving utensil in a locked position;  
FIG. 2 is a top view of a food serving utensil in a locked position;  
FIG. 3 is a front view of a food serving utensil in a locked position;  
FIG. 4 is a side view of a food serving utensil in a locked position;  
FIG. 5 is a rear view of a food serving utensil in a locked position;  
FIG. 6 is a top perspective view of a food serving utensil in a closed position; and,  
FIG. 7 is perspective view of a food serving utensil in an open position.  
The broken lines which define the bounds of the claimed design form no part thereof.

(56) **References Cited**  
U.S. PATENT DOCUMENTS

567,087 A 9/1896 Fitzgerald et al.  
941,798 A 11/1909 Moore  
1,333,941 A 3/1920 Silver  
D85,796 S 12/1931 Wells  
D117,712 S \* 11/1939 Guild ..... D7/567  
D119,040 S \* 2/1940 Hoffman ..... D1/111  
2,244,072 A 6/1941 Ledbetter  
D141,461 S 6/1945 Wyszynski  
2,444,116 A 6/1948 Rossi  
2,518,873 A \* 8/1950 Eisenberg et al. .... 15/143.1  
2,881,022 A 4/1959 Brust  
3,181,198 A 5/1965 Stelzen  
3,975,043 A 8/1976 Miles  
4,148,510 A 4/1979 Brack et al.  
4,183,439 A 1/1980 Bell  
4,586,616 A 5/1986 Cooper et al.  
4,682,803 A 7/1987 Andrews

**1 Claim, 5 Drawing Sheets**

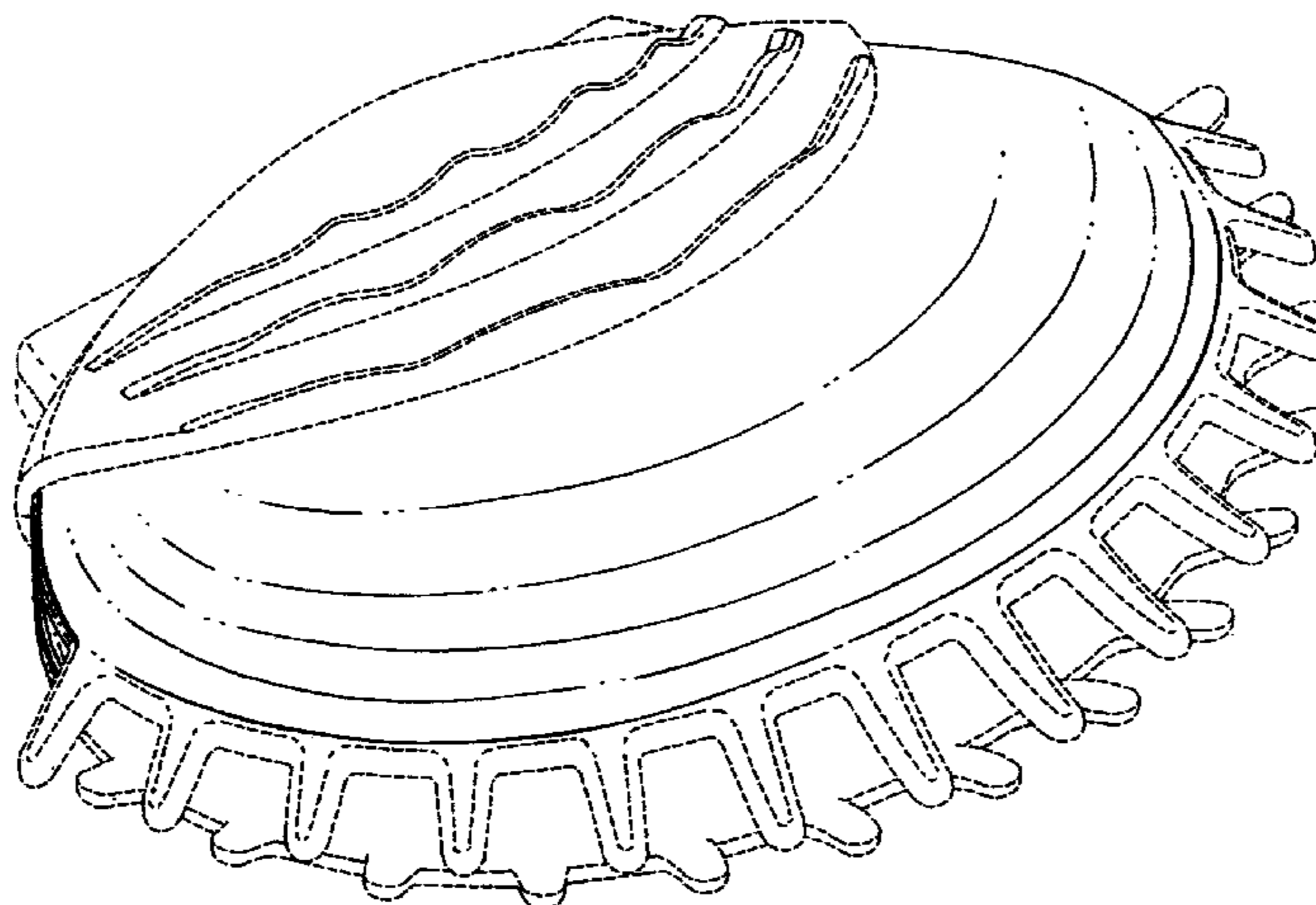

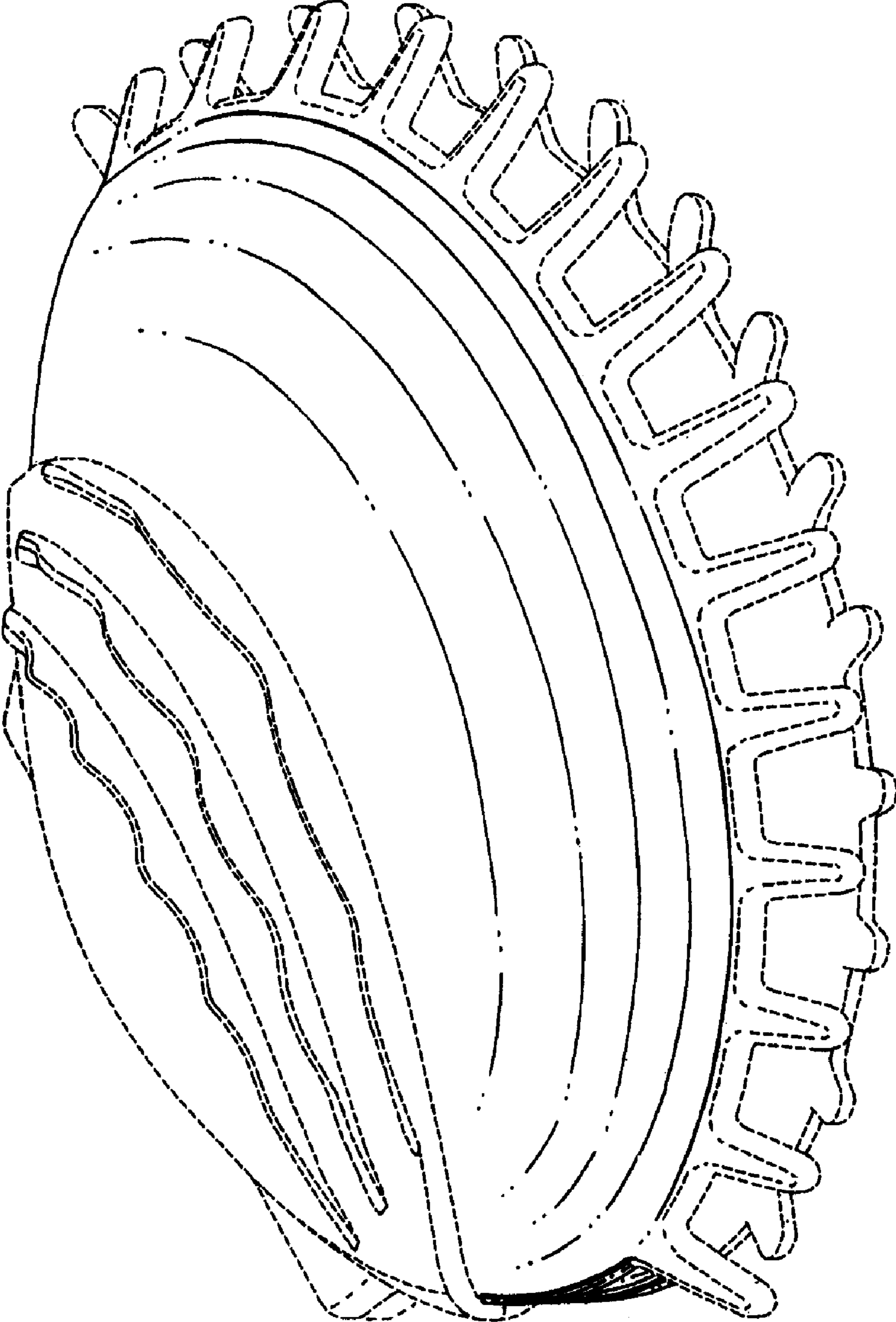

FIG. 1

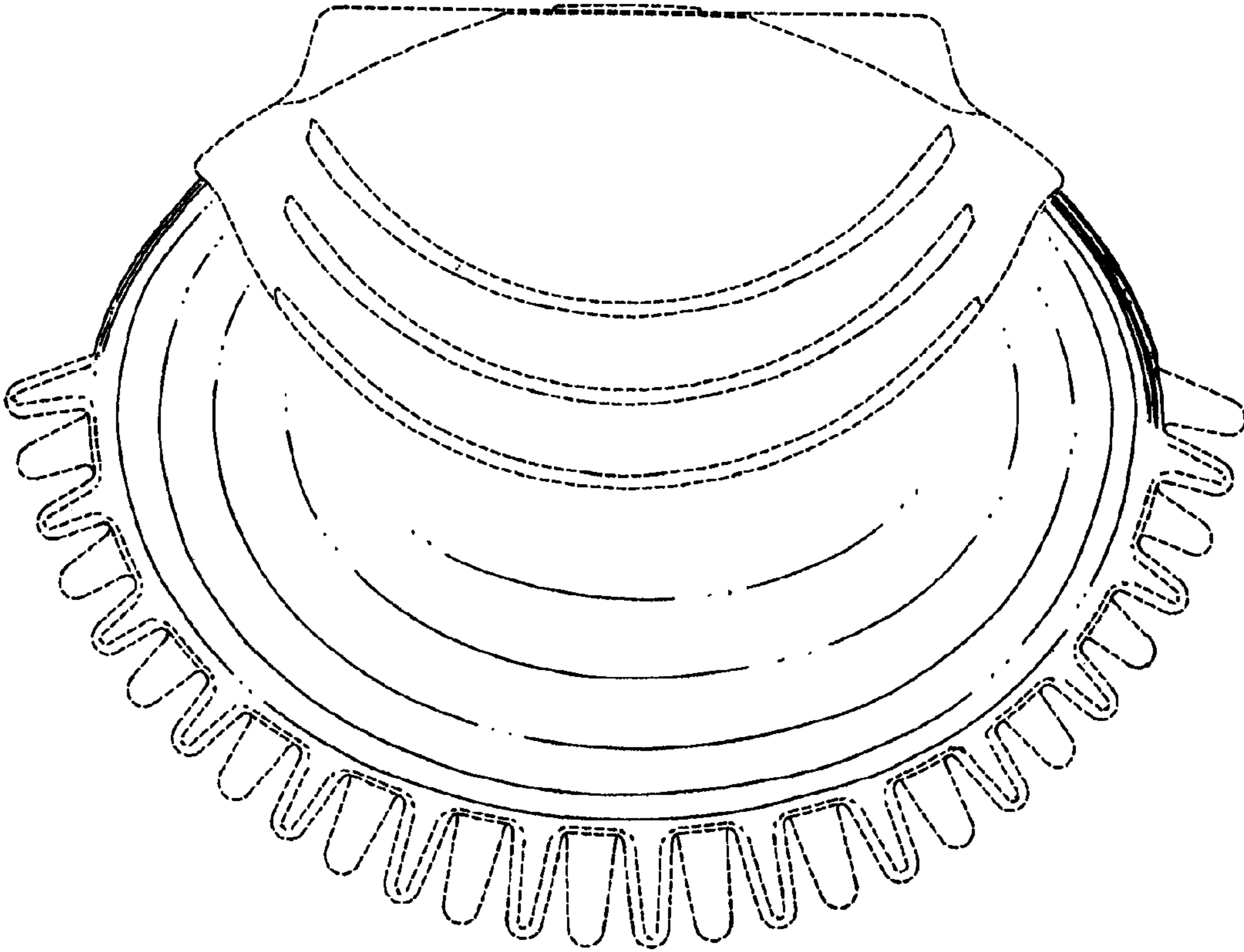

FIG. 2

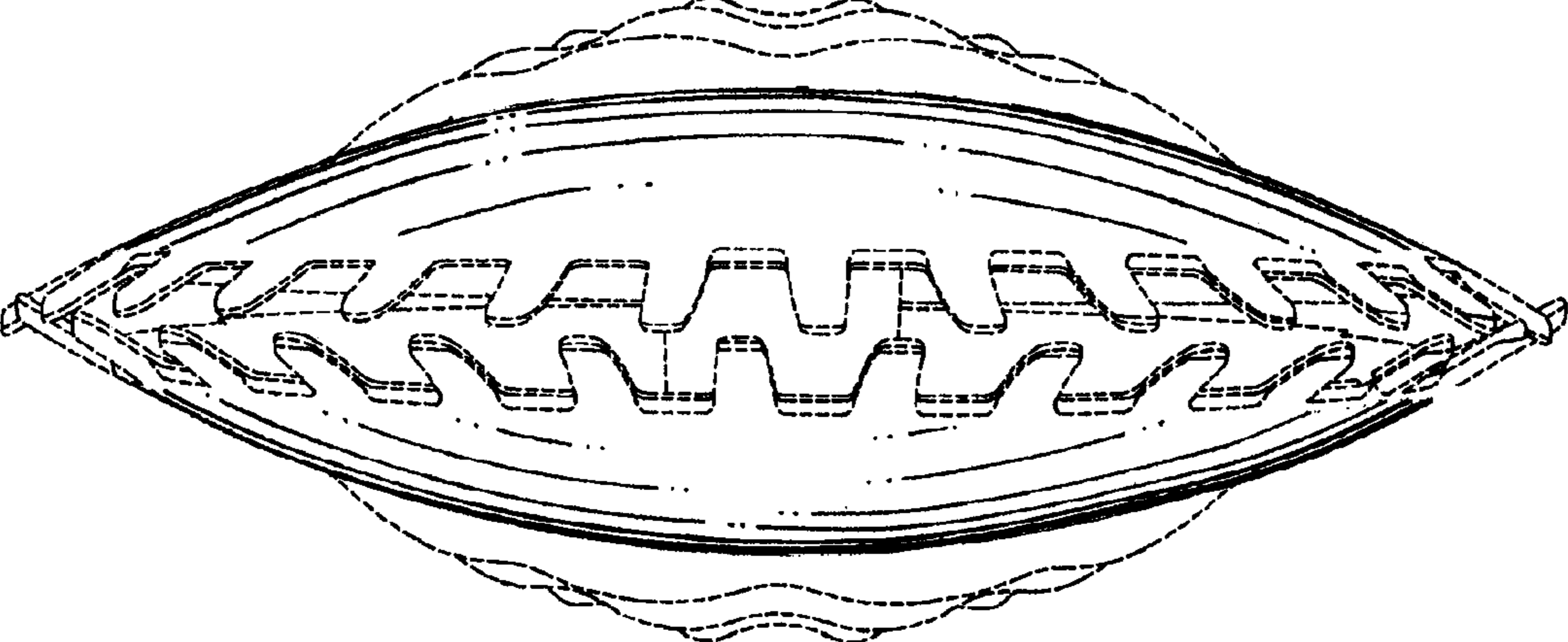

FIG. 3

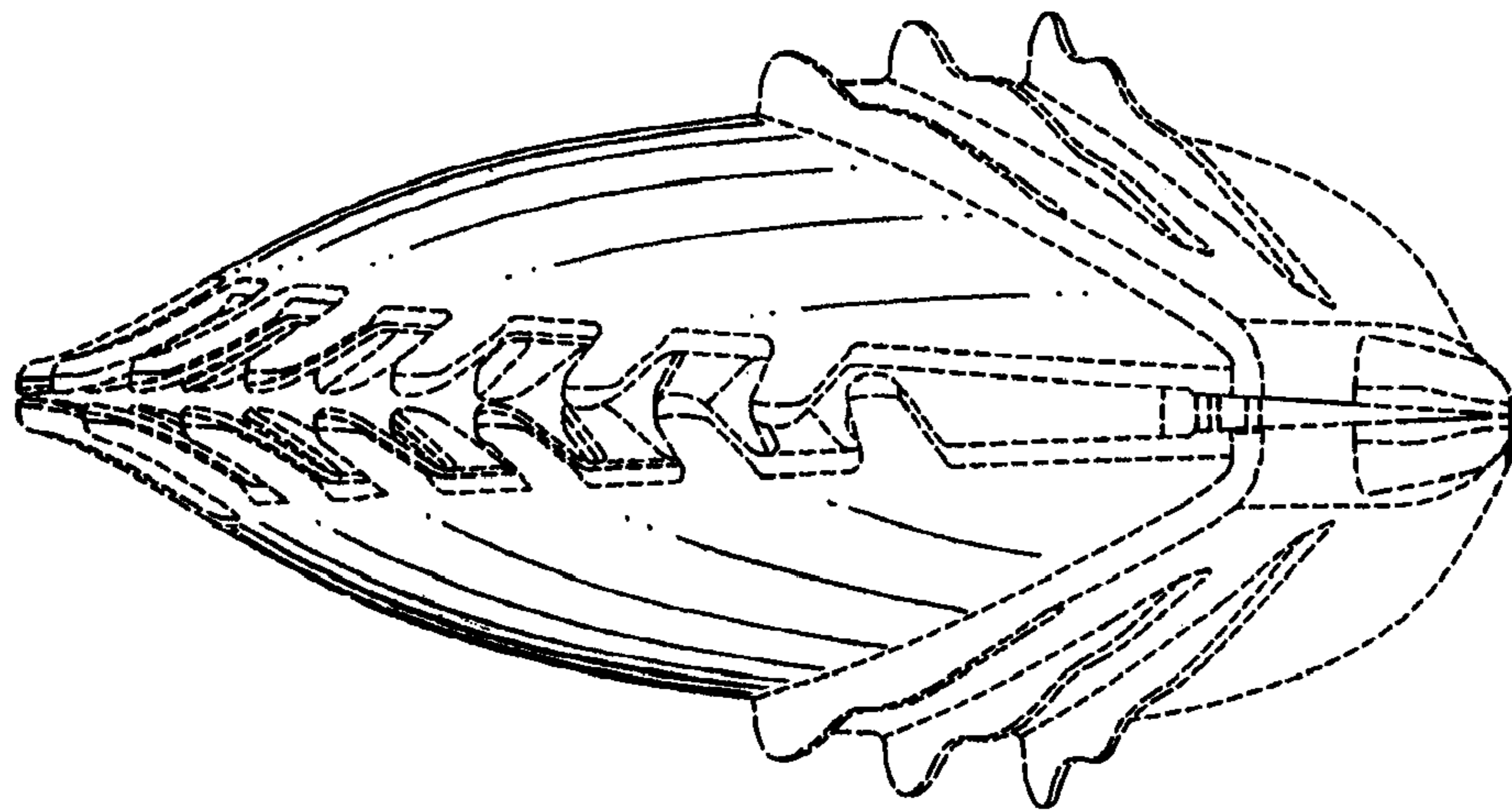

FIG. 4

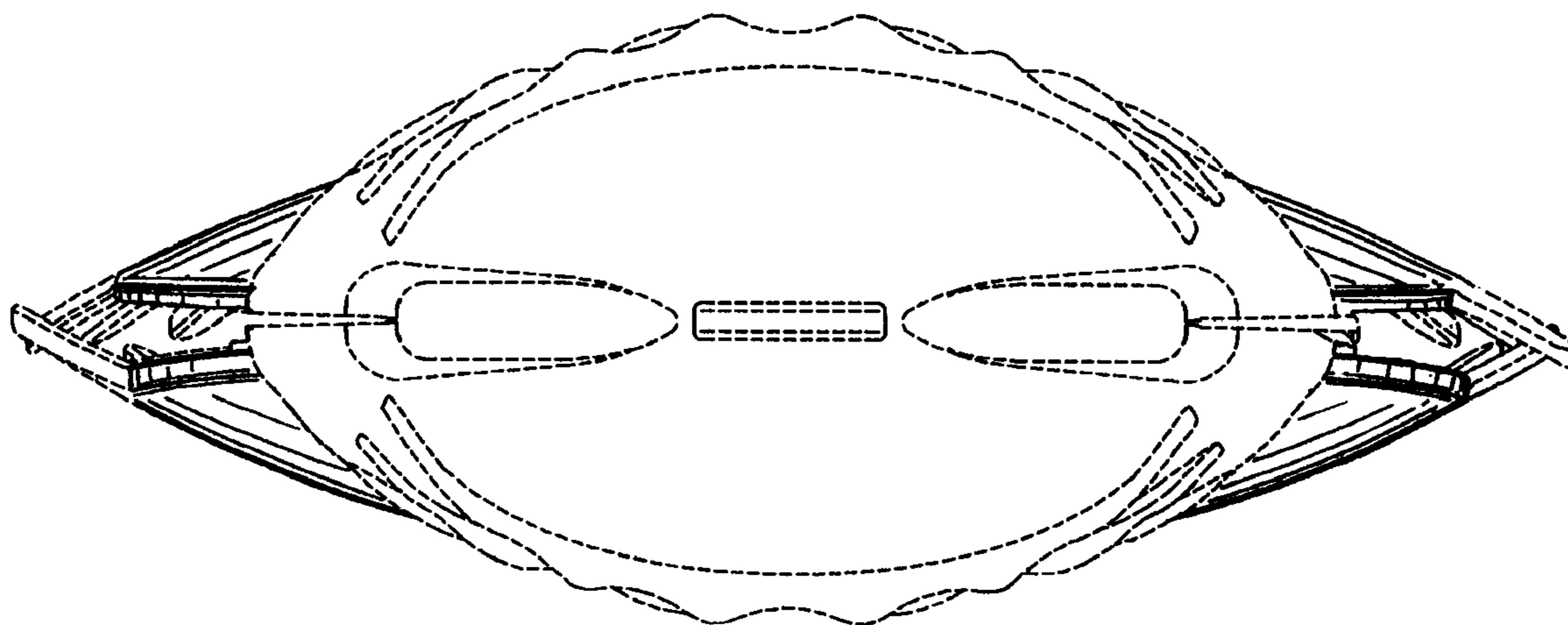

FIG. 5

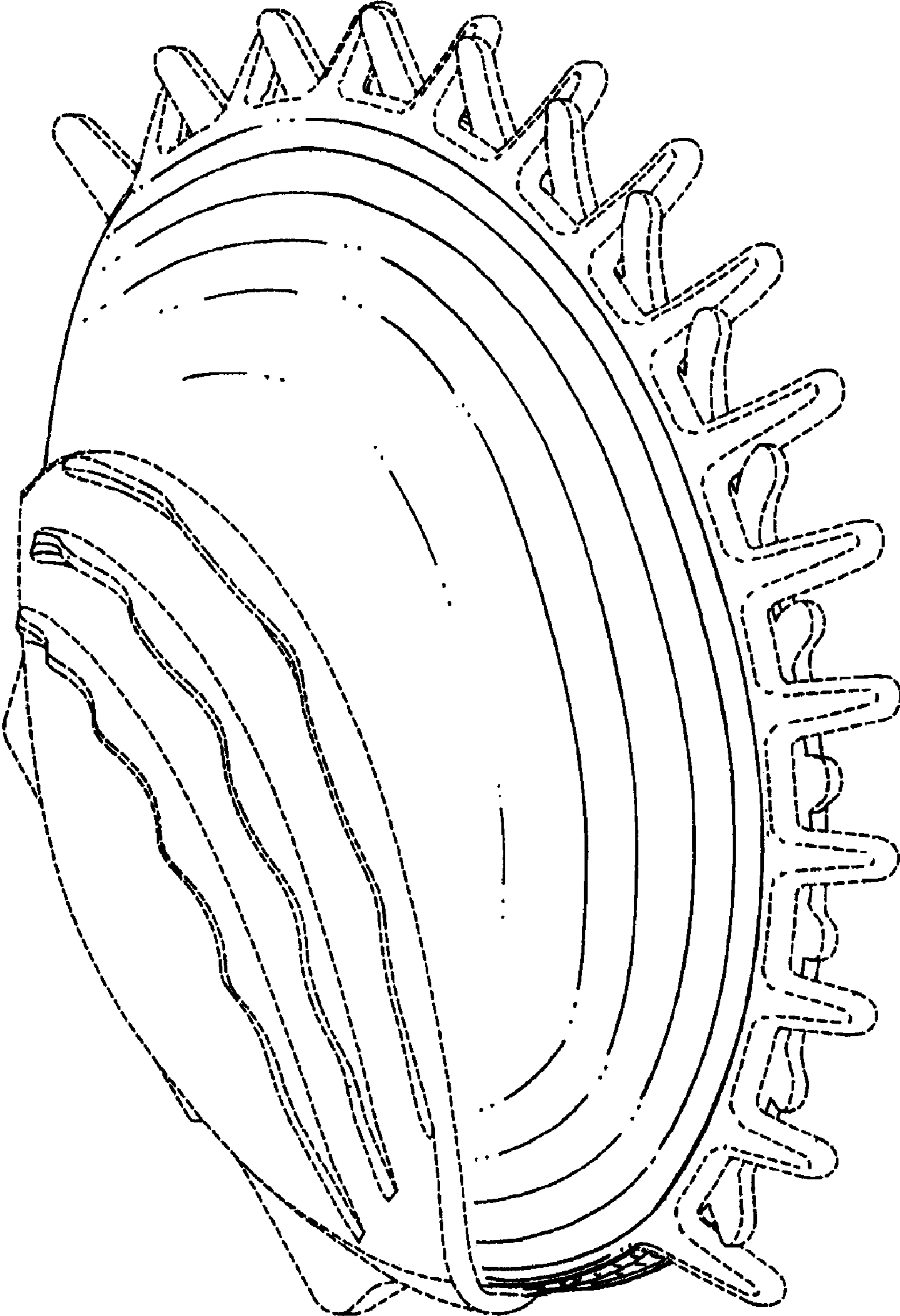

FIG.6

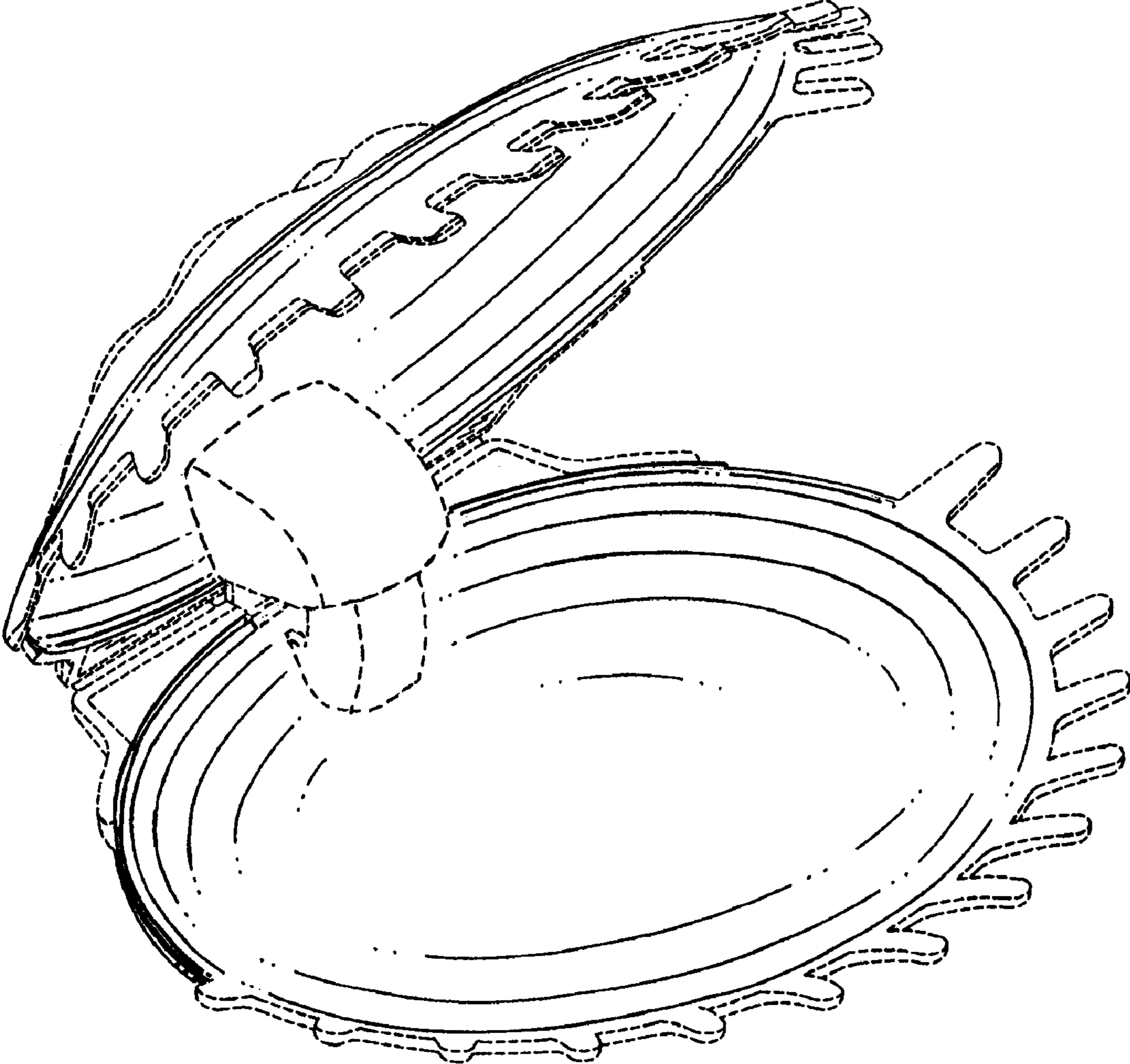

FIG.7