



US00D549958S

(12) **United States Design Patent**
Boyd et al.

(10) **Patent No.:** **US D549,958 S**
(45) **Date of Patent:** **** Sep. 4, 2007**

(54) **HOLSTER FOR ELECTRONIC DEVICES**

(57) **CLAIM**

(75) Inventors: **Michael Boyd**, Boulder, CO (US); **Rick Case**, Boulder, CO (US); **Dennis Balchunas**, Boulder, CO (US)

The ornamental design for a holster for electronic devices, as shown and described.

(73) Assignee: **Nite Ize, Inc.**, Boulder, CO (US)

DESCRIPTION

(**) Term: **14 Years**

FIG. 1 is a perspective view showing the front and a first side of a first preferred embodiment of a holster according to the invention;

(21) Appl. No.: **29/269,449**

FIG. 2 is a perspective view showing the rear and first side of the holster of FIG. 1;

(22) Filed: **Nov. 30, 2006**

FIG. 3 is a front view of the holster of FIG. 1;

(51) **LOC (8) Cl.** **03-01**

FIG. 4 is a rear view of the holster of FIG. 1;

(52) **U.S. Cl.** **D3/218**

FIG. 5 is a side view showing a second side of the holster of FIG. 1;

(58) **Field of Classification Search** D3/218,
D3/219, 215, 228, 226, 230, 303, 232-246;
224/240, 914, 904, 675-677, 242, 647, 667-668;
383/10, 29, 42, 93, 95, 97-98, 104, 109
See application file for complete search history.

FIG. 6 is a side view showing the first side of the holster of FIG. 1;

FIG. 7 is a top view of the holster of FIG. 1;

FIG. 8 is a bottom view of the holster of FIG. 1;

FIG. 9 is a perspective view showing the front and a first side of a second preferred embodiment of a holster according to the invention;

(56) **References Cited**

U.S. PATENT DOCUMENTS

D364,038 S	*	11/1995	Stanchin	D3/230
D500,409 S	*	1/2005	Rivera et al.	D3/228
D508,607 S	*	8/2005	Balchunas et al.	D3/303
D532,199 S	*	11/2006	Balchunas et al.	D3/303
D539,031 S	*	3/2007	Balchunas et al.	D3/226

FIG. 10 is a perspective view showing the rear and first side of the holster of FIG. 9;

FIG. 11 is a front view of the holster of FIG. 9;

FIG. 12 is a rear view of the holster of FIG. 9;

FIG. 13 is a side view showing a second side of the holster of FIG. 9;

FIG. 14 is a side view showing the first side of the holster of FIG. 9;

* cited by examiner

FIG. 15 is a top view of the holster of FIG. 9; and,

FIG. 16 is a bottom view of the holster of FIG. 9.

Primary Examiner—Catherine R. Oliver
(74) *Attorney, Agent, or Firm*—Patton Boggs LLP

1 Claim, 10 Drawing Sheets

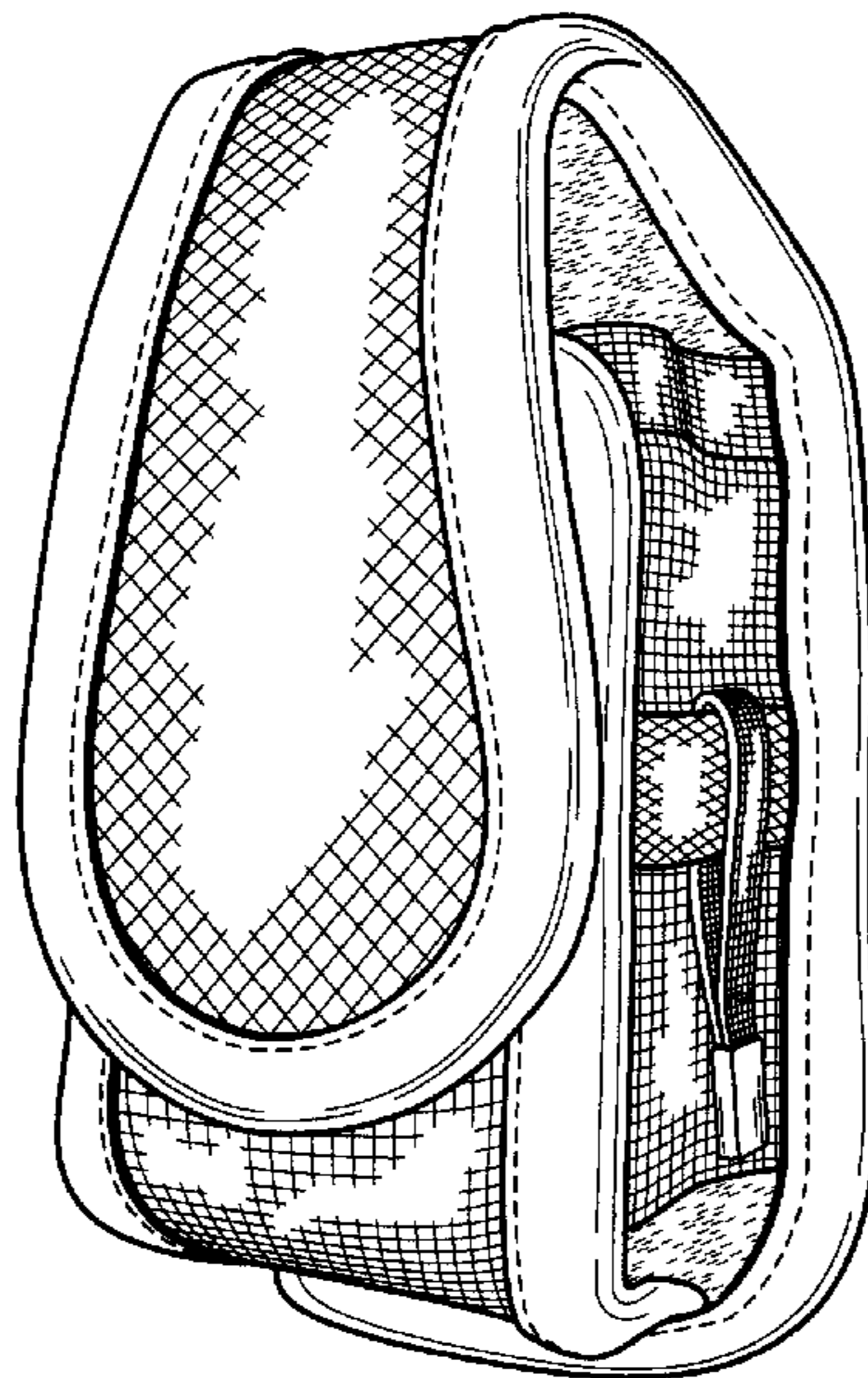

FIG. 1

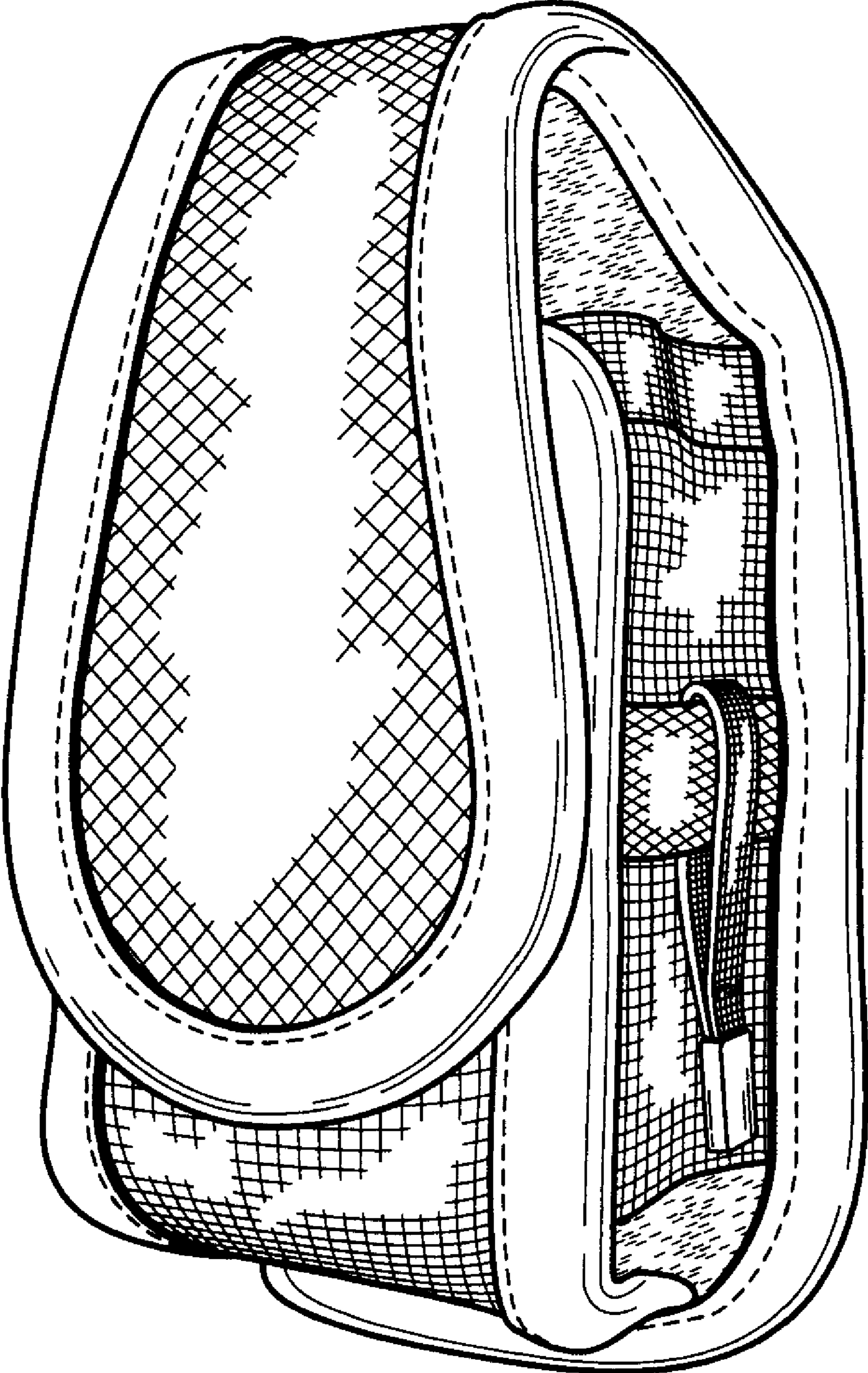
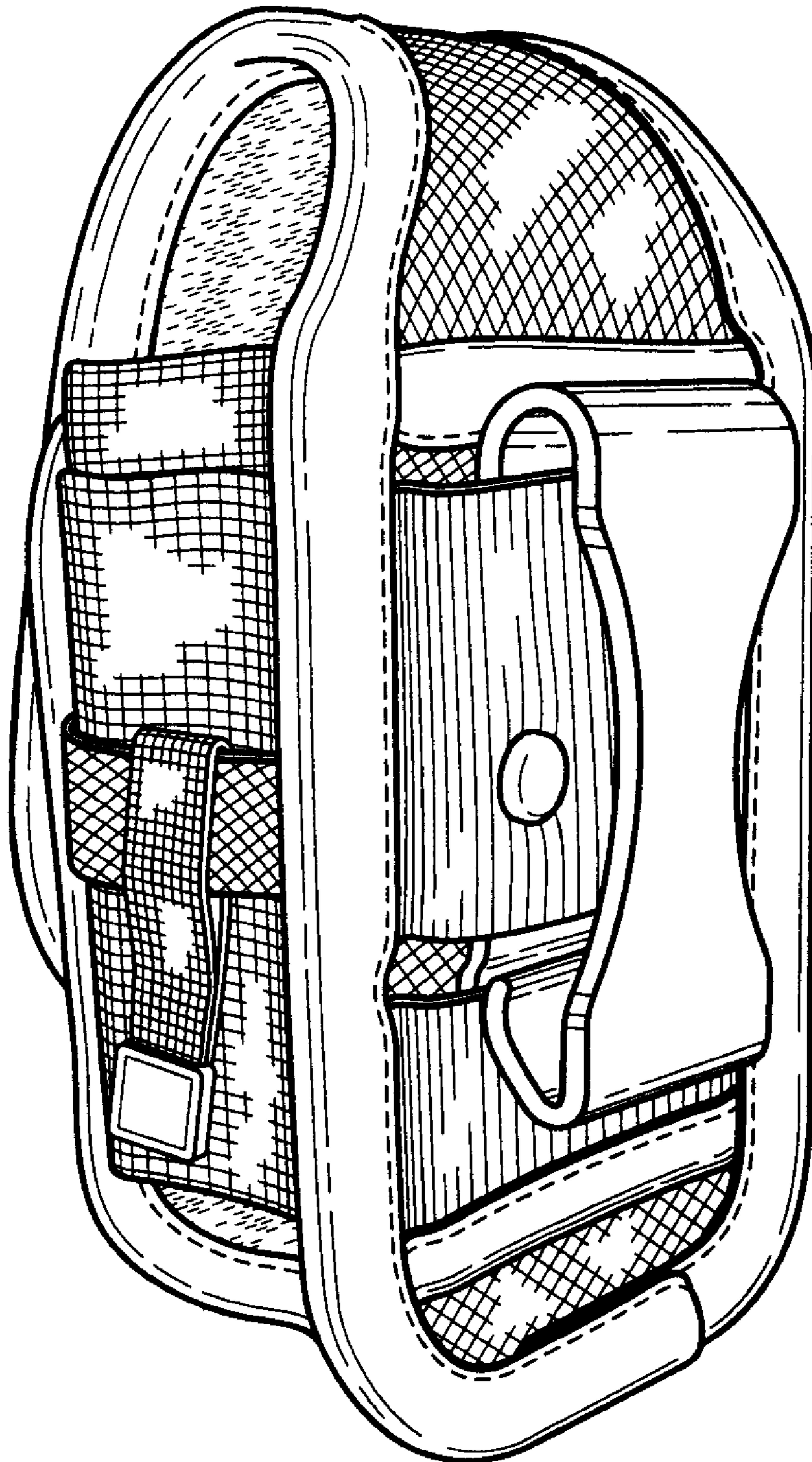

FIG. 2



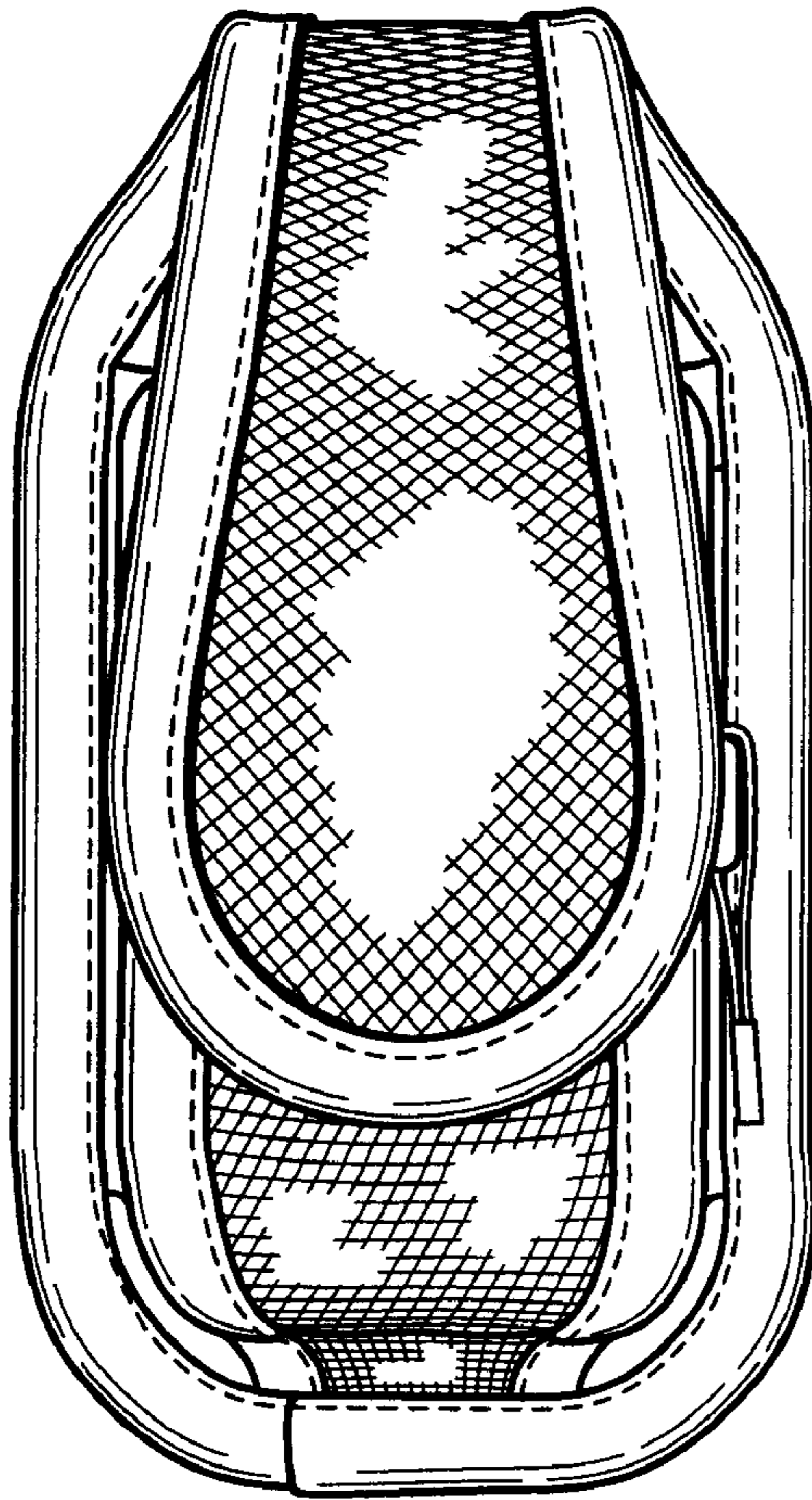

FIG. 3

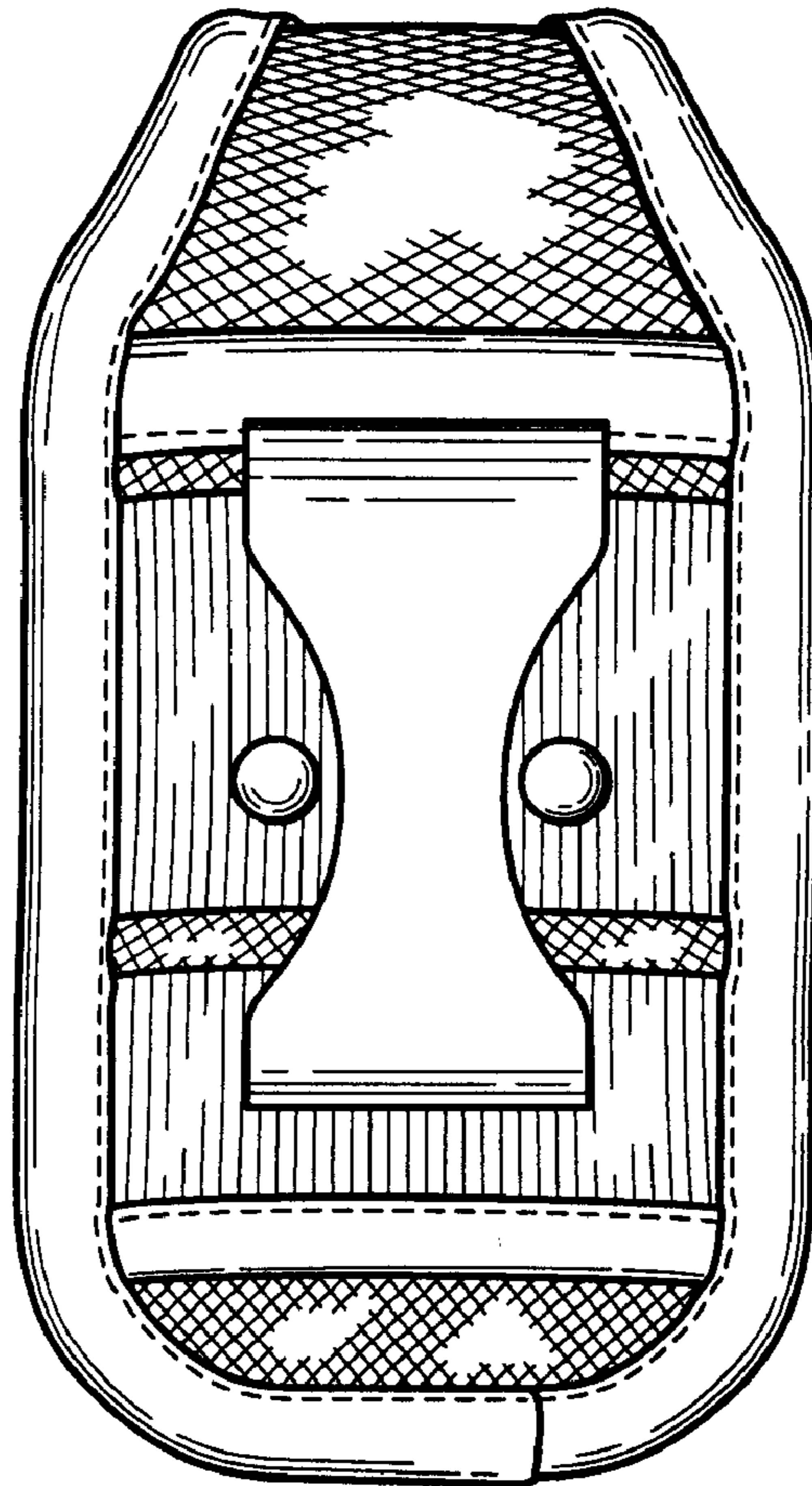

FIG. 4

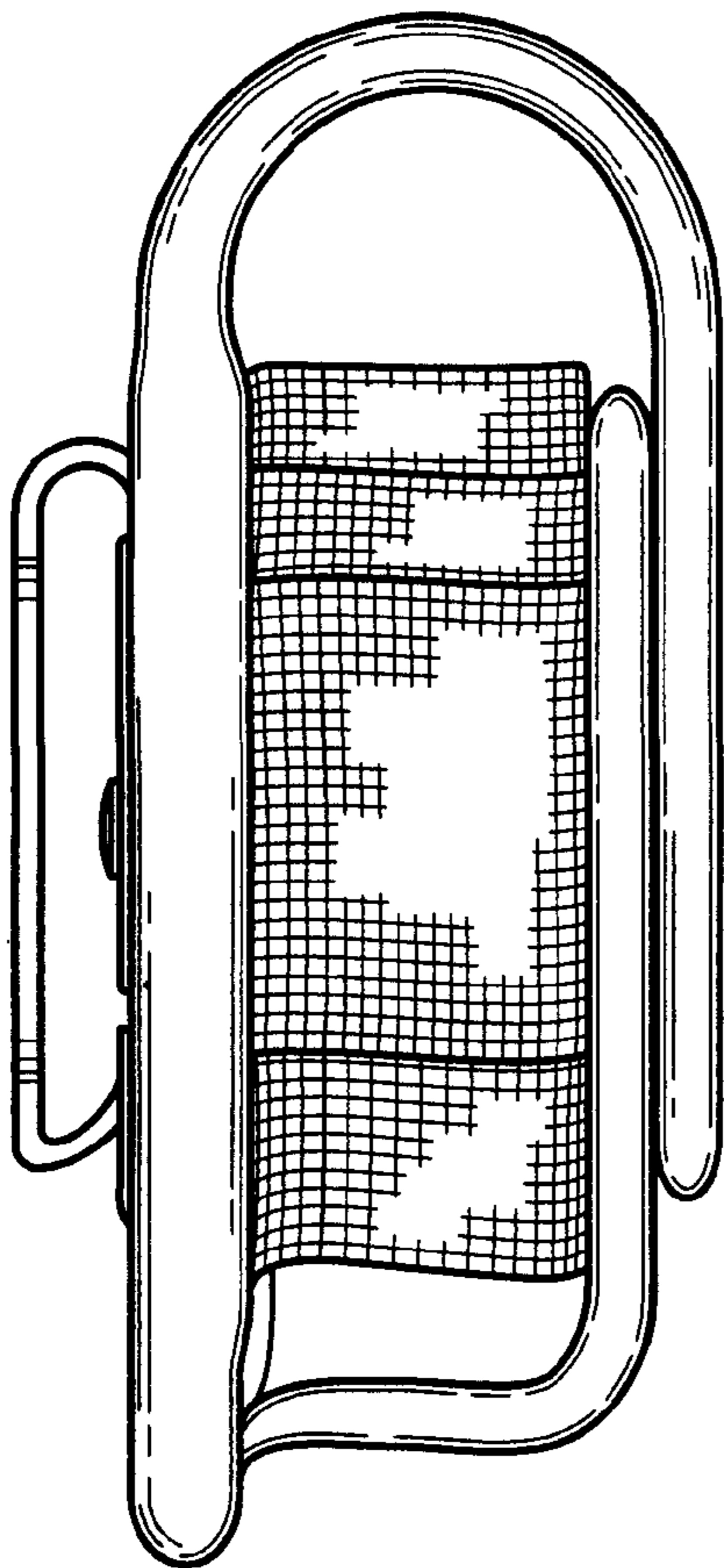

FIG. 5

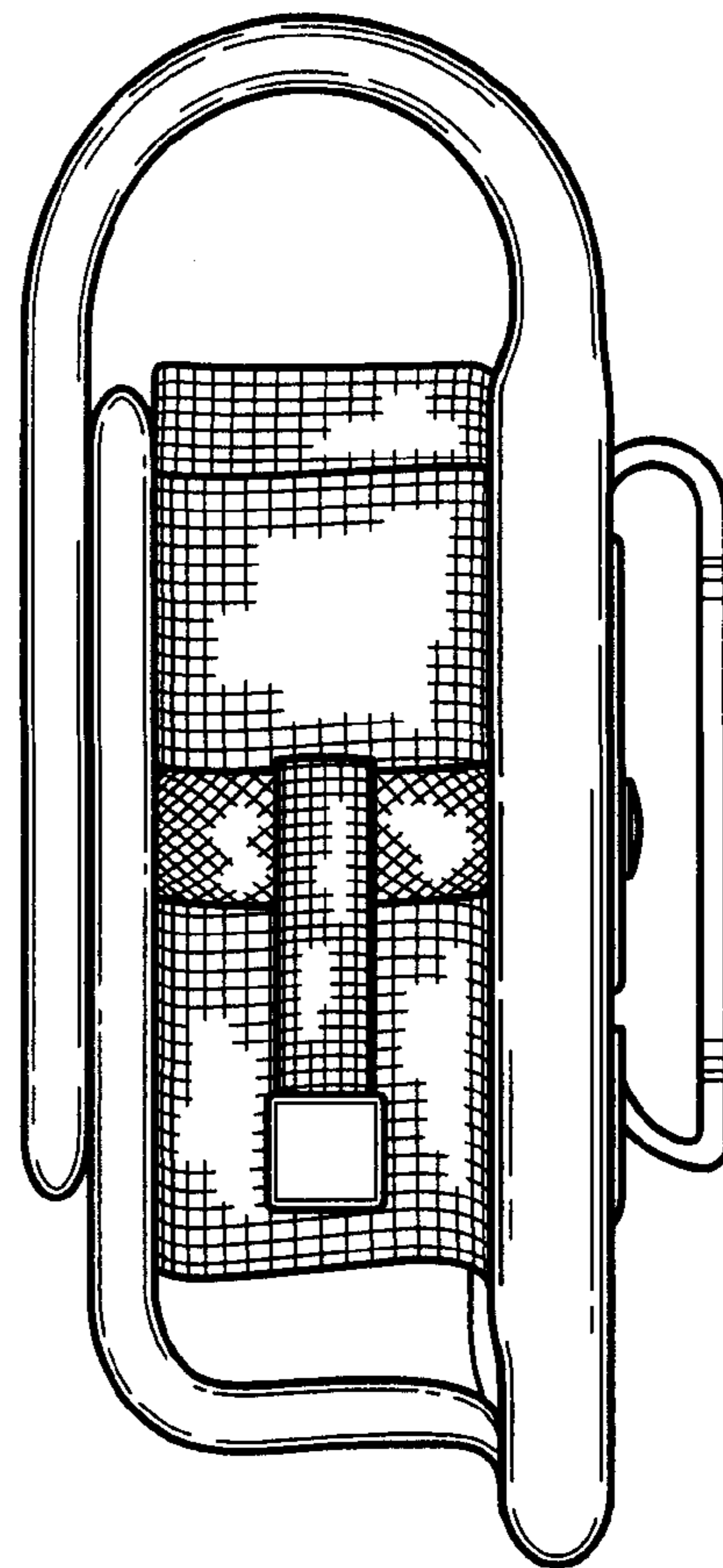

FIG. 6

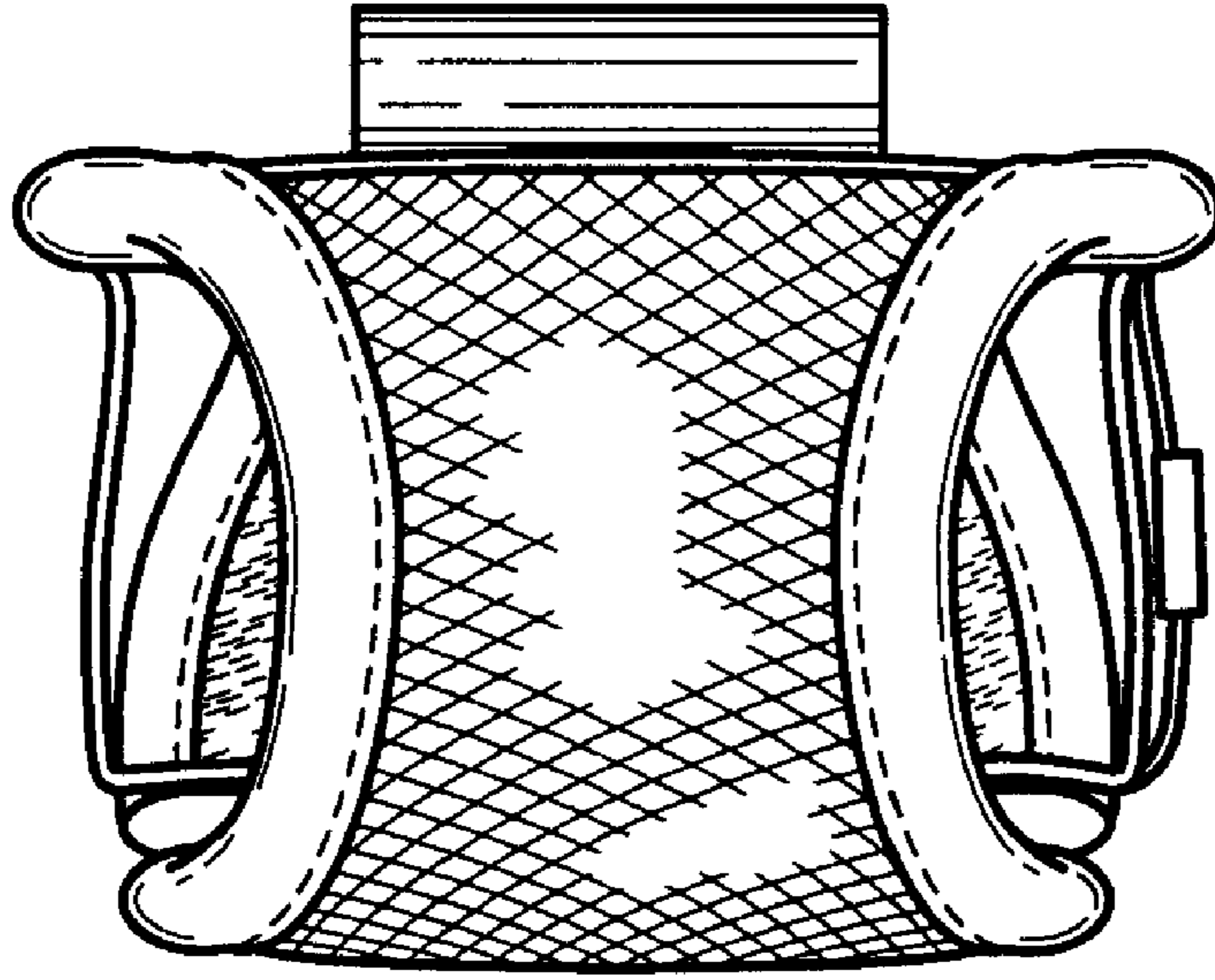

FIG. 7

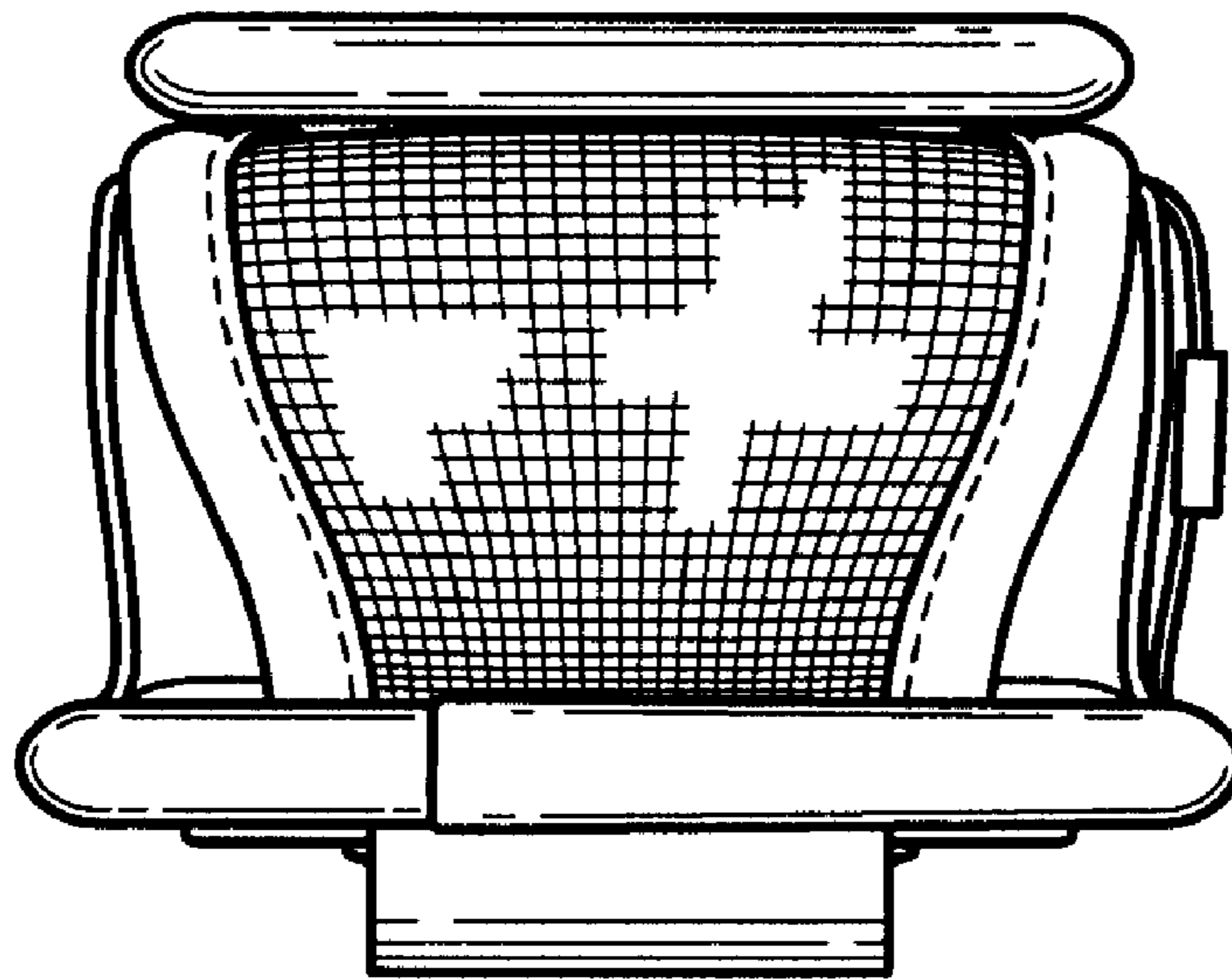

FIG. 8

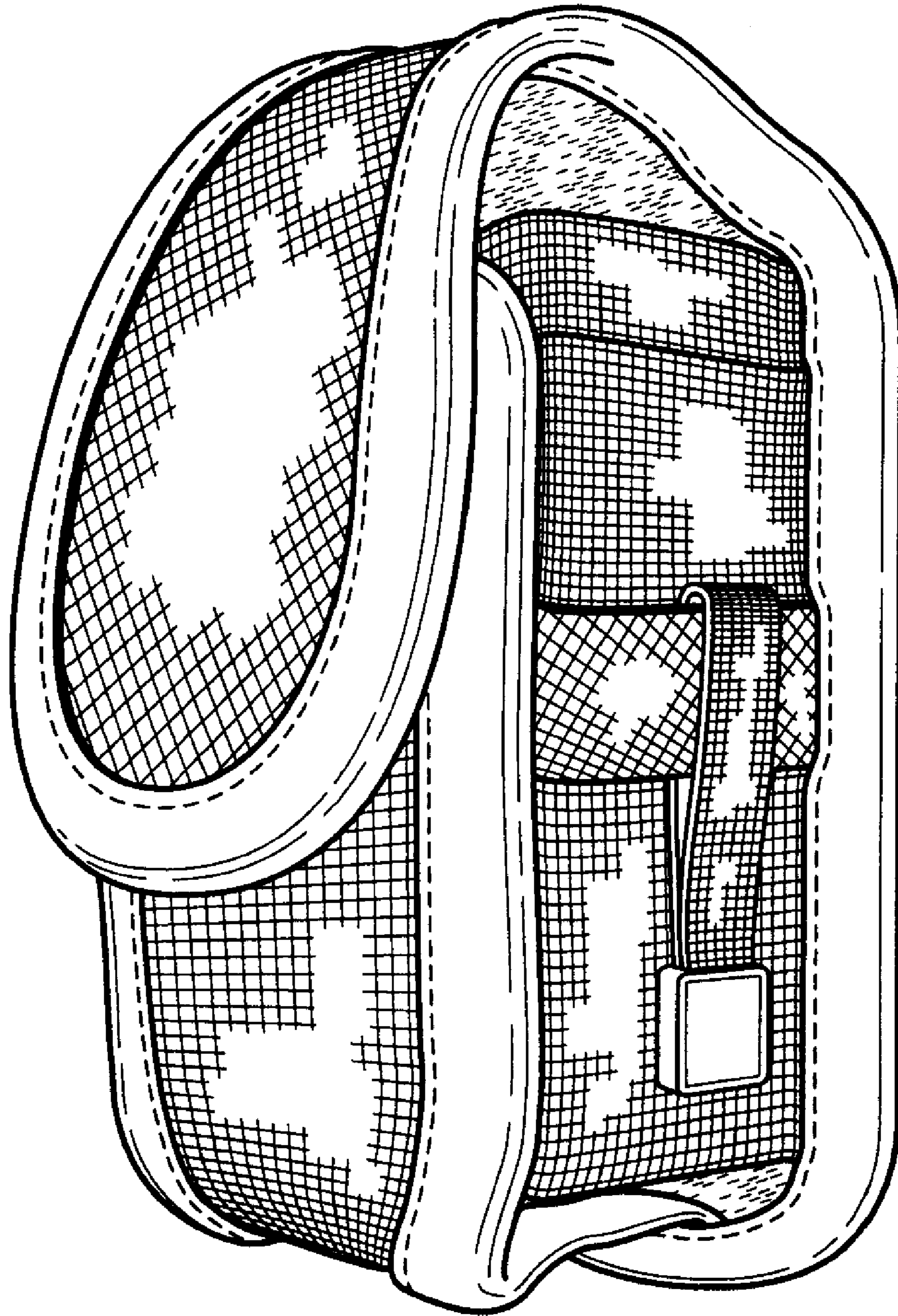

FIG. 9

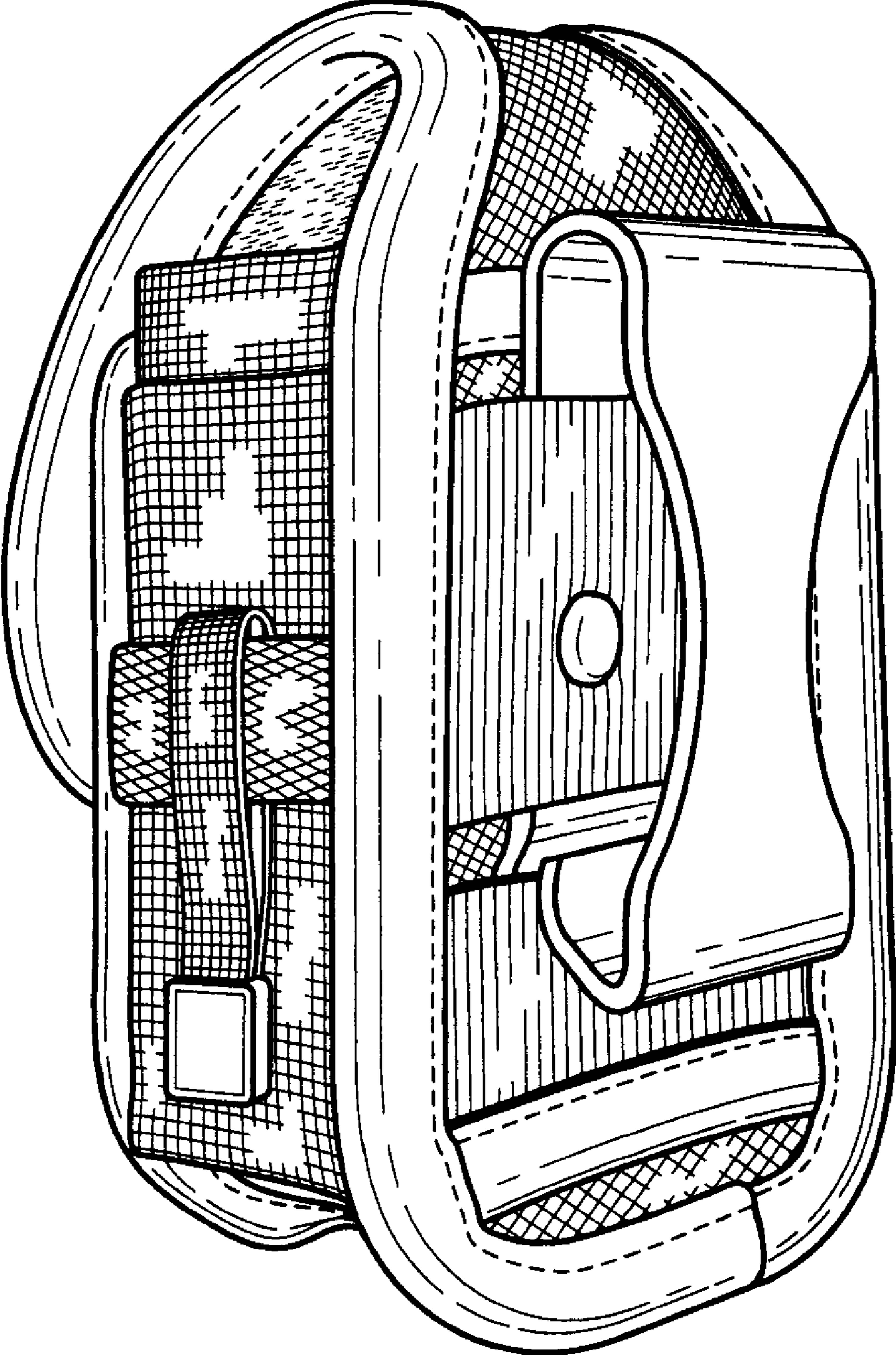

FIG. 10

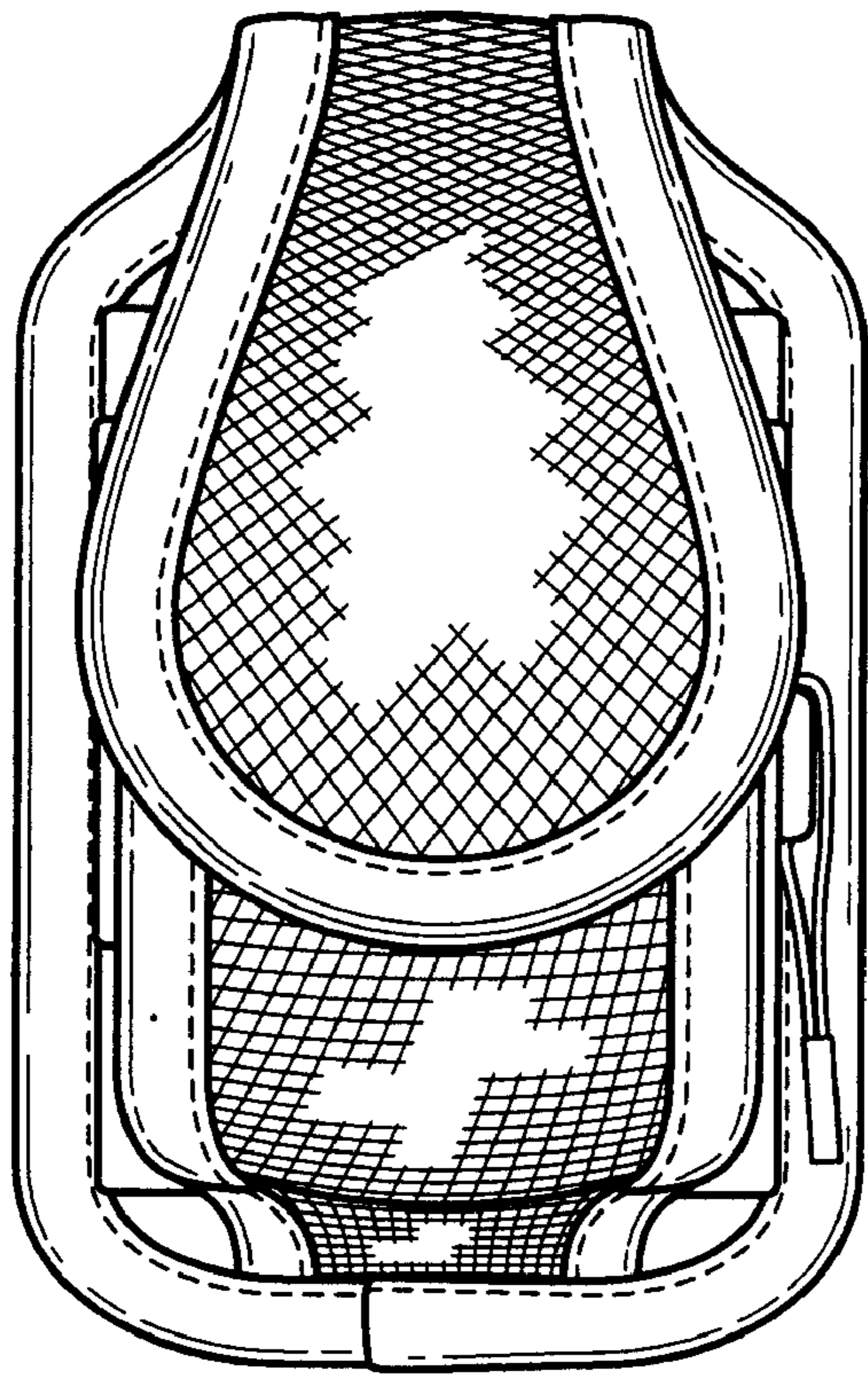
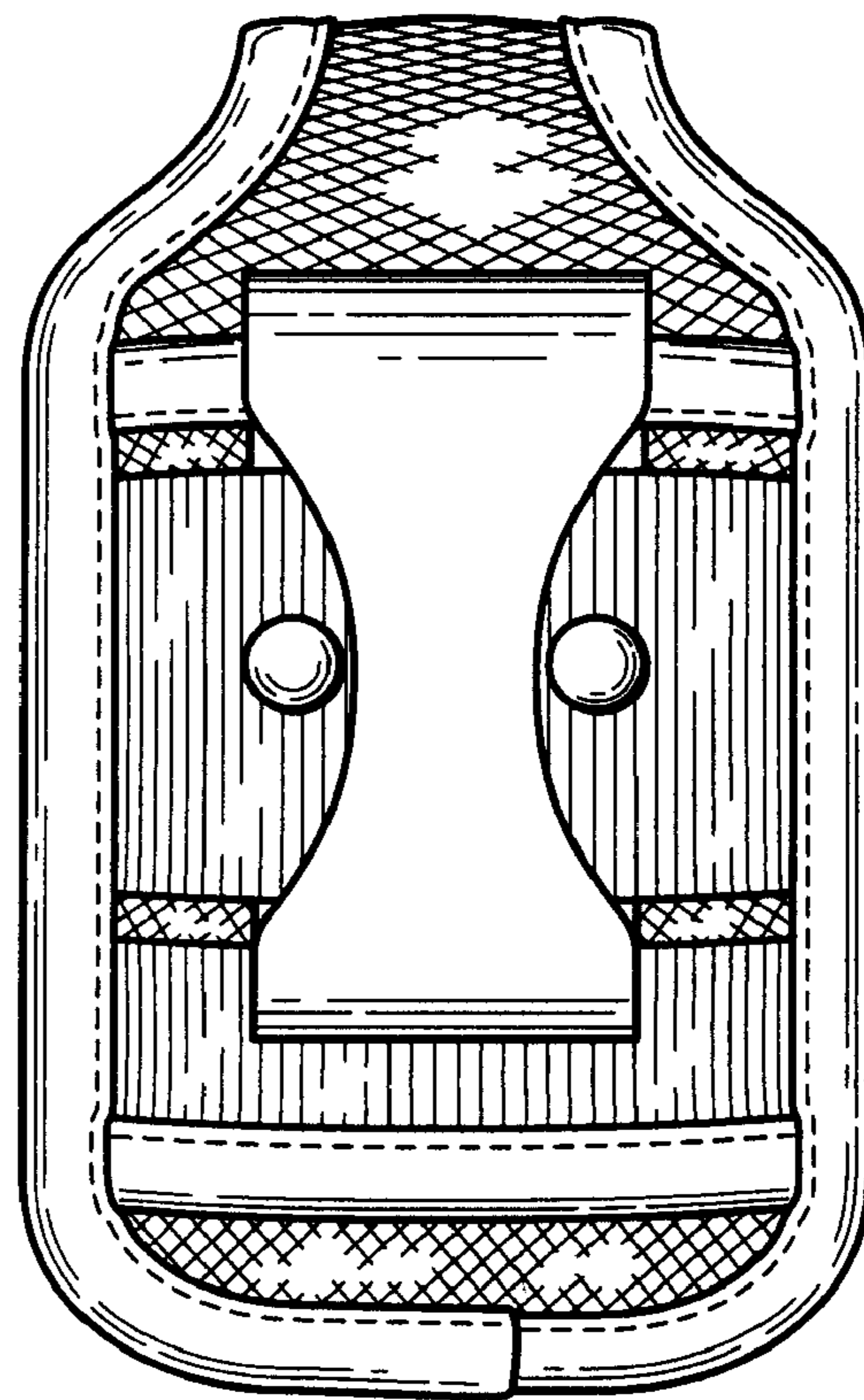

FIG. 11

FIG. 12



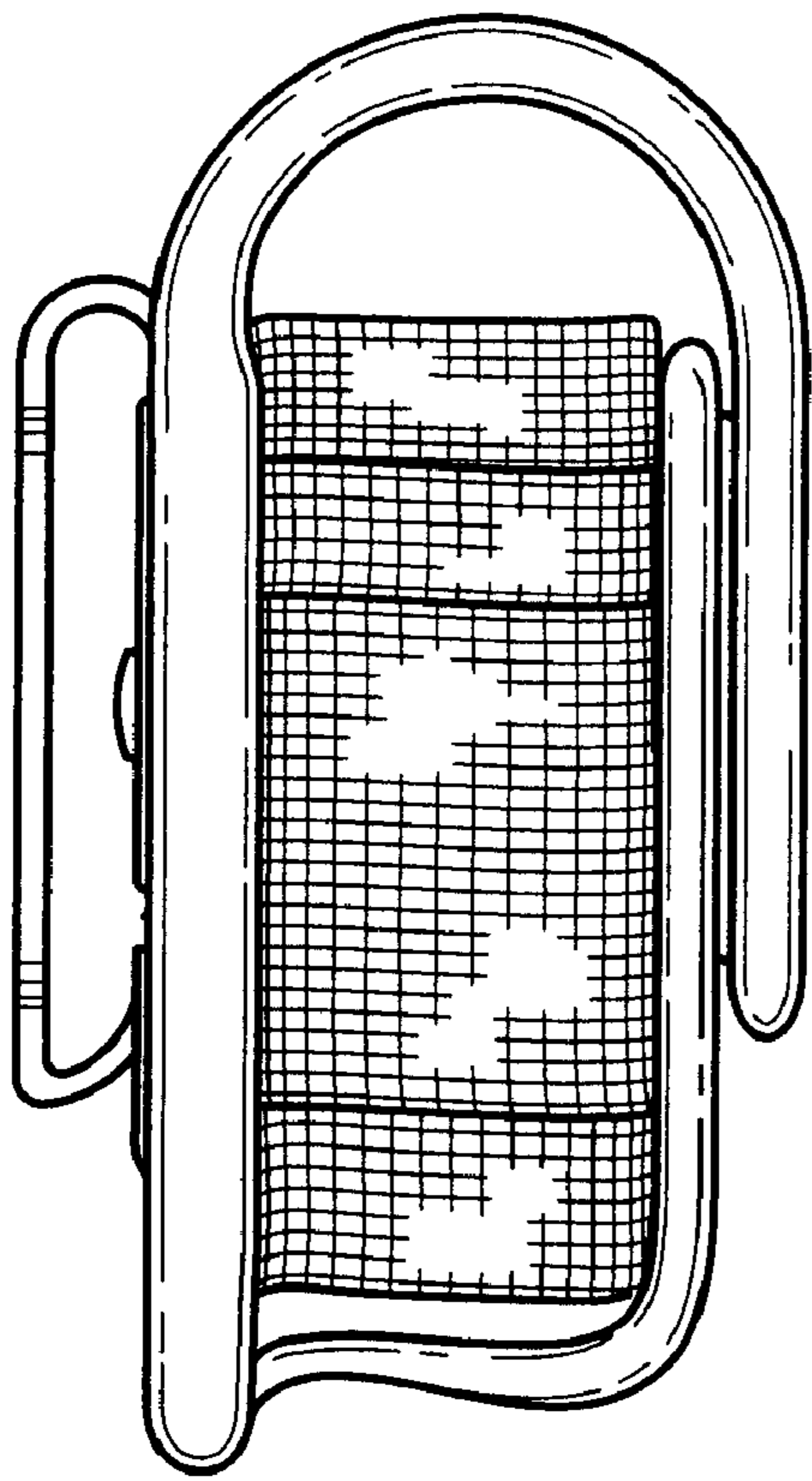

FIG. 13

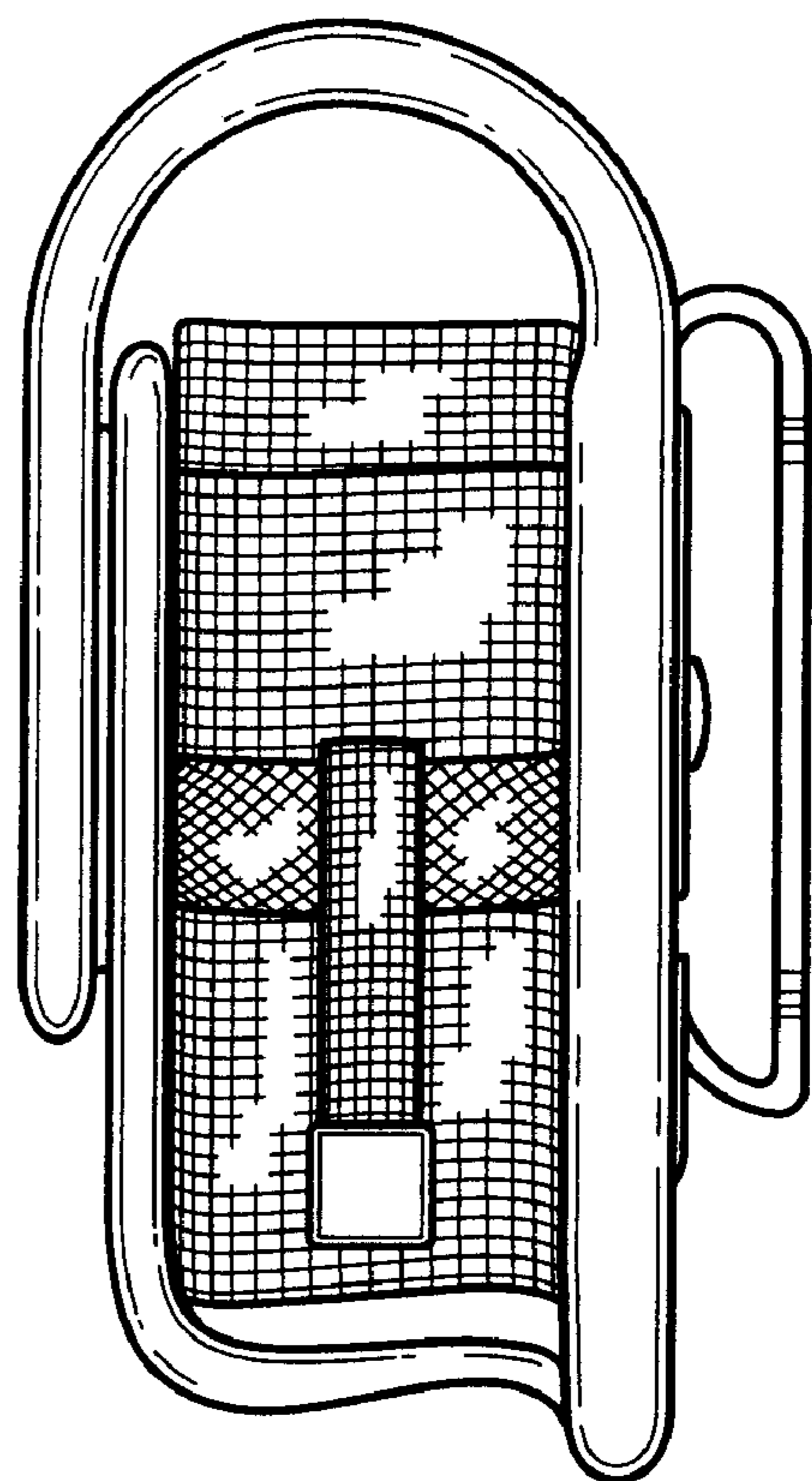

FIG. 14

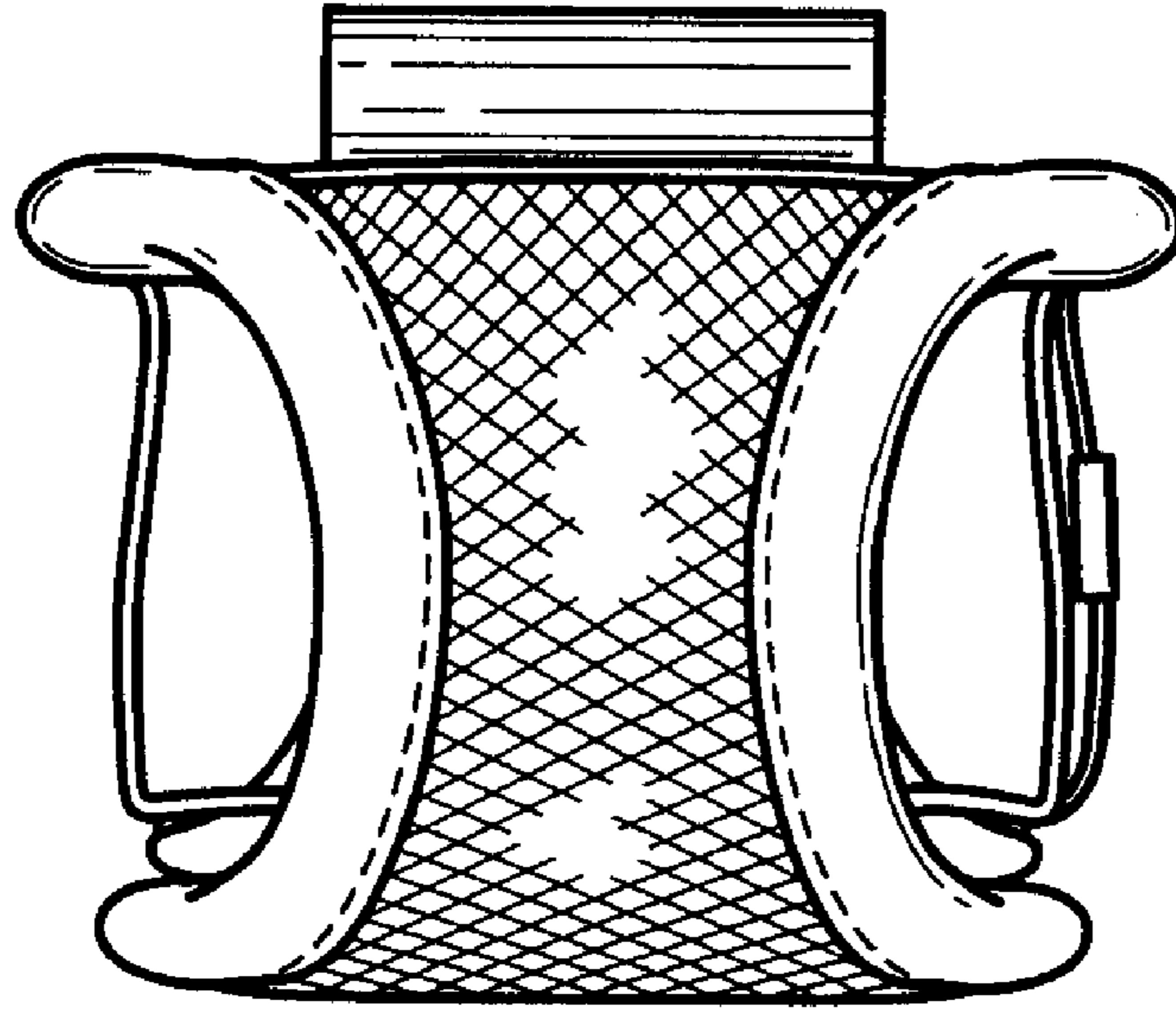

FIG. 15

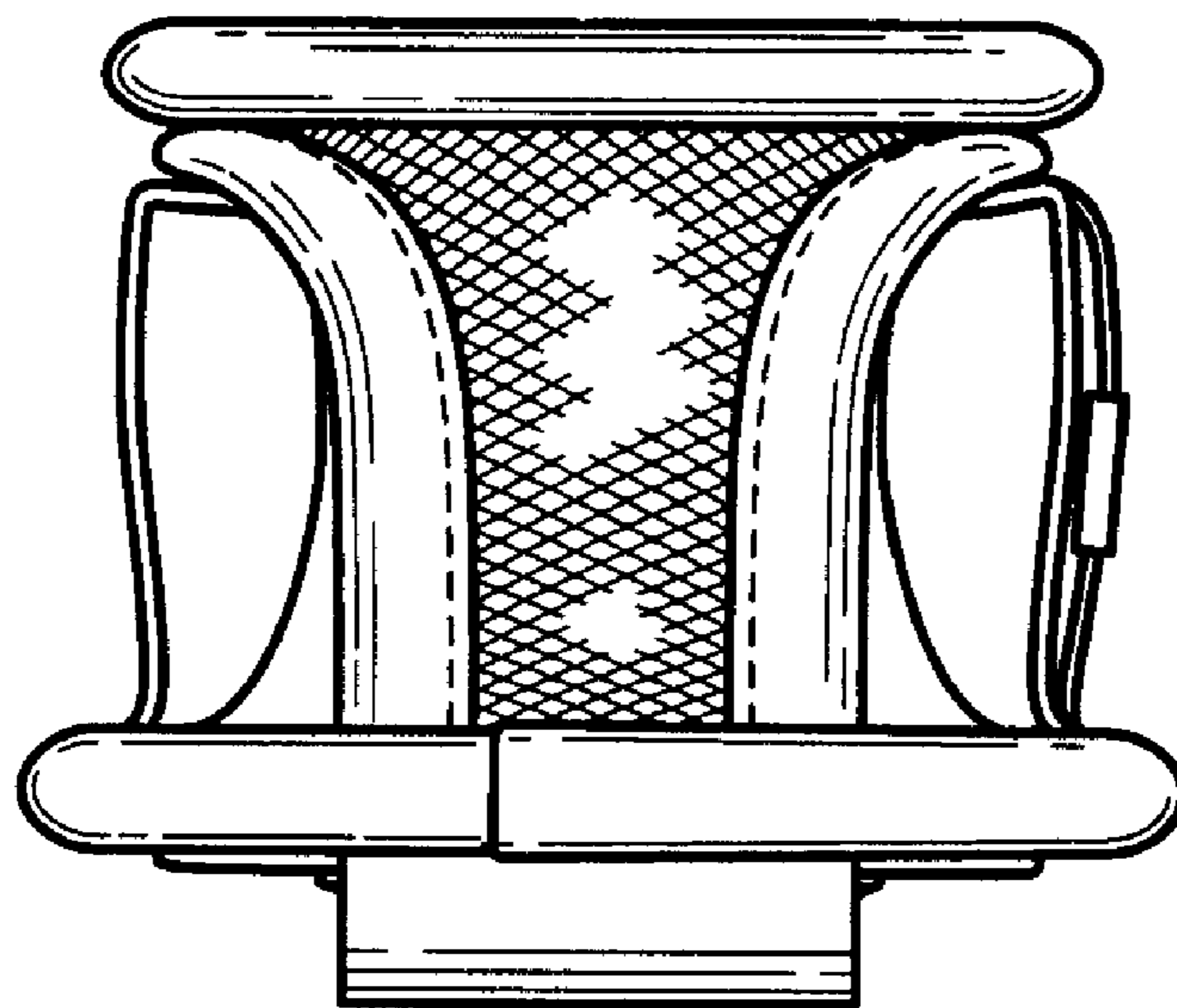

FIG. 16