



US00D549853S

(12) **United States Design Patent** (10) **Patent No.:** **US D549,853 S**
Walker et al. (45) **Date of Patent:** **** Aug. 28, 2007**

(54) **ADJUSTABLE POST SUPPORT**

FOREIGN PATENT DOCUMENTS

(75) Inventors: **Simon Walker**, Vancouver (CA);
Clinton Lee, Vancouver (CA)

DE 19748783 C1 11/1999
EP 0657604 B1 1/1996

(73) Assignee: **Peak Innovations Inc.**, Richmond (CA)

* cited by examiner

(**) Term: **14 Years**

Primary Examiner—Doris Clark

(74) *Attorney, Agent, or Firm*—Mark Hopkinson

(21) Appl. No.: **29/190,600**

(57) **CLAIM**

(22) Filed: **Sep. 25, 2003**

The ornamental design for an adjustable post support, as shown and described.

(30) **Foreign Application Priority Data**

DESCRIPTION

Apr. 10, 2003 (CA) 102662

(51) **LOC (8) Cl.** **25-01**

(52) **U.S. Cl.** **D25/131**

(58) **Field of Classification Search** D25/131,
D25/126, 127; 405/244; 248/545, 546, 530,
248/532, 511, 519, 516, 541; 52/155, 158,
52/159, 165, 146

See application file for complete search history.

FIG. 1 is a front elevation of a first embodiment of our adjustable post support;

FIG. 2 is a left side elevation of FIG. 1;

FIG. 3 is a rear elevation of FIG. 1;

FIG. 4 is a right side elevation of FIG. 1;

FIG. 5 is a top plan view of FIG. 1;

FIG. 6 is a bottom plan view of FIG. 1;

FIG. 7 is an exploded perspective view of FIG. 1;

FIG. 8 is a front elevation of a second embodiment of our adjustable post support wherein the second variant has clamping flanges located in a corner of a top box;

FIG. 9 is a left side elevation of FIG. 8;

FIG. 10 is a rear elevation of FIG. 8;

FIG. 11 is a right side elevation of FIG. 8;

FIG. 12 is a top plan view of FIG. 8;

FIG. 13 is a bottom plan view of FIG. 8; and,

FIG. 14 is an exploded perspective view of FIG. 8.

(56) **References Cited**

U.S. PATENT DOCUMENTS

4,874,149 A * 10/1989 Miceli 248/530
5,709,366 A * 1/1998 Speece 248/530
5,884,874 A 3/1999 Speece et al.
5,927,677 A 7/1999 Speece et al.
6,039,298 A * 3/2000 Stier 248/545
D424,713 S * 5/2000 Blackwell D25/131
6,273,390 B1 8/2001 Meyer
6,308,926 B1 10/2001 Meyer

1 Claim, 8 Drawing Sheets



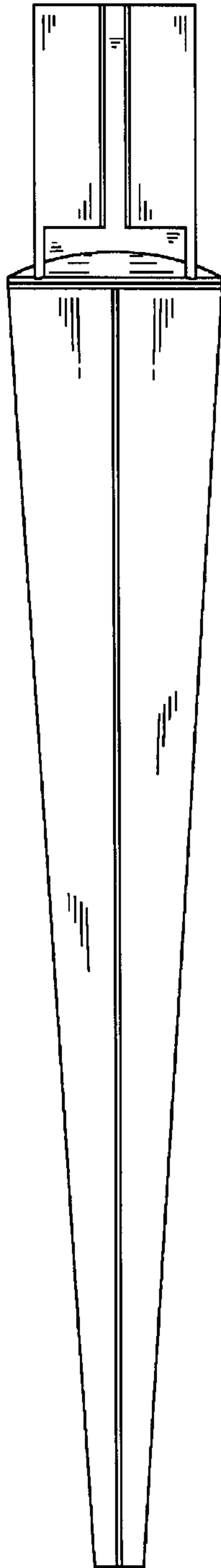

Fig. 1

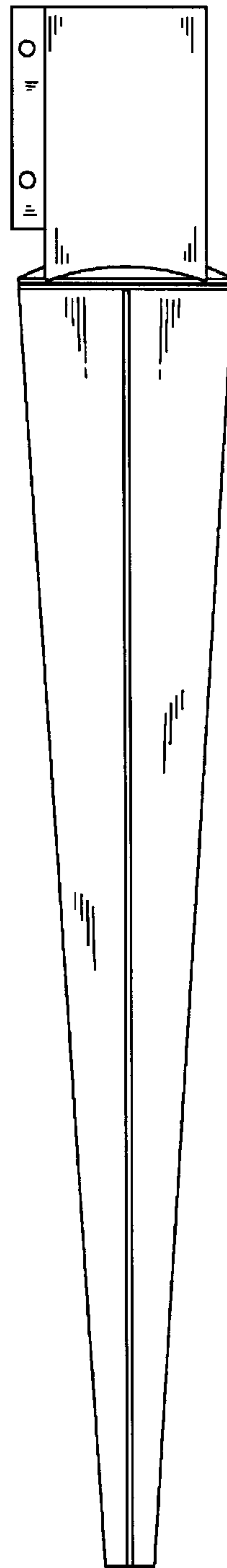

Fig. 2

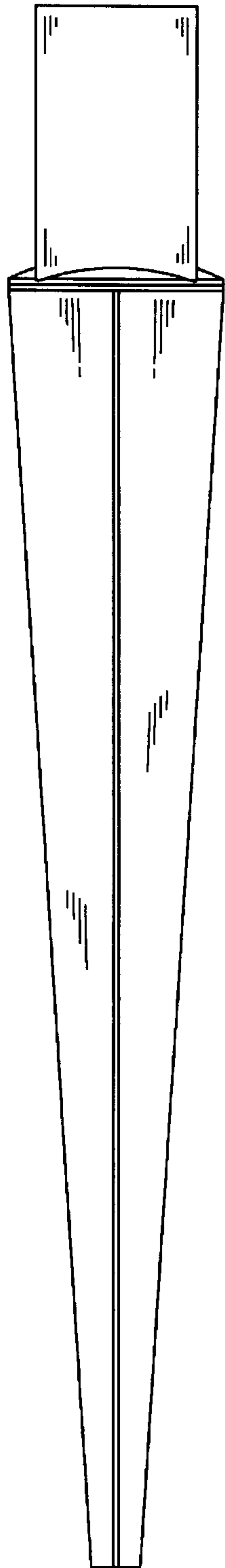

Fig. 3

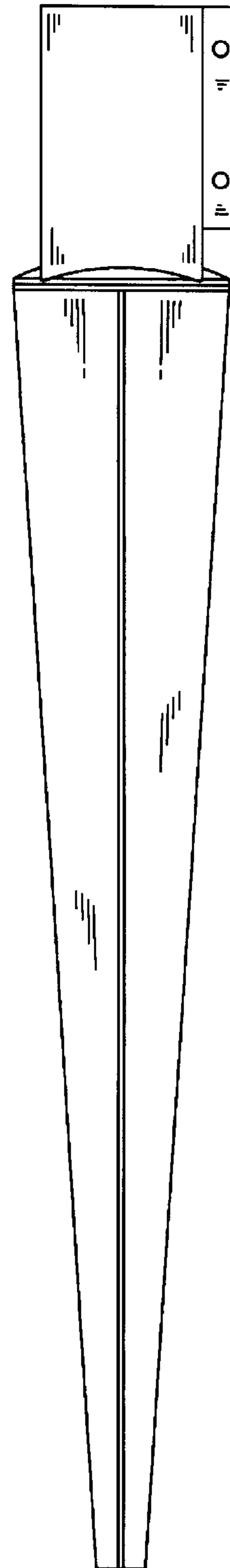

Fig. 4

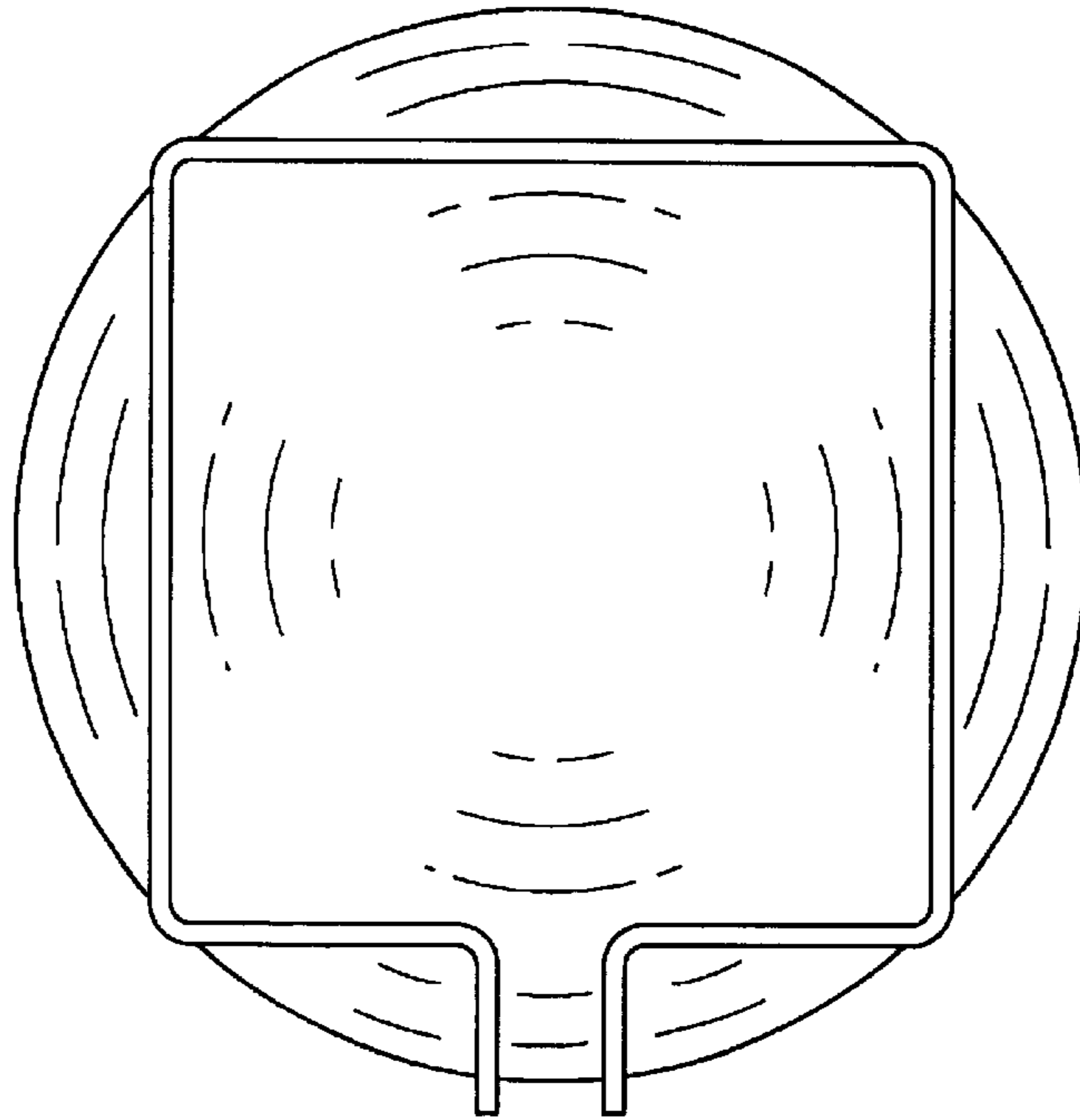

Fig. 5

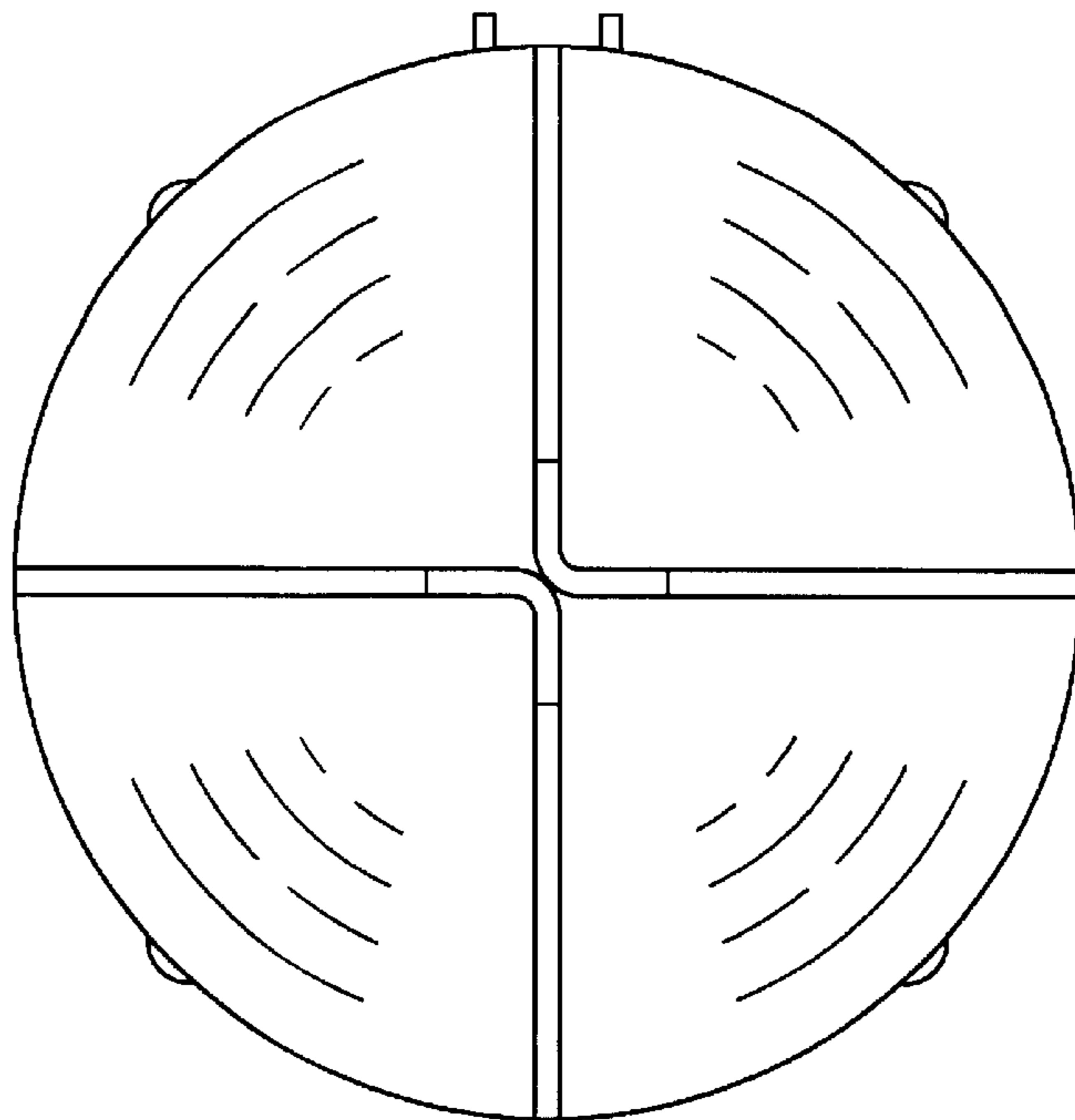

Fig. 6

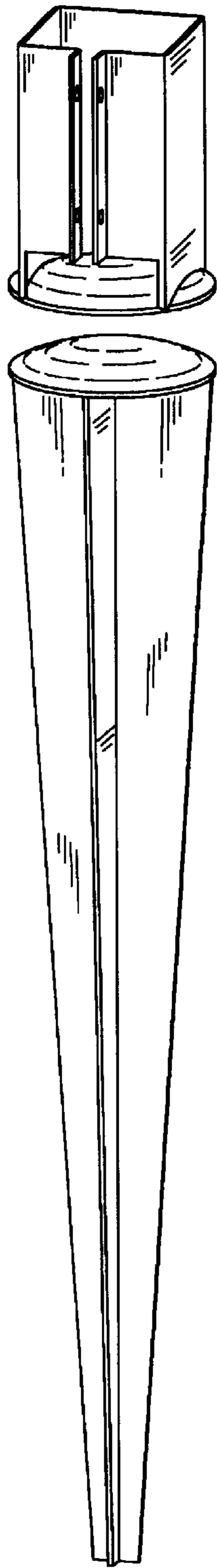

Fig. 7

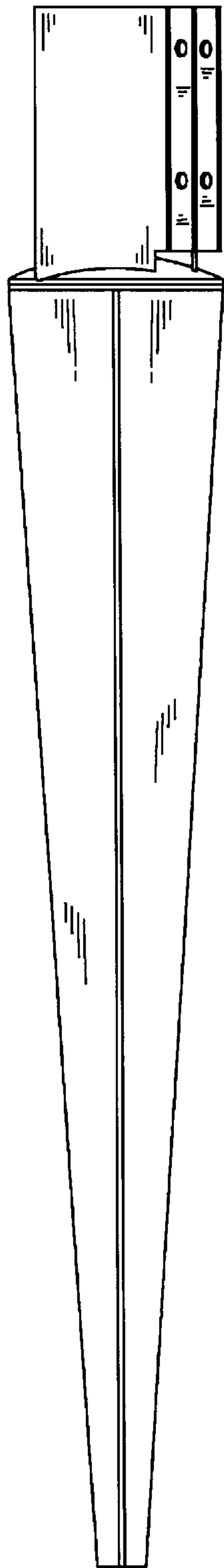

Fig. 8

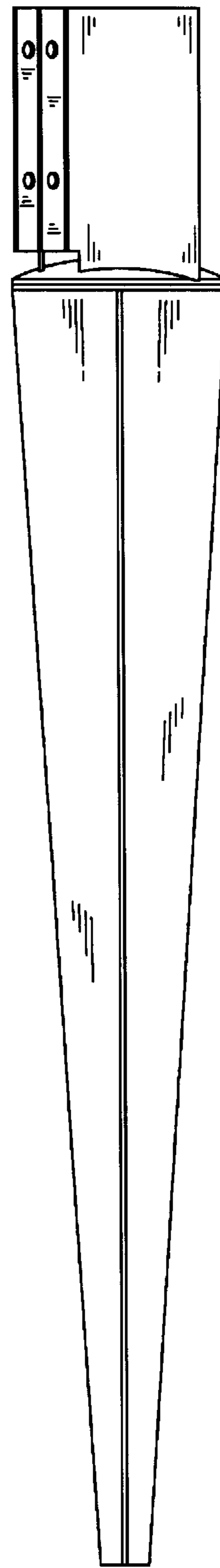

Fig. 9

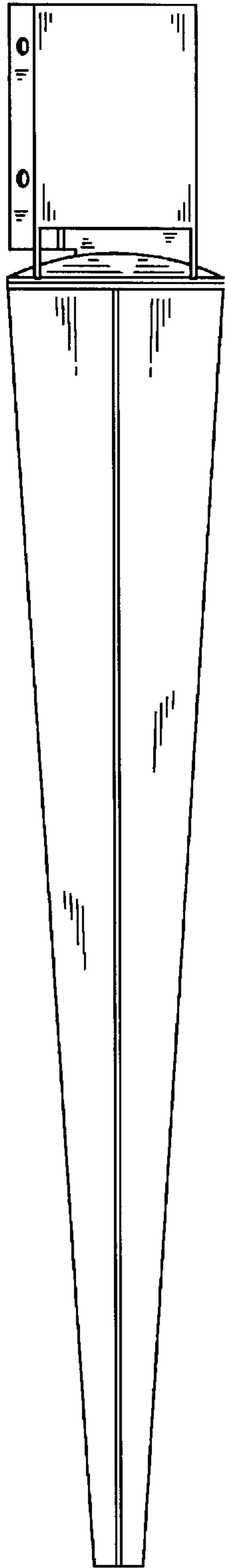

Fig. 10

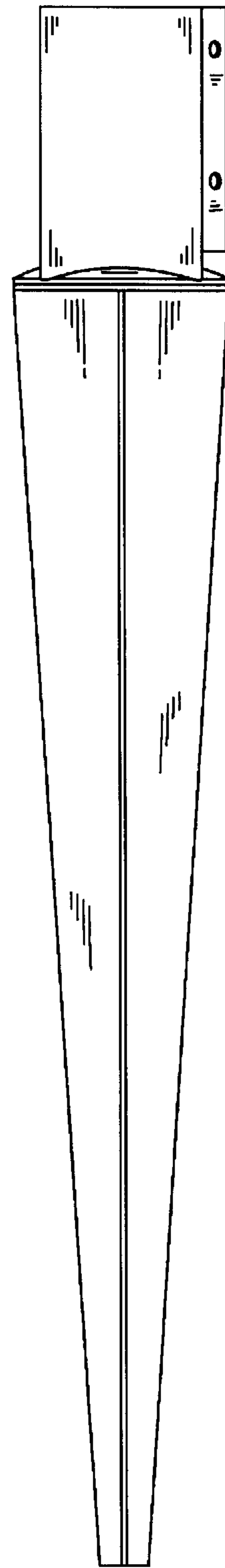

Fig. 11

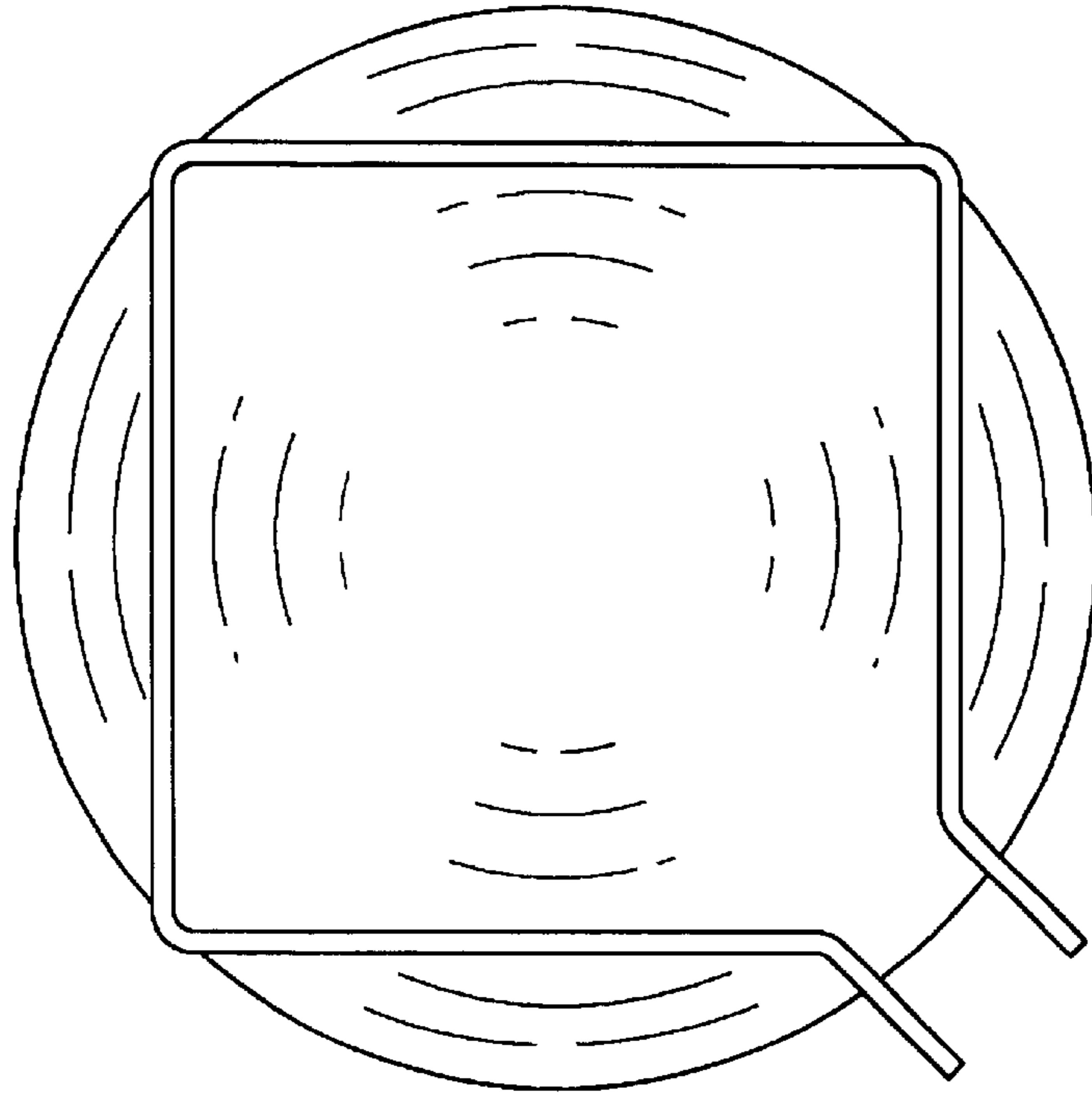

Fig. 12

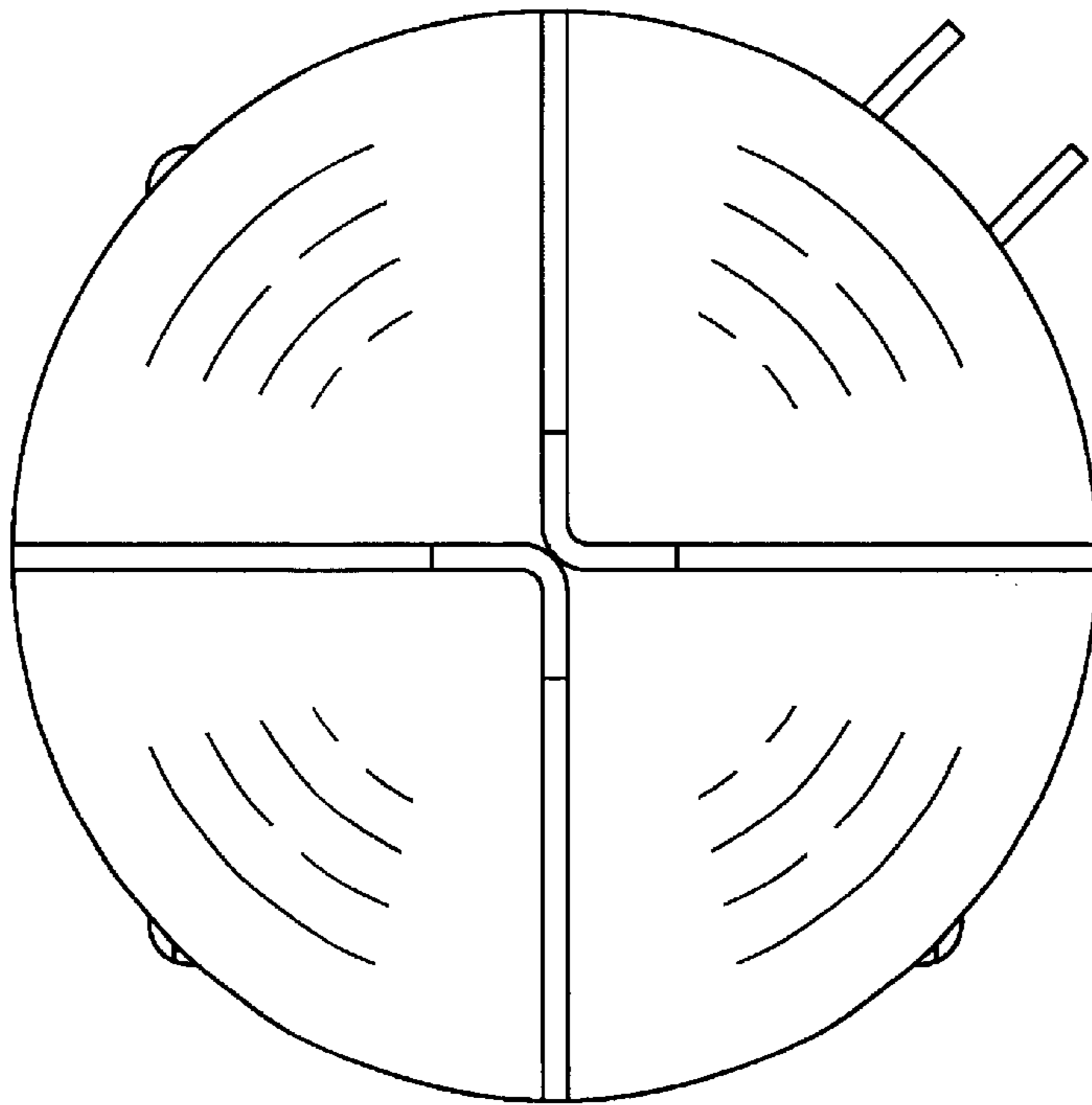

Fig. 13

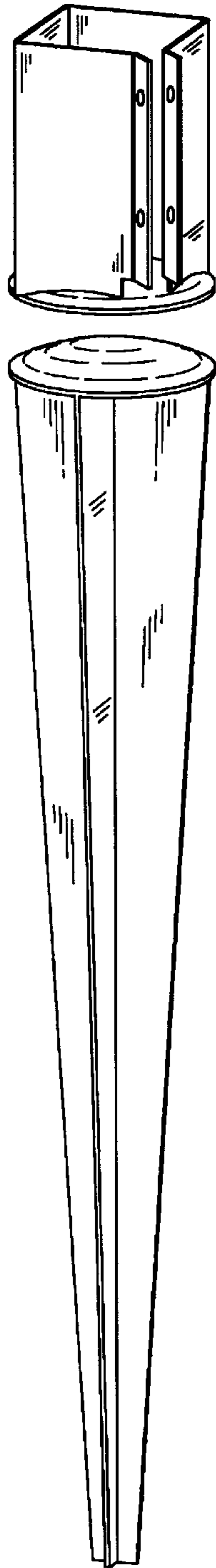

Fig. 14