

US00D549851S

(12) **United States Design Patent**
Antonic

(10) **Patent No.:** **US D549,851 S**

(45) **Date of Patent:** **** Aug. 28, 2007**

(54) **SILL PLATE**

(76) **Inventor:** **James P. Antonic**, 9111 Southmont
Cove #406, Ft. Myers, FL (US) 33908

(**) **Term:** **14 Years**

(21) **Appl. No.:** **29/258,892**

(22) **Filed:** **Apr. 28, 2006**

Related U.S. Application Data

(63) Continuation of application No. 11/249,650, filed on Oct.
13, 2005.

(51) **LOC (8) Cl.** **25-01**

(52) **U.S. Cl.** **D25/119**

(58) **Field of Classification Search** D25/119,
D25/122; 52/281, 282.2, 282.3, 460, 461,
52/479, 481.1, 220.1

See application file for complete search history.

(56) **References Cited**

U.S. PATENT DOCUMENTS

- D283,352 S * 4/1986 Bancroft D25/119
- 4,660,339 A * 4/1987 Paz 52/238.1
- 5,070,667 A * 12/1991 Schulte 52/241
- 5,561,955 A * 10/1996 Frobosilo et al. 52/217

- 5,794,746 A * 8/1998 Ketonen et al. 187/333
- 5,797,233 A * 8/1998 Hascall 52/481.1
- D423,690 S * 4/2000 Grosfillex D25/119

OTHER PUBLICATIONS

U.S. Appl. No. 29/258,890, filed Apr. 28, 2006, Antonic.

U.S. Appl. No. 29/258,891, filed Apr. 28, 2006, Antonic.

* cited by examiner

Primary Examiner—Doris Clark

(74) *Attorney, Agent, or Firm*—Laura G. Barrow

(57) **CLAIM**

I claim the ornamental design of a sill plate, as shown and described.

DESCRIPTION

FIG. 1 is a perspective view of the sill plate showing my new design, shown broken in the center to indicate indeterminate length.

FIG. 2 is a front elevation thereof.

FIG. 3 is a rear elevation thereof.

FIG. 4 is a side elevation view thereof. The right and left sides of the sill plate are identical.

FIG. 5 is a top plan view thereof; and,

FIG. 6 is a bottom plan view thereof.

1 Claim, 3 Drawing Sheets

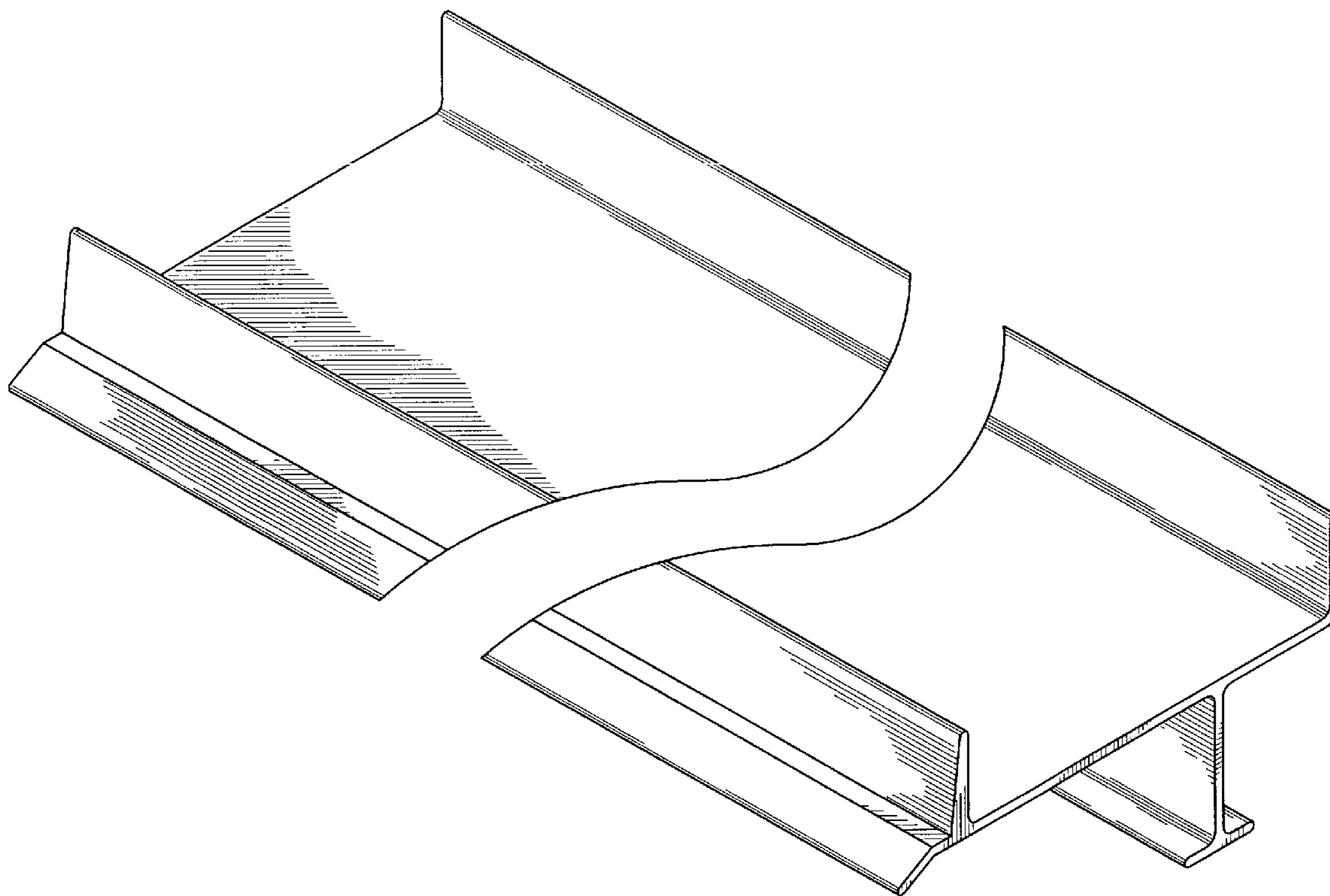

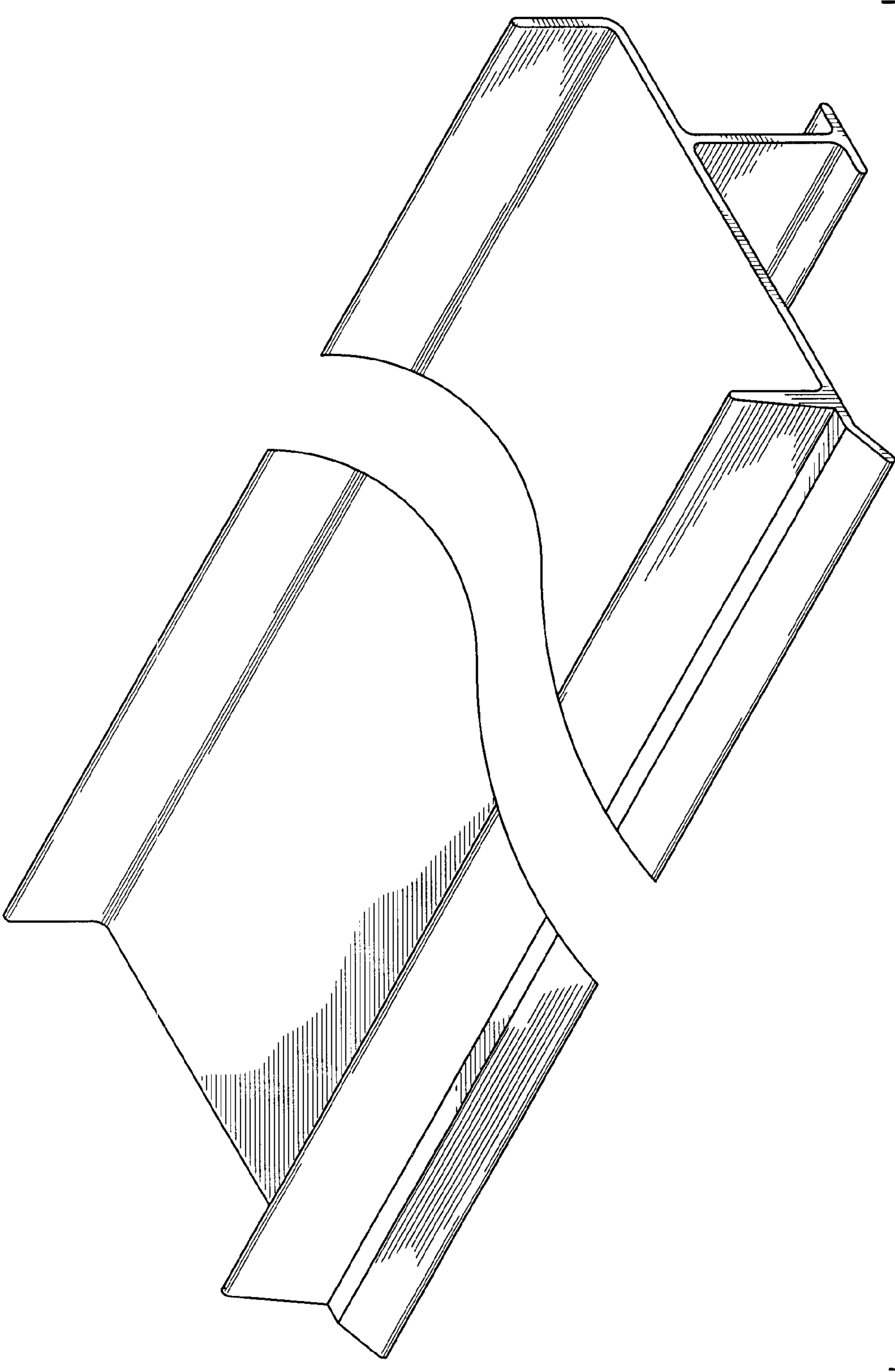

Fig. 1

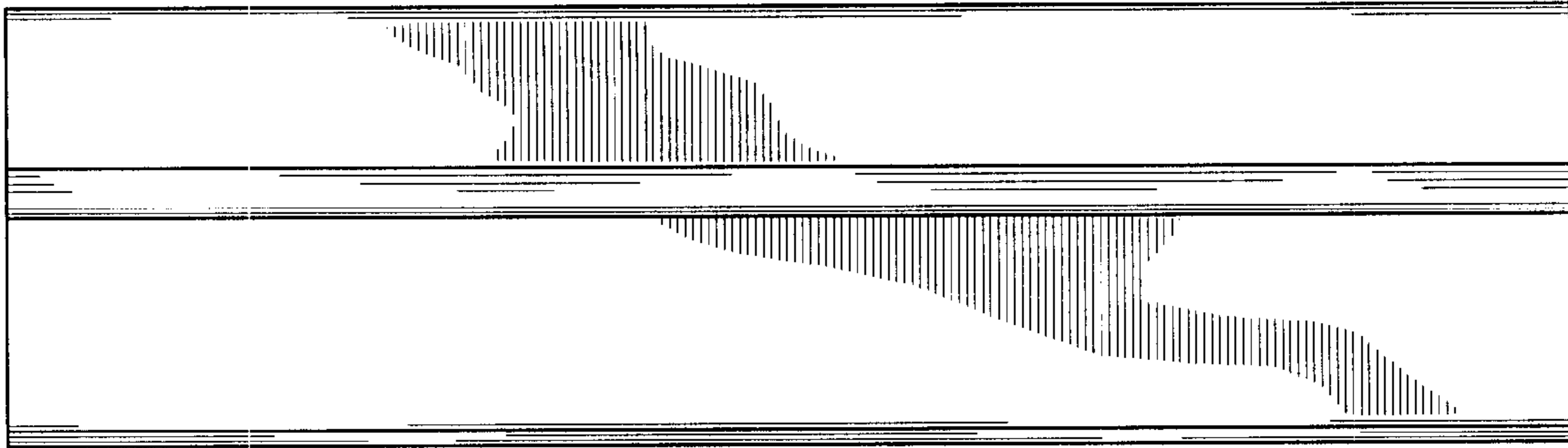

Fig. 2

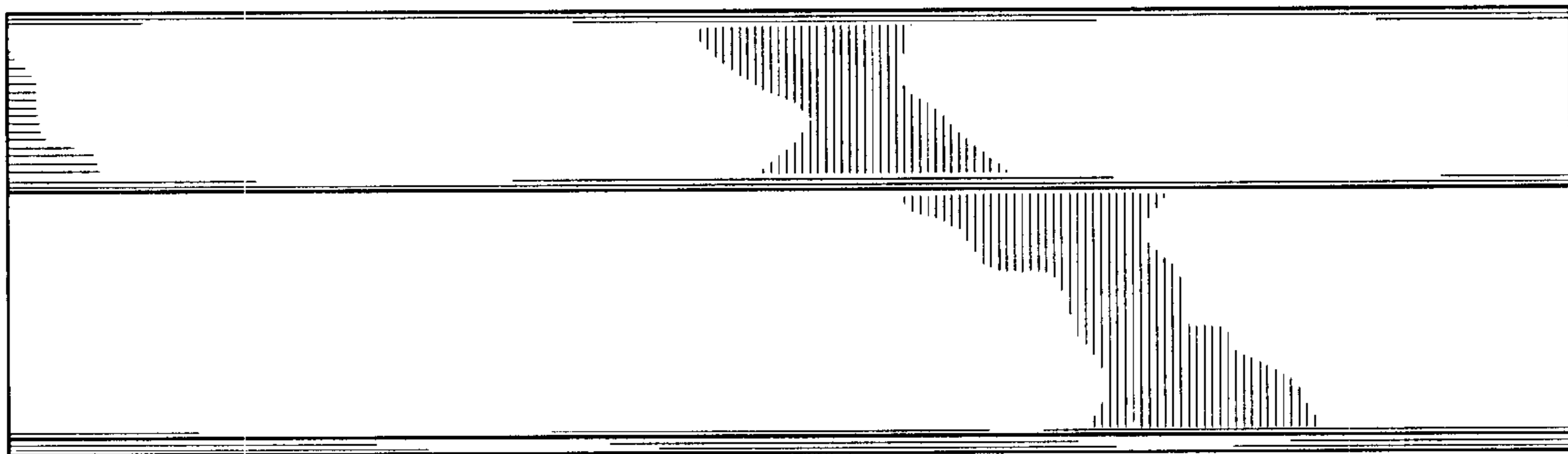

Fig. 3

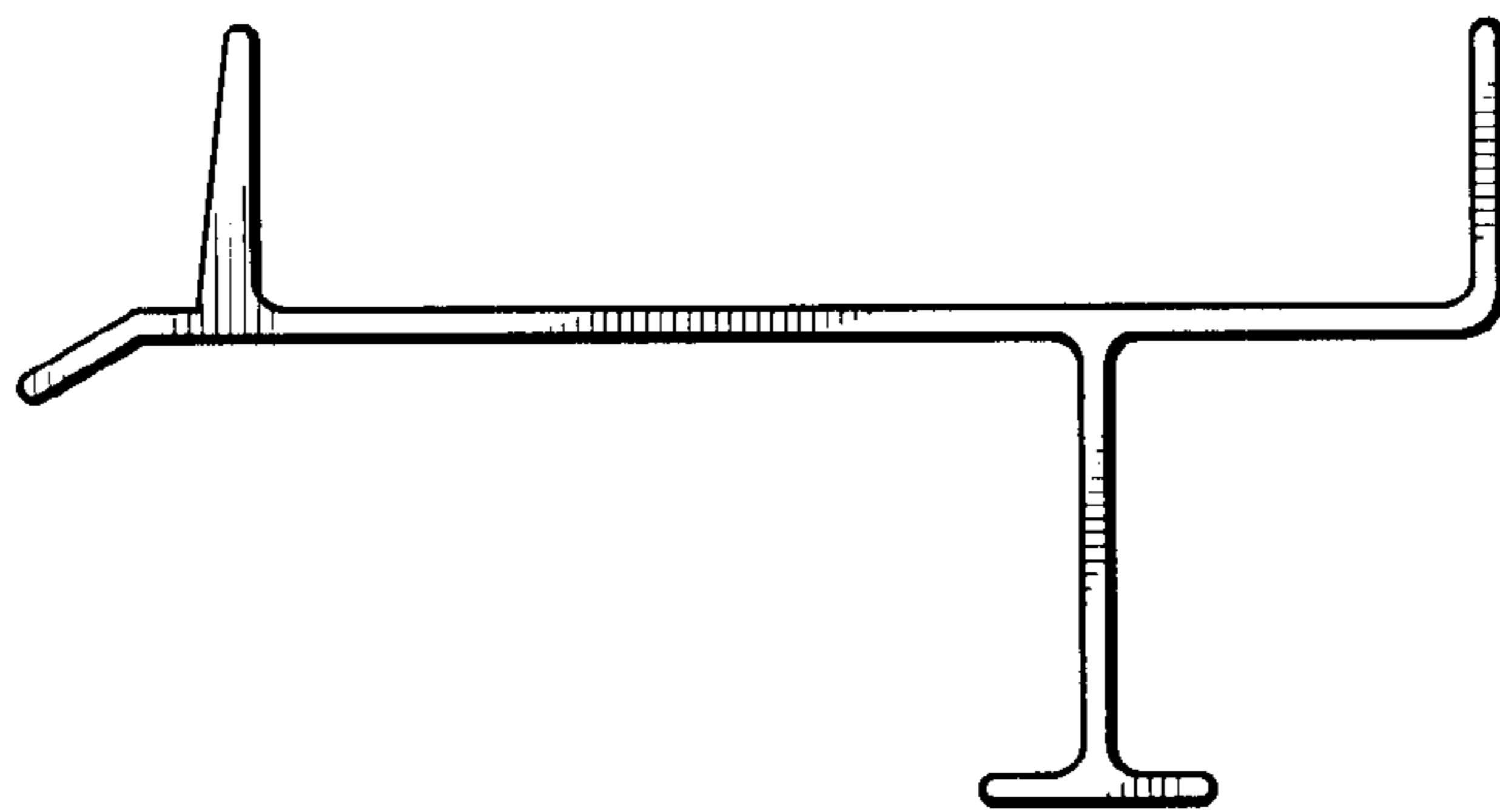

Fig. 4

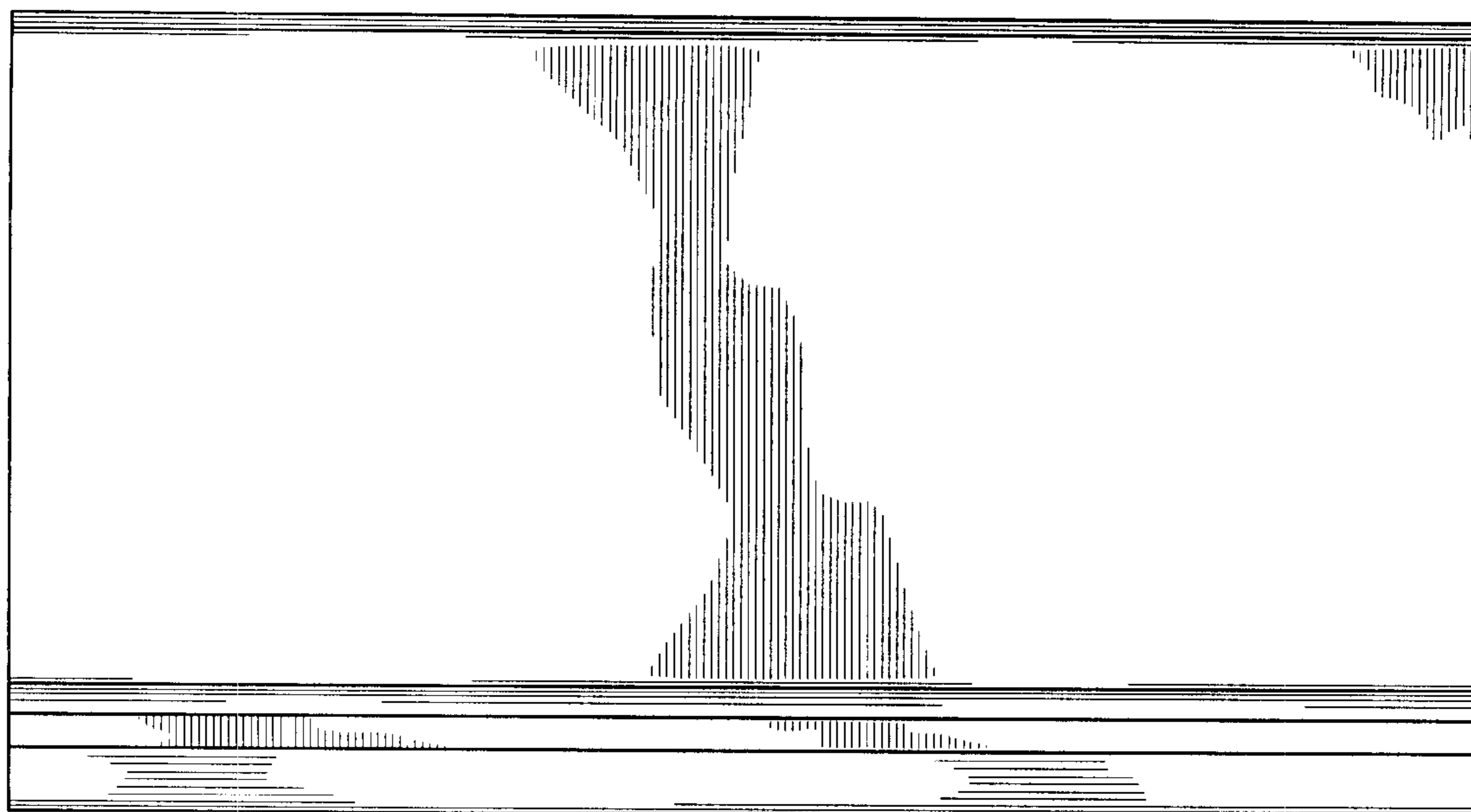

Fig. 5

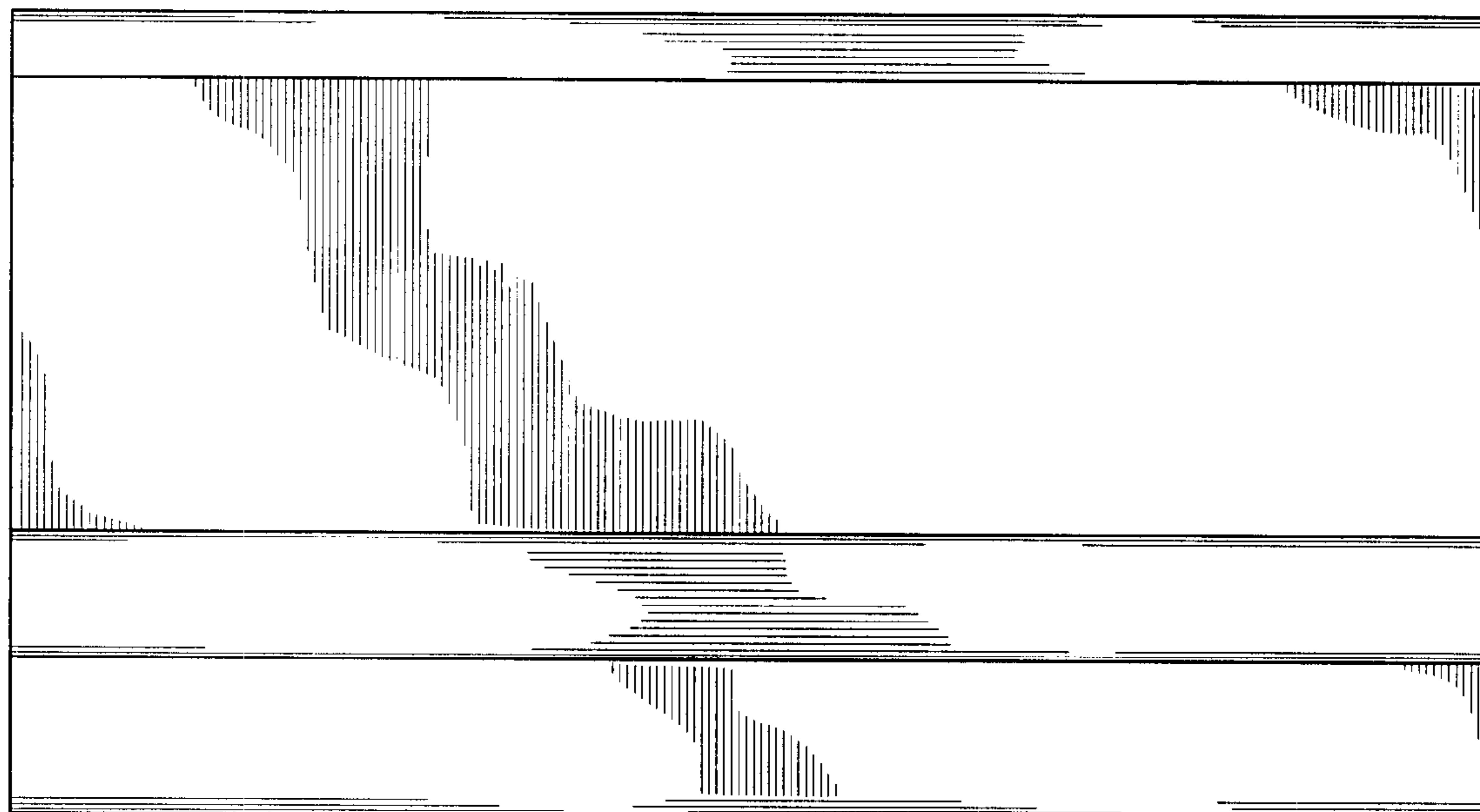

Fig. 6