



US00D549706S

(12) **United States Design Patent**
Doyle et al.

(10) **Patent No.:** **US D549,706 S**
(45) **Date of Patent:** **** Aug. 28, 2007**

(54) **FRAME FOR AN EMI SHIELD ASSEMBLY**
(75) Inventors: **Peter John Doyle**, Los Altos, CA (US);
Gerald Robert English, Glen Ellyn, IL
(US); **Allan Richard Zuehlsdorf**,
Sycamore, IL (US); **Aleksey Pirkhalo**,
Buffalo Grove, IL (US)

5,252,782 A 10/1993 Cantrell et al.
5,354,951 A 10/1994 Lange, Sr. et al.
5,365,410 A 11/1994 Lonka
5,383,098 A 1/1995 Ma et al.
5,422,433 A 6/1995 Rivera et al.
5,436,802 A 7/1995 Trahan et al.

(Continued)

(73) Assignee: **Laird Technologies, Inc.**, St. Louis,
MO (US)

FOREIGN PATENT DOCUMENTS

WO WO98/54942 12/1998

(**) Term: **14 Years**

OTHER PUBLICATIONS

(21) Appl. No.: **29/244,957**

U.S. Appl. No. 29/224,131, filed Feb. 25, 2005, Latawiec et al.

(22) Filed: **Dec. 16, 2005**

(Continued)

(51) **LOC (8) Cl.** **14-02**
(52) **U.S. Cl.** **D14/432**
(58) **Field of Classification Search** D14/438-39,
D14/432, 435-36; 439/939, 607, 159, 160,
439/946, 630, 152; 174/35 R, 51, 35 C,
174/35 GC, 378, 384, 387, 363, 372, 382,
174/390, 366, 377, 354, 371, DIG. 34, DIG. 35;
361/816, 800, 752, 797, 818, 801, 736, 810,
361/756, 795; 29/832, 840-1; D13/173,
D13/199; 220/4.02

Primary Examiner—M. H. Tung
Assistant Examiner—Susan Moon Lee
(74) *Attorney, Agent, or Firm*—Harness, Dickey & Pierce,
P.L.C.

See application file for complete search history.

(57) **CLAIM**

We claim the ornamental design for a frame for an EMI shield assembly, as shown and described.

(56) **References Cited**

DESCRIPTION

U.S. PATENT DOCUMENTS

1,257,502 A 2/1918 Leighton
2,016,225 A 10/1935 Bukolt
4,705,916 A 11/1987 Wadhwa et al.
4,754,101 A 6/1988 Stickney et al.
4,821,145 A * 4/1989 Corfits et al. 361/692
5,008,779 A 4/1991 Salmon
5,095,177 A 3/1992 Johnson
5,153,379 A 10/1992 Guzik et al.
D331,396 S 12/1992 Benck et al.
5,175,395 A 12/1992 Moore

FIG. 1 is a reduced outer perspective view of the frame for an EMI shield assembly showing our new design;
FIG. 2 is a reduced inner perspective view thereof;
FIG. 3 is a top plan view thereof;
FIG. 4 is a bottom plan view thereof;
FIG. 5 is a front elevation view thereof;
FIG. 6 is a rear elevation view thereof;
FIG. 7 is a left side elevation view thereof; and,
FIG. 8 is a right side elevation view thereof.

1 Claim, 5 Drawing Sheets

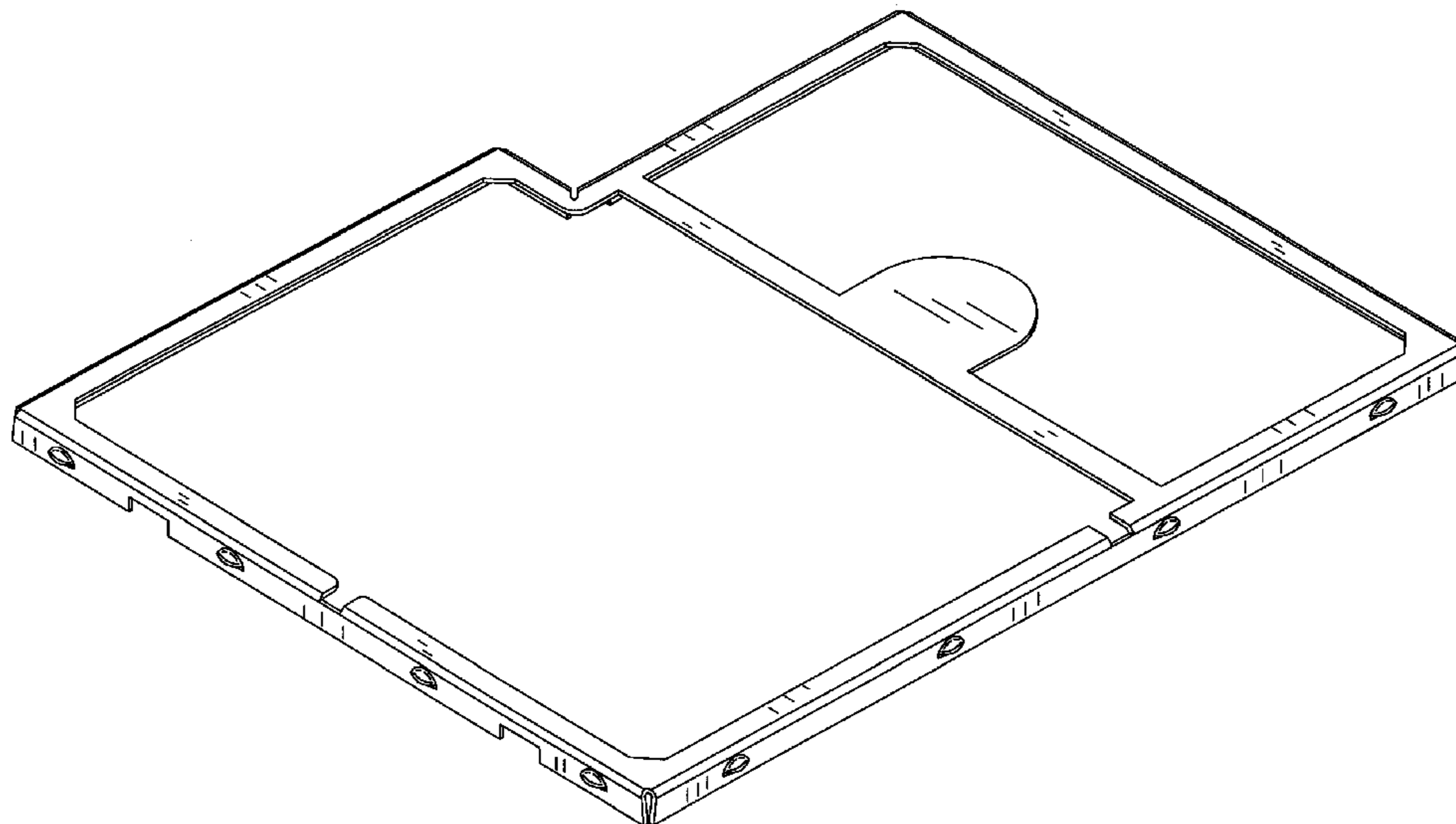

US D549,706 S

U.S. PATENT DOCUMENTS

5,469,982	A	11/1995	Gordecki et al.	6,501,016	B1 12/2002 Sosnowski
5,495,399	A	2/1996	Gore et al.	6,552,261	B2 4/2003 Shlahlichman et al.
5,513,996	A	5/1996	Annerino et al.	6,628,524	B1 9/2003 Washino et al.
5,530,202	A	6/1996	Dais et al.	6,629,860	B1 10/2003 Hu et al.
5,550,713	A *	8/1996	Pressler et al. 361/818	6,636,428	B2 10/2003 Follmer et al.
5,566,055	A	10/1996	Salvi, Jr.	D484,508	S 12/2003 Crippen et al.
5,614,694	A	3/1997	Gorenz, Jr. et al.	6,671,183	B2 12/2003 Tsuzuki
5,774,334	A	6/1998	Kawamura et al.	6,674,653	B1 1/2004 Valentine
5,774,344	A	6/1998	Casebolt	6,711,032	B2 3/2004 Sommer
D397,097	S	8/1998	McNally	6,717,799	B2 4/2004 Hamano et al.
5,844,784	A	12/1998	Moran et al.	6,731,518	B2 5/2004 Suzuki et al.
5,886,879	A	3/1999	Matuschik	6,738,265	B1 5/2004 Svarfvar et al.
5,895,884	A	4/1999	Davidson	6,743,975	B2 6/2004 Kolb
5,917,710	A	6/1999	Maatta	6,744,640	B2 6/2004 Reis et al.
5,991,165	A	11/1999	Jones, Jr. et al.	6,763,576	B2 7/2004 Watchko et al.
6,005,186	A	12/1999	Bachman	6,780,056	B1 * 8/2004 Neidich 439/607
6,043,983	A	3/2000	Taylor et al.	6,781,847	B2 8/2004 Jakob et al.
6,049,469	A	4/2000	Hood, III et al.	6,781,851	B2 8/2004 Daoud et al.
6,051,781	A	4/2000	Bianca et al.	6,784,363	B2 8/2004 Jones
6,110,563	A	8/2000	Pienimaa et al.	6,787,696	B2 9/2004 Liljevik et al.
6,121,545	A	9/2000	Peng et al.	6,870,091	B2 3/2005 Seidler
6,136,131	A	10/2000	Sosnowski	6,949,706	B2 9/2005 West
6,137,692	A	10/2000	Venant	7,004,771	B1 2/2006 Lee
6,150,606	A	11/2000	Matsumoto et al.	7,013,558	B2 3/2006 Bachman
6,152,779	A	11/2000	Madsen et al.	7,147,495	B2 12/2006 Kuo
D434,771	S	12/2000	Ohtani	2002/0185294	A1 12/2002 Shlyakhtichman et al.
6,169,665	B1	1/2001	Lepping et al.	2003/0011978	A1 1/2003 Moore
6,169,666	B1 *	1/2001	Venant 361/816	2003/0016519	A1 1/2003 Bachman
6,175,077	B1	1/2001	Mendolia et al.	2003/0062179	A1 4/2003 West
6,178,097	B1	1/2001	Hauk, Jr.	2003/0067757	A1 4/2003 Richardson et al.
6,191,950	B1	2/2001	Cox et al.	2003/0128535	A1 7/2003 Otani et al.
6,265,658	B1	7/2001	Silvers	2004/0012939	A1 1/2004 Ta et al.
6,274,808	B1	8/2001	Cercioglu et al.	2004/0025334	A1 2/2004 Wen et al.
6,288,330	B1	9/2001	Chen	2005/0121212	A1 6/2005 English et al.
6,313,400	B1	11/2001	Mosquera et al.	2006/0012969	A1 1/2006 Bachman
6,320,121	B1	11/2001	Honeycutt et al.		
6,377,472	B1	4/2002	Fan		
6,384,324	B2	5/2002	Flegeo		
6,421,252	B1 *	7/2002	White et al. 361/797		
6,483,719	B1	11/2002	Bachman		

OTHER PUBLICATIONS

U.S. Appl. No. 11/245,306, filed Oct. 6, 2005, Zuehlsdorf et al.

* cited by examiner

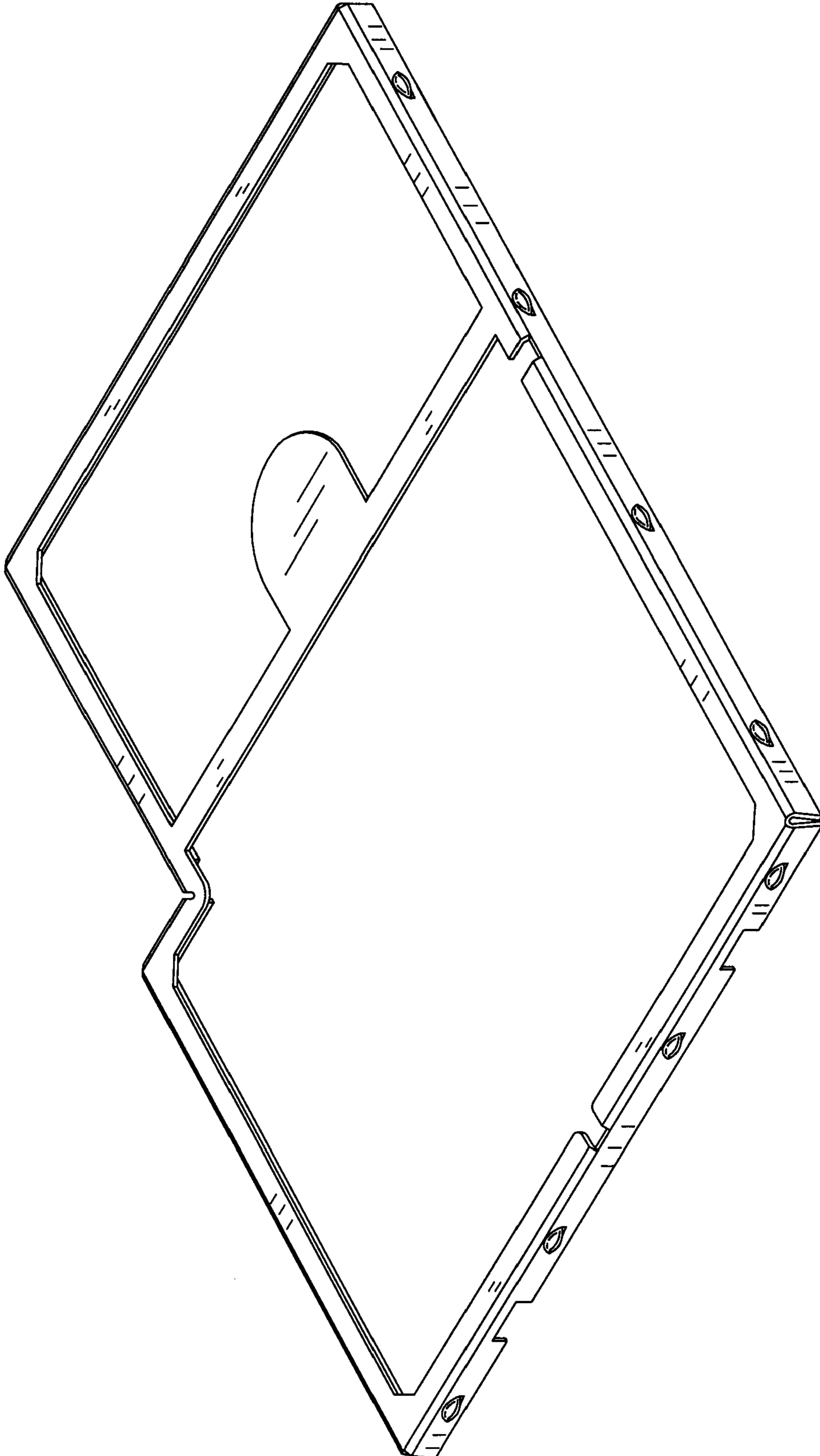

FIG. 1

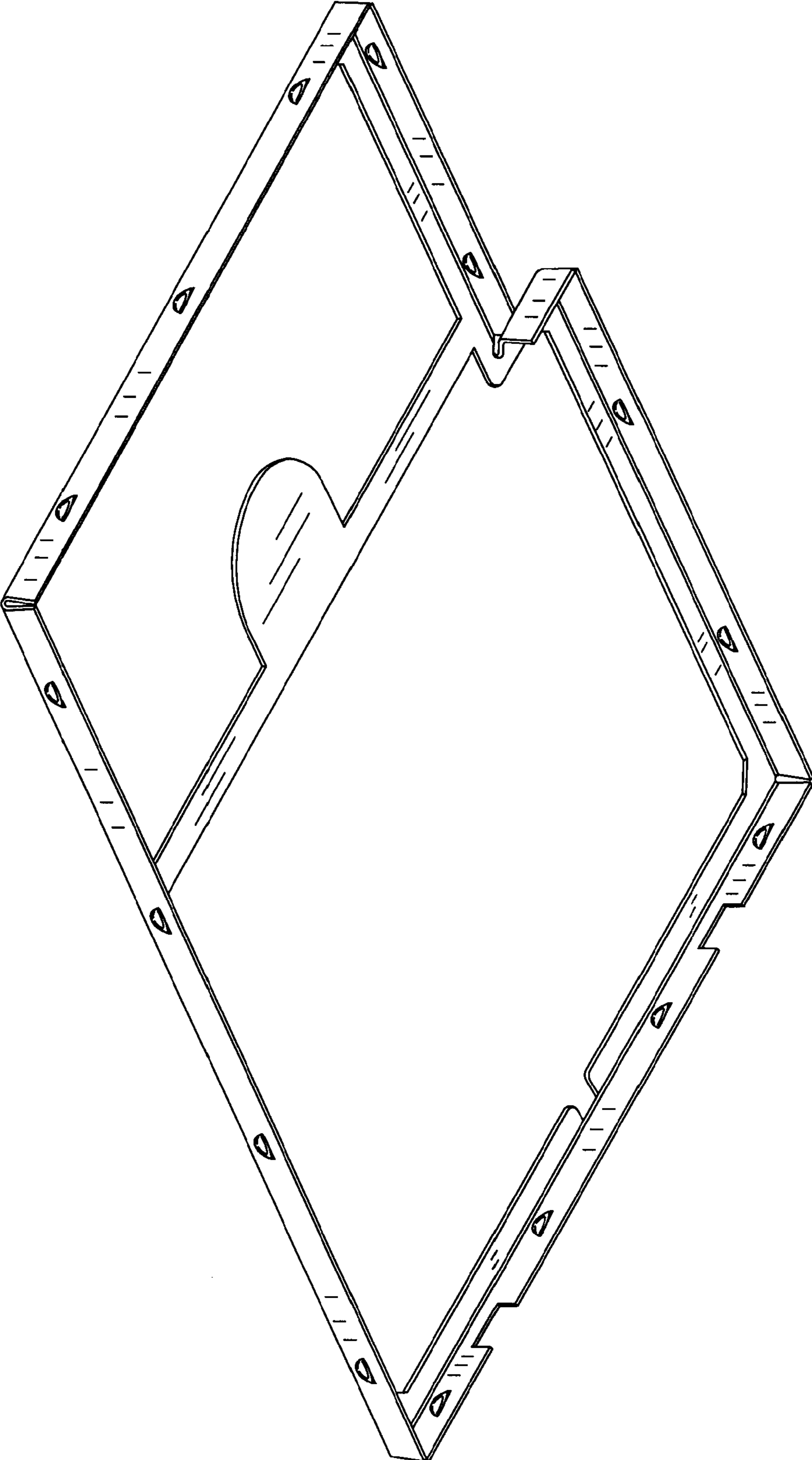

FIG. 2

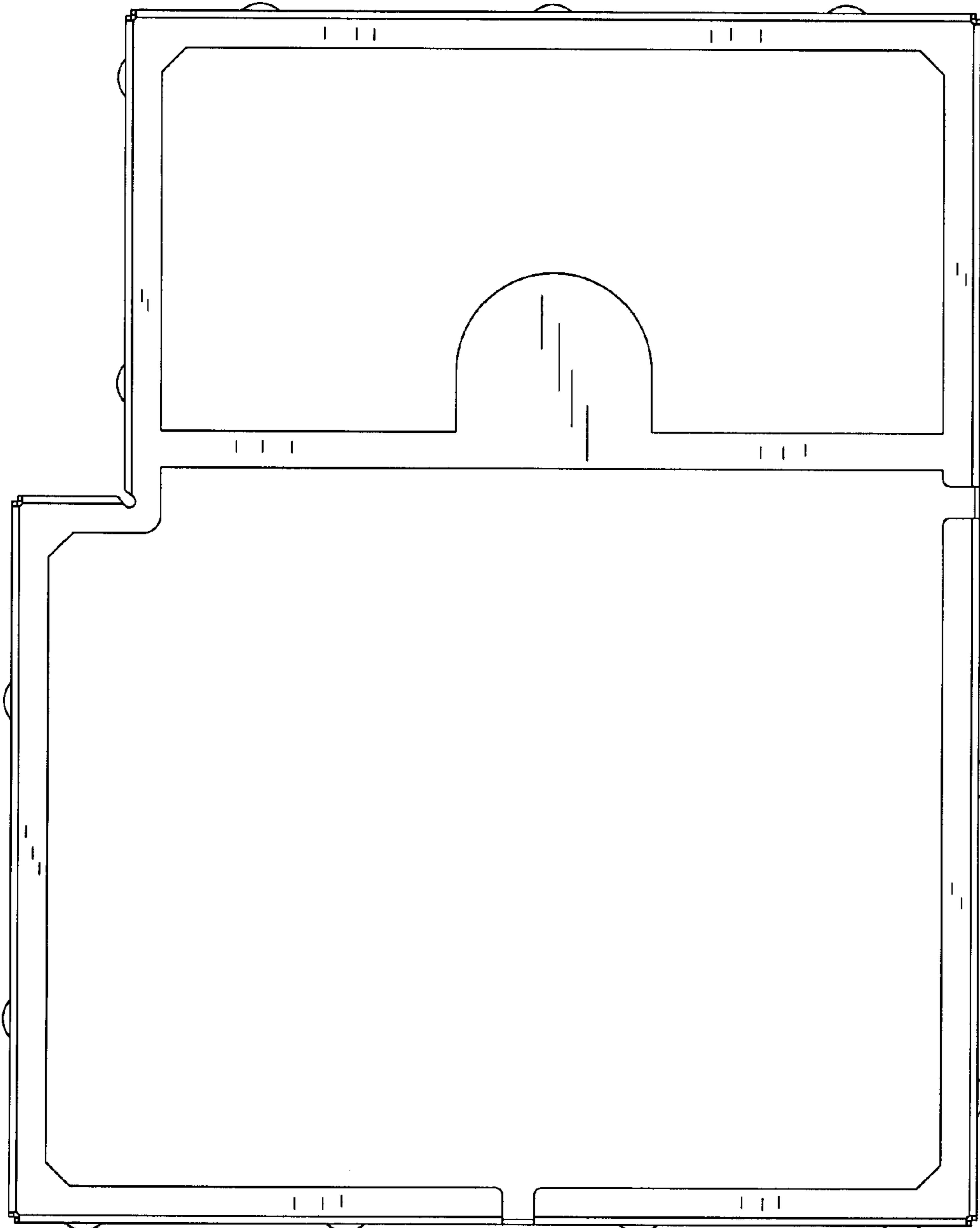

FIG. 3

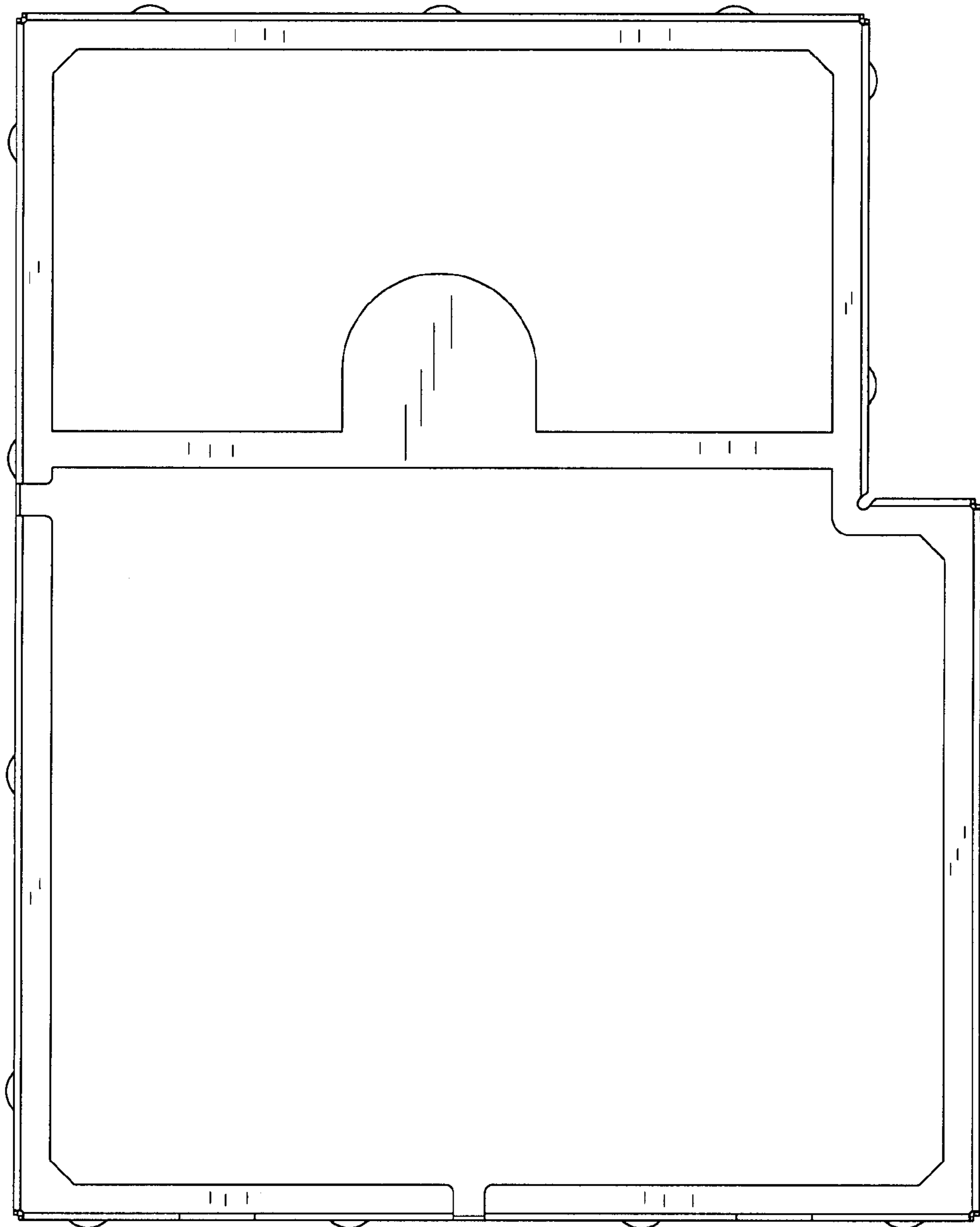

FIG. 4

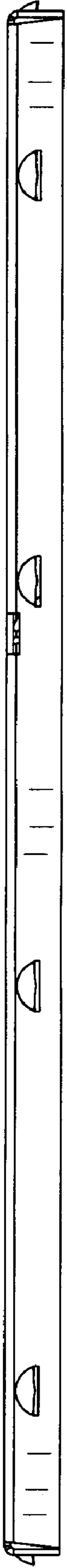

FIG. 5

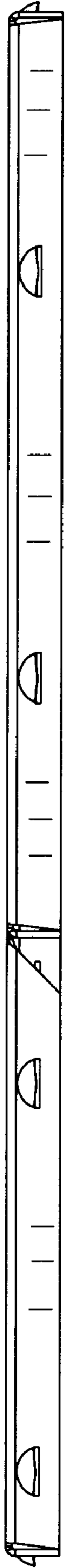

FIG. 6

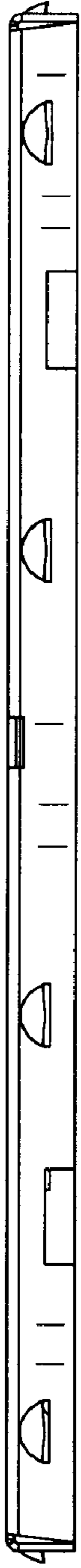

FIG. 7



FIG. 8